



get in harmony with nature



tender rain®

“L’acqua è l’origine di tutto,  
entità, primordiale ed eterna,  
da cui tutto proviene per  
generazione spontanea e a cui  
tutto torna dissolvendosi.

L’acqua è dunque all’origine  
del mondo, l’unità fondamentale  
nascosta dietro la molteplicità  
delle cose in divenire”.

(Talete 624-546 a.C)

A photograph of a rocky waterfall. The water is cascading down a series of dark, jagged rock formations. The rocks are covered in patches of green moss and small plants, including some ferns and grasses. The scene is illuminated by bright sunlight, creating strong highlights and deep shadows. The overall atmosphere is natural and serene.

“Water constitutes the principle of all things, primordial and eternal entity, from which all things originate spontaneously and to which all things come back and dissolve. Water is the origin of the world, the fundamental unity which lies hidden behind the multiplicity of the changes.” Thales

“L'eau constitue le principe de toutes choses, entité primordiale et éternelle, à partir de laquelle tout a origine spontanément et à laquelle tout revient et se dissout. L'eau est l'origine du monde, l'unité fondamentale cachée derrière la multiplicité des changements”. Thalès

Thales behauptete „Ursprung und Ende des Alls sei das Wasser; denn aus Wasser, sei es in festem, sei es in flüssigem Zustand, bestehe das Universum, und es schwebte auf dem Wasser.“ Er meinte, Wasser sei Ursprung der Welt, die unterliegende Einheit versteckt hinter der Vielfalt der Dinge zu kommen.

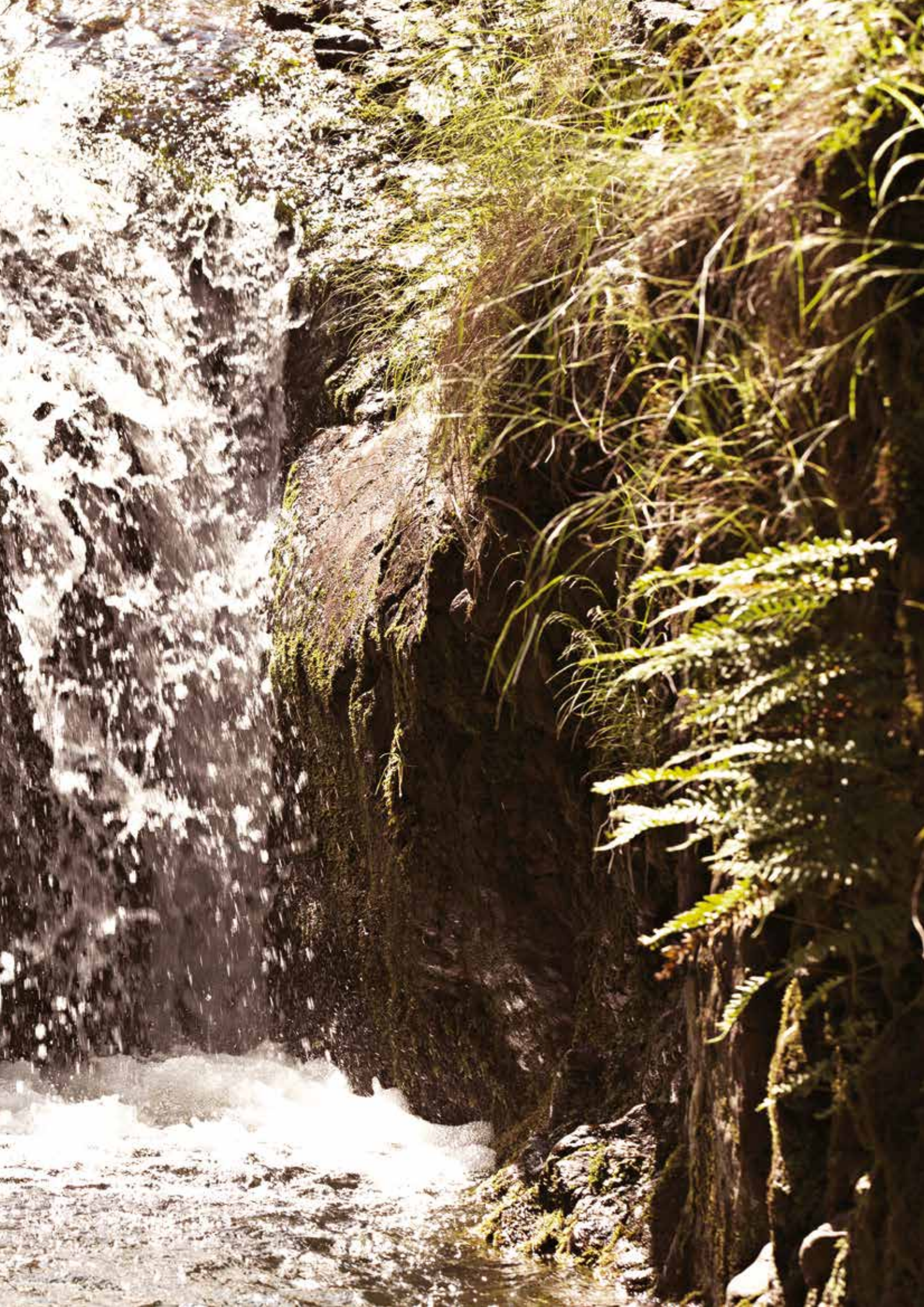



## Punti forti dei prodotti tender rain®

- 100% made in Italy
- materie prime **atossiche** e certificate
- risparmio idrico e risparmio energetico
- sistema antisedimentazione
- totale ispezionabilità
- getto tonificante anche a bassa pressione: da 0,5 bar
- facilità di installazione e manutenzione
- adattabilità a impianti preesistenti
- dispositivo di rapido fissaggio per installazioni a controsoffitto
- possibilità di personalizzazioni
- installazione indoor e outdoor
- design esclusivo
- ampia scelta di finiture





### Key points of tender rain® products:

- 100% made in Italy
- certified and **non-toxic** raw materials
- water and energy saving
- no water sedimentation
- inspectability
- invigorating shower also under low pressure
- easy installation and maintenance
- easy to adapt to the existing plumbing
- quick-fixing device for false ceiling installation
- on demand customization
- suitable for indoor and outdoor
- exclusive design
- wide choice of finishes

### Principales caractéristiques des produits tender rain®:

- produits 100% italiens
- matières premières certifiées **non toxiques**
- consommation économique d'eau et d'énergie
- système anticalcaire sans rétention d'eau
- possibilité d'inspection
- jet tonique même à basse pression: à partir de 0,5 bar
- facilité d'installation et d'entretien
- adaptabilité aux installations préexistantes
- dispositif de fixation rapide pour l'installation au contre-plafond
- possibilité de personnalisation
- installation à l'intérieur et à l'extérieur
- design exclusif
- disponibilité de plusieurs finitions

### Diese sind die wesentlichen Eigenschaften der tender rain® Produkte:

- 100% italienische Produkte
- aus zertifizierten und **ungiftigen** Materialien
- Wasserersparnis und Energieersparnis
- Anti-Bodensatzsystem
- totale Prüfbarkeit
- tonisierender Wasserstrahl auch bei niedrigem Druck: ab 0,5 bar
- mühelose Montage und Instandhaltung
- Anpassung an existierende Systeme
- Vorrichtung für schnelle Montage an Blenden Decken
- Personalisierungsmöglichkeiten
- Indoor-und Outdoormontage
- exklusives Design
- große Auswahl an Oberflächen

A Nord Est del Piemonte, in Valduggia, piccola realtà abitativa ricca di storia, di arte e operosità, ha sede l'azienda produttrice degli articoli a marchio **tender rain**<sup>®</sup>.

Fondata negli anni '70 da Giovanni Maria Mazzola quale naturale differenziazione della plurisecolare attività familiare - *fonderia di campane* - iniziata nel 1400 e proseguita fino al nostro secolo, costituisce oggi una realtà antesignana e di riferimento per il settore docce. Nel corso degli anni ha sviluppato tecnologie d'avanguardia avvalendosi di una consolidata esperienza, di una rigorosa e costante ricerca e di un parco macchine di ragguardevole consistenza e di alta tecnologia. Tali requisiti consentono di realizzare progetti innovativi finalizzati a vestire il proprio know-how tecnologico con un design rivoluzionario e di classe. I prodotti tender rain<sup>®</sup> sono italiani al 100% e vantano il primato del minimalismo razionale, supportato da un sistema costruttivo brevettato, grazie al quale i prodotti risultano dotati di vantaggiose caratteristiche tecnico-funzionali. Con essi l'ambiente bagno acquista non solo eleganza, prestigio e modernità, ma diventa spazio dedicato al benessere personale. La concreta volontà di muoversi in un contesto di "creatività tecnologica" finalizzata alla totale soddisfazione dell'utenza è la prioritaria vocazione aziendale che ambisce a coniugare forma e funzione con innovazione, qualità e design.

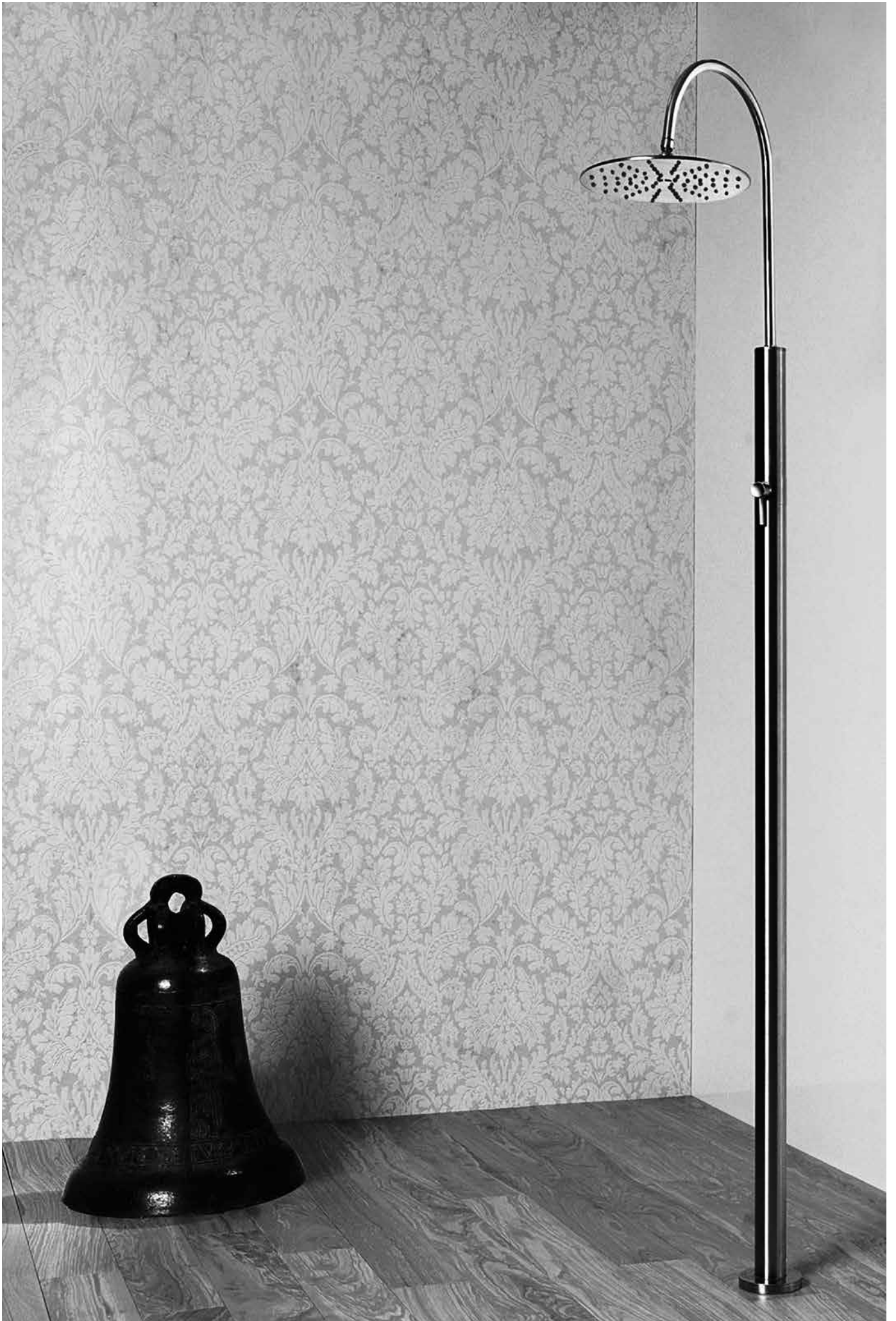



**tender rain®** is located in Northeast Piedmont, in Valduggia, a small town steeped in history, art and industry. The company was founded in the 70s by Giovanni Maria Mazzola, whose family had hundreds of years of experience in the metallurgical sector with a well-established bell foundry. tender rain® is at present an innovative business in the shower field. Over the years, it has developed pioneering technologies, wide experience, constant research and a modern machinery inventory. These features allow to finalize important projects and to combine technological know-how together with revolutionary design. tender rain® works in a technological creative atmosphere to ensure a complete customer satisfaction.

**tender rain®** est située dans le nord du Piémont, à Valduggia, une petite ville riche en histoire, art et industrie. La société a été fondée dans les années 1970 par Giovanni Maria Mazzola, dont la famille avait plus de cinq siècles d'expérience dans le domaine métallurgique grâce à sa fonderie de cloches. tender rain® est actuellement une entreprise innovante dans le domaine de la salle de bain. Au fil des ans, nous avons développé des technologies d'avant-garde, une remarquable expérience, une recherche technique constante et des machines évoluées. Nos produits sont 100% italiens, ils possèdent la primauté d'une forme minimaliste et rationnelle et un système constructif breveté. Ces caractéristiques sont destinées à la satisfaction et au bien-être de la clientèle finale.

Im Nordwesten von Piemont, in der kleinen, historischen Stadt von Valduggia, bekannt für ihre Kunst und ihre Arbeitsamkeit, ist die Herstellungsfirma der **tender rain®** Produkte zu Hause. In den 1970er Jahren von Giovanni Maria Mazzola als natürliche Folge des Familiengeschäfts in Glockengießen gegründet, das seit 1400 bis zu diesem Jahrhundert im Geschäft arbeitete, ist tender rain® heute ein Wegbereiter und Referenzpunkt für den Duschsektor. Über die Jahre hat die Firma eine avantgardistische Technologie entwickelt, die Nutzen aus der langen Erfahrung, aus einer rigorosen und kontinuierlichen Forschung und einer high-tech Maschinerie zieht. Diese Bedingungen ermöglichen es, innovative und zielgerichtete Projekte durchzuführen, in denen technologisches Know-how mit revolutionärem Design der hohen Klasse zusammenkommt. Die tender rain® Produkte sind stolz auf ihren maßgeblichen, rationalen Minimalismus, der durch ein patentiertes Bausystem unterstützt wird, durch das die Produkte über vorteilhafte technisch-funktionale Eigenschaften verfügen. Und außerdem sind sie 100% Made in Italy. Mit diesen Produkten, gewinnt ein Badezimmer nicht nur an Eleganz, Prestige und Modernität, sondern es entsteht auch ein Raum, der dem persönlichen Wellness gewidmet ist. Der Wunsch, sich in einer Umgebung von „kreativer Technologie“ zu bewegen, der totalen Zufriedenheit der Benutzer gewidmet, ist das erste Prinzip der Firma tender rain®, mit dem Ziel, Form und Funktion mit Innovation, Qualität und Design zusammen zu bringen.



MAIOR CONITIS MAESIS

LAPIDUM

S. VITTORE -  
AD UNA FEDE CORACKISA  
DE TEMPESTATE MORTE BELLO  
LORRELLA - DICONCELLI FELICE  
A.D. 1991



Plurisecolare attività familiare - *fonderia di campane* - iniziata nel 1400 e proseguita fino al nostro secolo.

Family business with hundreds of years of experience - bell foundry - which started in the 15th century and continued up to the 21st century.

Activité familiale avec plusieurs centaines d'années d'expérience - fonderie de cloches - commencée au 15ème siècle et continuée jusqu'à notre siècle.

Familiengeschäft in Glockengießen, das seit 1400 bis zu diesem Jahrhundert im Geschäft arbeitete.

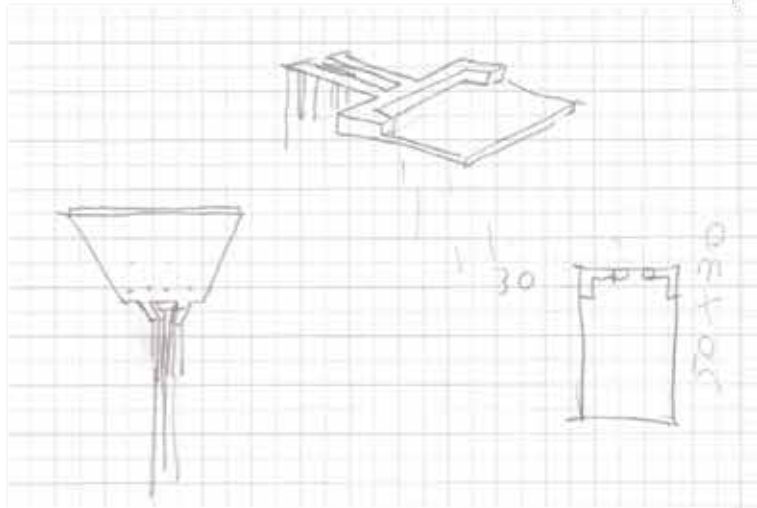
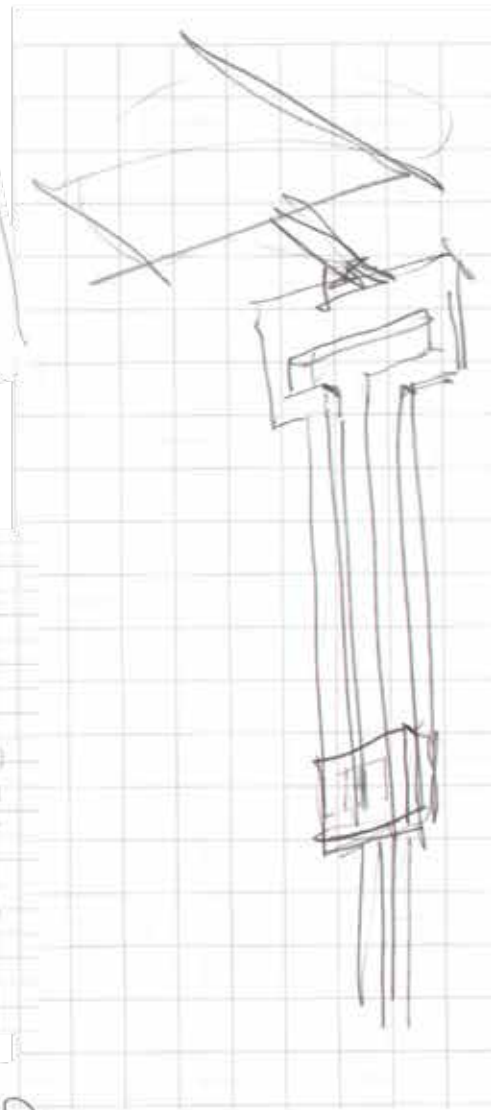
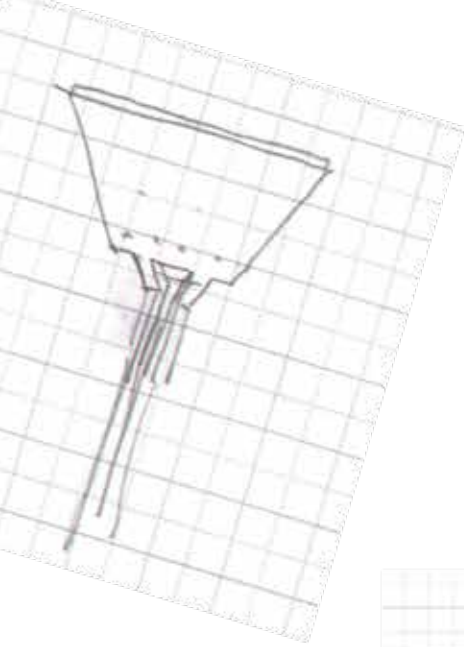

Handwritten text: *Handwritten text, possibly a signature or name, written in a cursive style.*

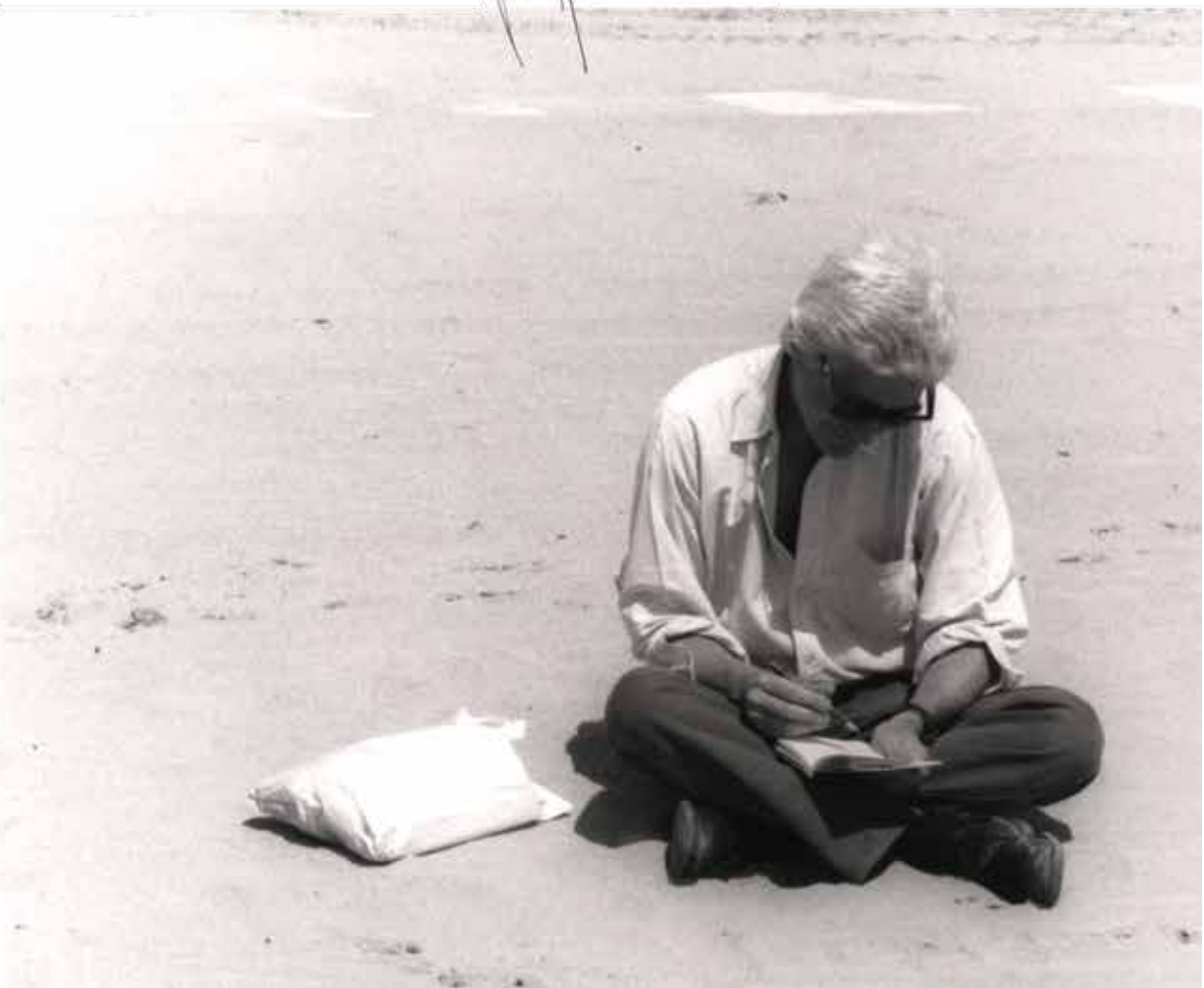
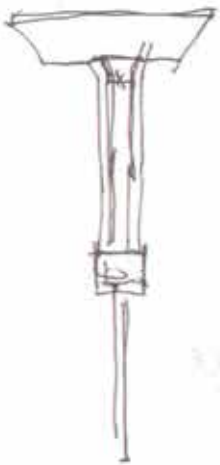
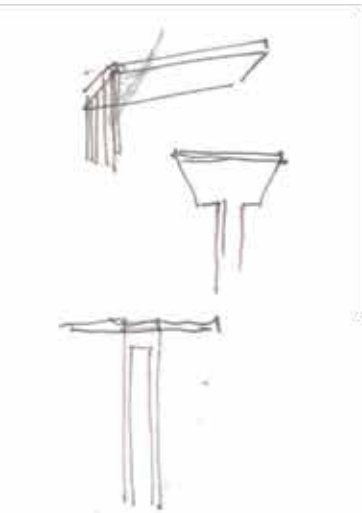



Arch. Luca Scacchetti, lo storico interprete della creatività di **tender rain**<sup>®</sup>

“Il rapporto tra le superfici pulite, riflettenti ed assolute del metallo e l’acqua, con la sua trasparenza, il suo essere massa fluida in movimento, ha governato i miei progetti per le docce **tender rain**<sup>®</sup>.”

La staticità architettonica del corpo erogante e la naturalità scomposta del liquido ha guidato le mie linee finalizzate a fissare sempre più gli elementi come steli, segni archetipi, architetture o frammenti di architetture; pilastri, sottili reticoli, travi, segni pseudo simbolici. In questa esaltazione del contrasto tra la fissità monumentale dell’architettura, l’elemento erogante e la morbidezza sfavillante dell’acqua, la tecnologia si nasconde o si mostra il meno possibile, per essere riassunta o assorbita dalla forza delle linee strutturali.”

*Luca Scacchetti*

“My projects for **tender rain**<sup>®</sup> showers are inspired by the relationship between metal – with its clean and shiny surfaces, and water – with its transparency and fluidity. The contrast given by the imposing architecture of the main body and the natural liquid led my lines and generated stems, archetypal signs, architectural fragments, networks and symbols. Within this opposition, technology is almost hidden, it shows itself as little as possible and gets absorbed by strong structural lines.”

Luca Scacchetti

“Mes projets pour les douches **tender rain**<sup>®</sup> sont inspirés par la relation entre le métal - avec ses surfaces propres et brillantes, et l'eau - avec sa transparence et fluidité. Le contraste entre l'architecture imposante du corps principal et l'élément liquide a guidé mes lignes et a généré signes archétypaux, fragments architecturaux, réseaux et symboles. Dans cette opposition, la technologie est presque cachée, elle se montre aussi peu que possible et est absorbée par de fortes lignes structurelles.”

Luca Scacchetti

“Die Beziehung zwischen sauberen widerspiegelnden Metalloberflächen und Wasser, mit seinem Transparenz, seinem Wesen als bewegte Flüssigkeit, war der Leitfaden für alle meiner Projekte für **tender rain**<sup>®</sup>-Duschen. Der Bezug zwischen der architektonischen Stasis des Wasserspenders und der unordentlichen Natürlichkeit des Fluidums hat meine Linien mit dem Ziel gelenkt, die Elemente wie Schäfte, Archetypen, Architektur oder auch nur Bruchstücke davon, Säulen, dünne Gitter, Leisten und Pseudo-symbolisches immer mehr festzuhalten. In dieser Betonung des Kontrasts zwischen der Fixität der Architektur und des Apparats und der flimmernden Weichheit des Wassers ist die Technologie versteckt, oder nur selten zu erkennen, und sie wird von der Stärke der Strukturlinieneingegliedert oder absorbiert,” so Luca Scacchetti.



Oggi, poiché tutti sappiamo che l'acqua è un bene prezioso da utilizzare correttamente per la sopravvivenza di tutti gli ecosistemi, dell'uomo e delle sue attività produttive fondamentali, non può essere solo auspicabile, ma è **doveroso** assumere un comportamento sia ecosostenibile, cioè mirato a dosare il consumo delle risorse naturali in modo da garantire ai posteri la nostra stessa possibilità d'uso, sia ecocompatibile, cioè finalizzato a mantenere la qualità e la riproducibilità delle risorse naturali. L'etica aziendale di tender rain®, basata sul rispetto della natura e del suo inestimabile patrimonio, ha infatti motivato la ricerca di soluzioni costruttive mirate al raggiungimento di obiettivi ecologici quali: risparmio idrico ed energetico, impiego di materiali certificati, effetto pioggia che abbraccia la silhouette e converge in uno stimolante e salutare massaggio, ossigenazione dell'acqua a beneficio della pelle. 'Salus per aquam' nella tua SPA, ossia costante benessere generato da prodotti appositamente progettati e qualitativamente INECCEPIBILI.



Nowadays we are all aware that water constitutes a precious resource and it must be preserved to ensure the outliving of all ecosystems, human beings and fundamental activities. Therefore, it is not only desirable but also necessary to adopt an eco-friendly and environmentally sustainable behaviour in order to preserve natural resources and to grant their continuity. Our corporate ethics is based on a total respect of natural patrimony and it aims at manufacturing solutions able to pursue ecological objectives: water and energy saving, certified raw materials, uniform **tender rain**<sup>®</sup> effect ensuring an amazing massage. Our high quality showers represent your personal SPA solution, 'salus per aquam' meaning well being through water.



Aujourd'hui, nous sommes tous conscients que l'eau représente une ressource précieuse et elle doit être préservée pour assurer la sauvegarde des écosystèmes. Par conséquent, il est non seulement souhaitable mais aussi nécessaire d'adopter un comportement respectueux de l'environnement afin de préserver les ressources naturelles et leur continuité. Notre éthique d'entreprise est fondée sur le respect total du patrimoine naturel et elle vise à produire des solutions capables de poursuivre des objectifs écologiques: consommation à économie d'eau et d'énergie, matières premières certifiées et bien-être. Nos douches de haute qualité représentent une solution de SPA personnelle: «salus per aquam» signifie «santé par l'eau».

Wasser ist ein Gut, das für das Überleben aller Ökosysteme der Erde, der Menschen und aller seiner fundamentalen Produktionsaktivitäten, in korrekter Weise zu gebrauchen ist. Im Hinblick darauf ist ein umweltverträgliches Benehmen heute nicht nur wünschenswert, sondern sogar gebührend, das heißt, die natürlichen Ressourcen so zu verwenden, dass ein ähnliches Gut für die folgenden Generationen bleibt, aber auch ökokompatibel, das heißt, dass die Qualität und Wiederherstellbarkeit der natürlichen Ressourcen erhalten bleibt. Die Firmenethik bei **tender rain**®, basiert auf Respekt für die Natur und das unschätzbare Erbe, war tatsächlich dazu die Motivation, Forschung zu betreiben, die darauf gerichtet ist, ökologische Ziele zu erreichen wie z.B. Wasser- und Energieersparnisse, Anwendung von zertifizierten Rohmaterialien, Regenduschen, die den Körper einhüllen und auf stimulierende und gesunde Art massieren, und sauerstoffangereichertes Wasser für gesunde Haut. "Salus per aquam" sagt schon alles: kontinuierliches Wohlbefinden durch Produkte, die qualitativ tadellos und entsprechend entworfen sind.





emisfero  
36



sharp  
46



arethusa  
78



pluvia  
64





90 jetto



104 menhir



116 calices



126 pigreco



emisfero

36



sharp

46

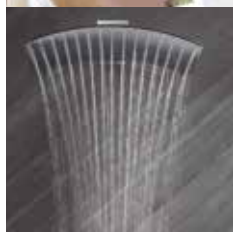

pluvia

64

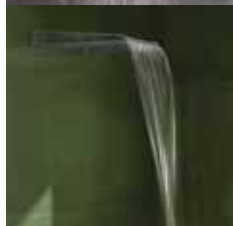

arethusa

78



jetto

90



menhir

104

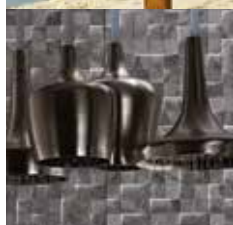

calices

116



pigreco

126

 tender rain®

design Luca Scacchetti

*soffione  
shower head  
pomme de tête  
Kopfbrause*

*cascata  
waterfall  
cascade  
Wasserfall*

*colonna da muro  
wall mounted  
murale  
Wandmontage*

*colonna da terra  
self standing  
sur pieds  
Standmontage*

*cromoterapia  
chromotherapy  
chromothérapie  
Farbtherapie*

*lampadario  
ceiling lamp  
lustre  
Hängelampe*





viceversa

136



duetto C

144



duetto D

148



big rain

154

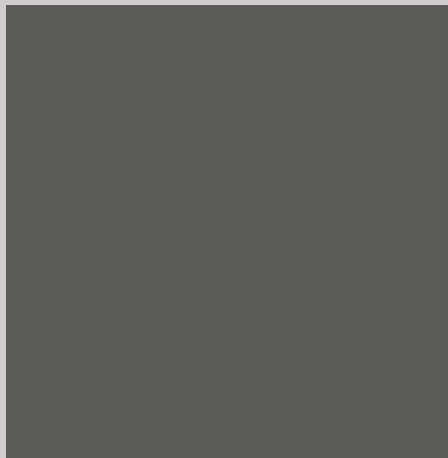

soffioni multifunzione

multifunction shower heads  
pommes de tête multifonction  
multifunktions Kopfbrausen

164



echo

168



cromoterapia

chromotherapy  
chromothérapie  
Farblichttherapie

174

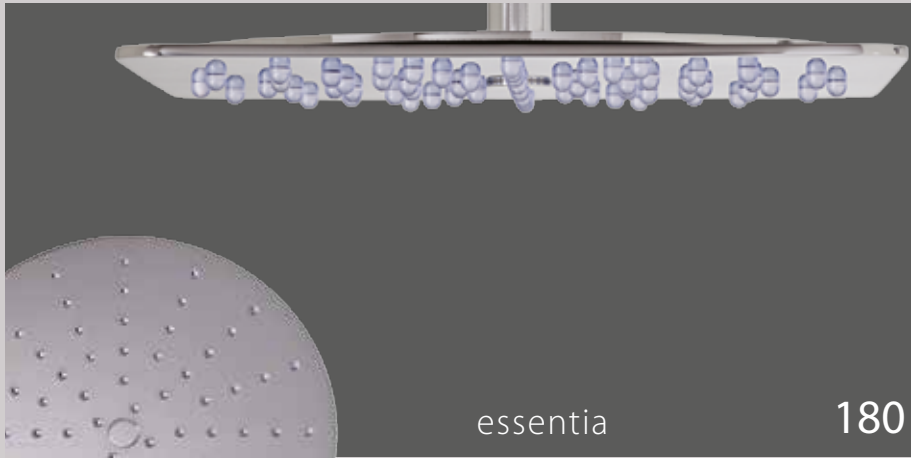

essentia

180



colonne  
rettangolari

rectangular section rising rails  
colonnes rectangulaires  
Rechteckschnitt Duschpaneele

186

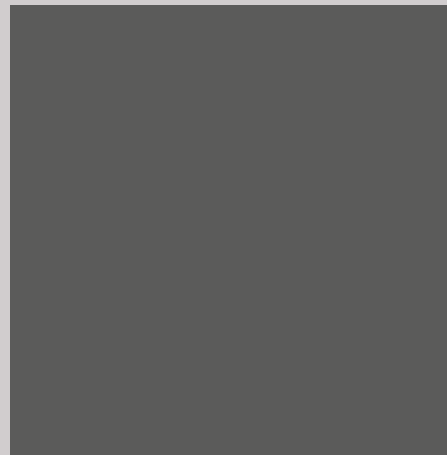

colonne  
cilindriche

round section rising rails  
colonnes cylindriques  
runde Schnitt Duschpaneele

192



echo cascata

echo waterfall  
echo cascade  
echo Wasserfall

198



echo minimale

echo minimal  
echo minimale  
echo minimal

204



echo classica

echo classic  
echo classique  
echo classic

206



saliscendi

sliding bars  
barres coulissantes  
verstellbar Set

208



gruppo vasca  
da terra

freestanding bathtub faucet  
bain douche sur pieds  
Wannenmischer bodenstehend

214



bocca soffitto

ceiling spout  
bec de plafond  
Deckenauslauf

218





emisfero

224



calices

228



formae

234



colonna  
echo retrò

echo retrò rising rail  
colonne echo retrò  
Duschpaneel echo retrò

238



soffione retrò

retrò shower head  
pomme de tête retrò  
Kopfbrause retrò

242



saliscendi retrò

retrò sliding bar  
barre coulissante retrò  
verstellbar Set retrò

242



INOX





petalo romboidale

Petalo rhomboidal model  
Petalo modèle rhomboïdal  
Petalo rhombisches Modell

252



petalo tondo

Petalo round model  
Petalo modèle ronde  
Petalo rundes Modell

258



babordo

264



soffione jetto

jetto shower head  
pomme de tête jetto  
Kopfbrause jetto

270



estante

274



soffione multifunzione

multifunction shower head  
pomme de tête multifonction  
multifunktions Kopfbrause

280



colonna C3

C3 rising rail  
colonne C3  
Duschpaneel C3

284



set da muro

wall mounted shower sets  
sets de douche muraux  
Dusche Set für Wandmontage

286



colonna X0

X0 shower column  
colonne de douche X0  
Duschsäule X0

292



### colonna menhir

menhir rising rail  
colonne menhir  
Duschpaneel menhir



296

### colonna sharp

sharp rising rail  
colonne sharp  
Duschpaneel sharp



306

### colonna R1

R1 rising rail  
colonne R1  
Duschpaneel R1



312

### gruppo lavapiedi

foot-rinse station  
borne rince-pieds  
Mischer bodenstehend



312

### colonna C1

C1 rising rail  
colonne C1  
Duschpaneel C1



316

### colonna C3

C3 rising rail  
colonne C3  
Duschpaneel C3



316

### set a parete menhir

menhir wall mounted set  
set douche murale menhir  
Wandmontage Set menhir



322

### set a parete

wall mounted set  
set douche murale  
Wandmontage Set



322

modello depositato | registered pattern | modèle déposé | eingetragene Design

brevettato | patented | breveté | patentiert

emisfero

*design Luca Scacchetti*





## versione LAMPADARIO

ceiling lamp version also available

disponible aussi en version lustre

Hängelampe ebenfalls verfügbar



# Dalla semplicità della forma, agli scenografici EFFETTI SPECIALI di acqua e di luce.

A simple shape performing an artistic pattern with chromatic water effects.

La forme essentielle donne origine à des effets artistiques d'eau et lumière.

Von der hohlen Kuppel zeigen sich die silbernen Tropfen in einem einhüllenden und artistischen Spiel der Farbeffekte.



## soffione con cromoterapia

chromotherapy shower head | pomme de tête avec chromothérapie | Kopfbrause mit Farbtherapie

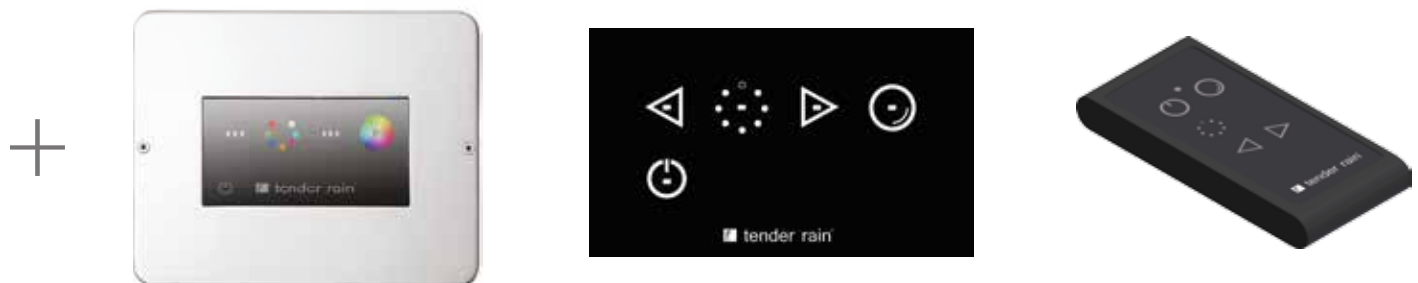

Comandi cromoterapia pagine 178-179

Chromotherapy controllers pages 178-179

Contrôleurs pour chromothérapie pages 178-179

Steuergeräte für Farbtherapie Seiten 178 -179





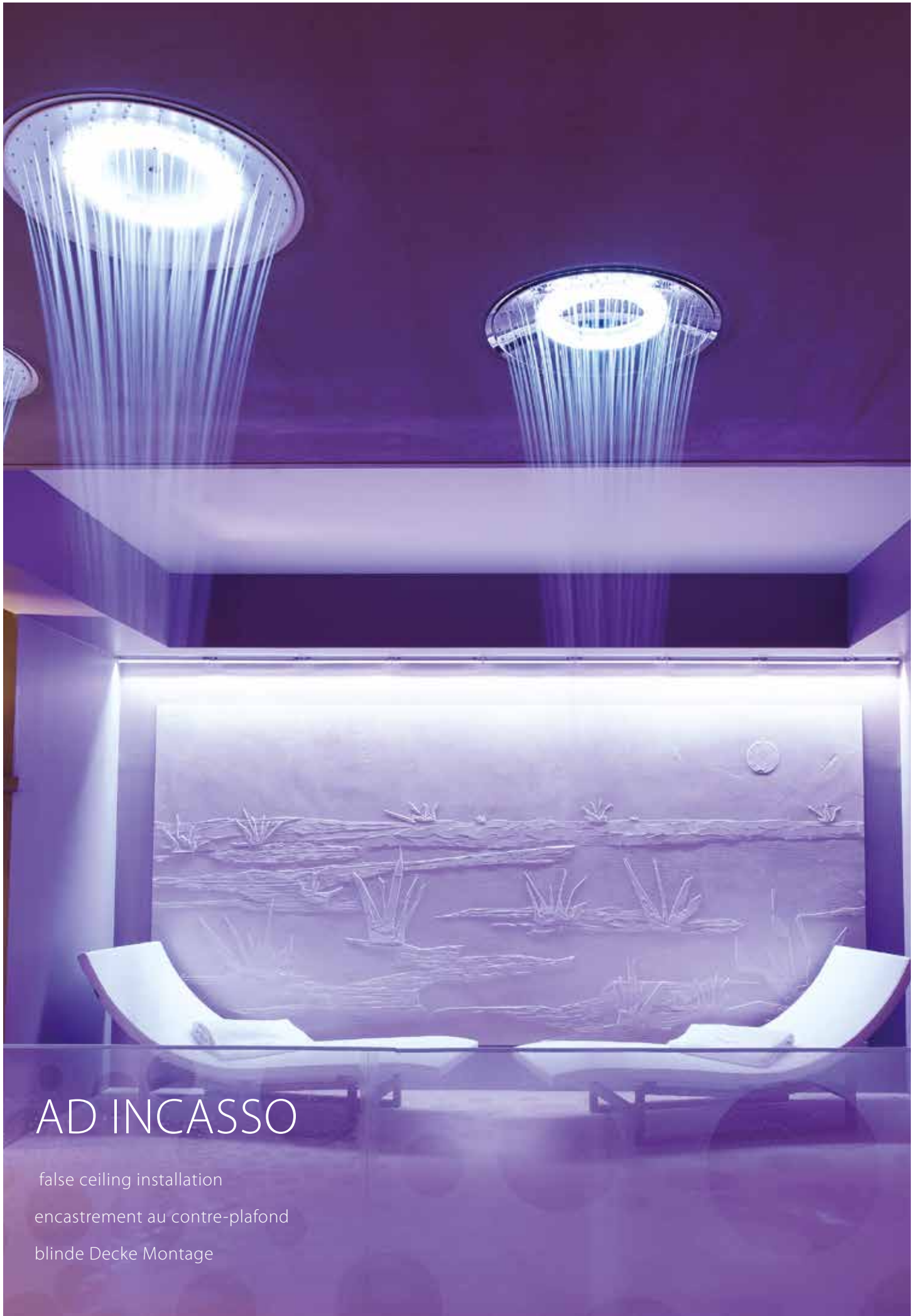

# AD INCASSO

false ceiling installation

encastrement au contre-plafond

blinde Decke Montage

attacco indipendente:  
A SOFFITTO

ceiling water inlet

raccordement au réseau d'eau au plafond

unabhängige Wasseranschluß am Decke



attacco indipendente:  
A PARETE

wall water inlet

raccordement au réseau d'eau murale

unabhängige Wasseranschluß am Wand



## Singularità della forma a volta CELESTE.

Unique shape evoking planetary immensity.

Une forme qui évoque l'immensité planétaire.

Die Einmaligkeit der Form, die die Immensität des Planetariums heraufbeschwört.



sharp

*design Luca Scacchetti*







Riduzione al minimo formale del salire e dello spandersi dell'acqua, *sharp* segna una forma, un PERCORSO LIQUIDO.

The minimal shape of Sharp with its aesthetic of simplicity highlights the artistic water path.

La forme minimale de Sharp souligne l'écoulement artistique de l'eau.

Reduzierung auf ein formales Minimum des Steigens oder Expandierens des Wassers, Sharp ist Symbol einer Form, eine flüssige Bahn.



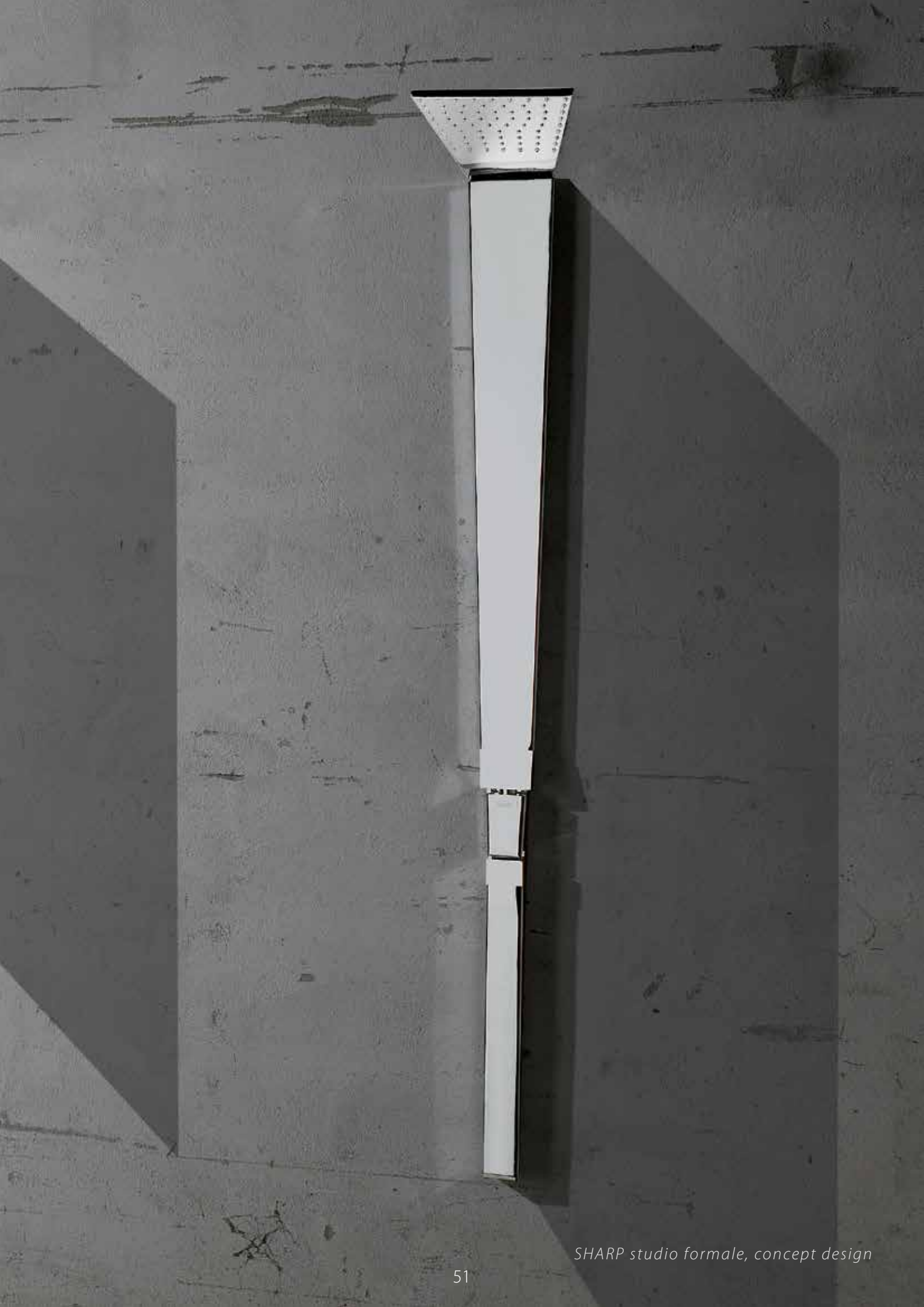

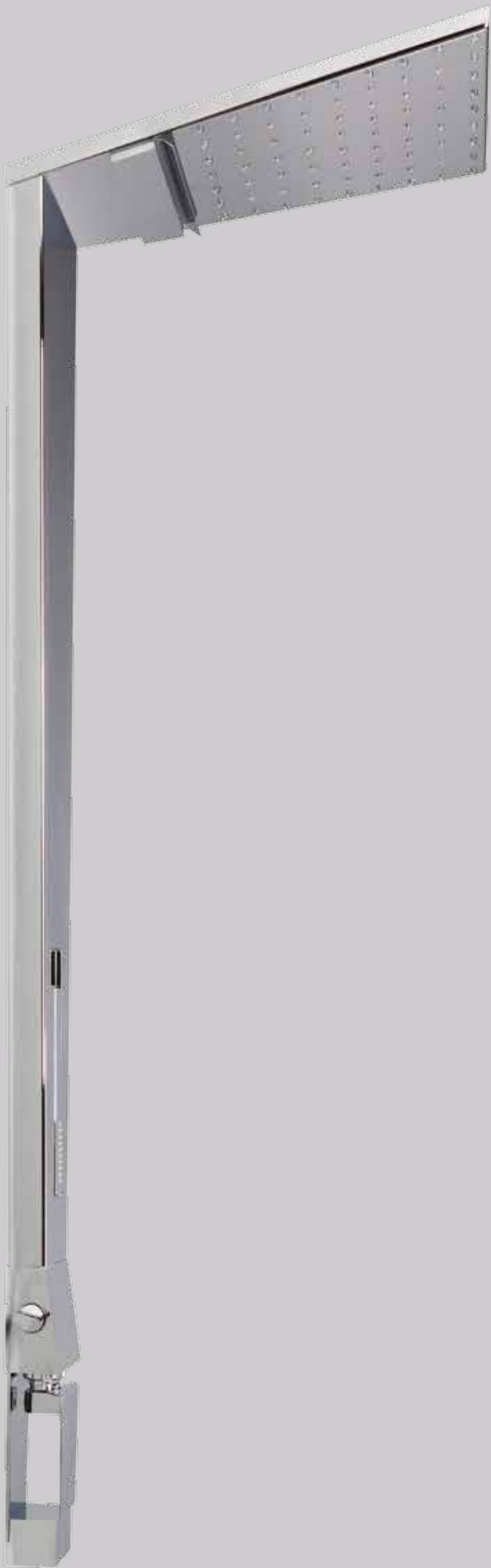





pioggia

rain • pluie • Regen



cascata

waterfall • cascade • Wasserfall



body spray

body spray • jet latéral • Seitenbrause

## MOLTEPLICITÀ FUNZIONALE

MULTIFUNCTION

MULTIFONCTION

MULTIFUNKTIONS



doccetta estraibile

extractable handshower

douchette extractible

ausziehbare Handbrause



SOFFIONE ESSENZIALE,  
ripercorre il profilo che si genera tra  
muro e soffitto, spigolo tra due piani  
che è alla base di ogni architettura.

Minimal shower head which follows the path of wall and ceiling, essential architecture made of edges and flat surfaces.

Objet qui suit les lignes du mur et du plafond, architecture essentielle entre surfaces.

Essentieller Duschkopf, spiegelt das Profil zwischen Wand und Decke wieder, die Kante zwischen zwei Flächen, die die Basis für jede Architektur bildet.



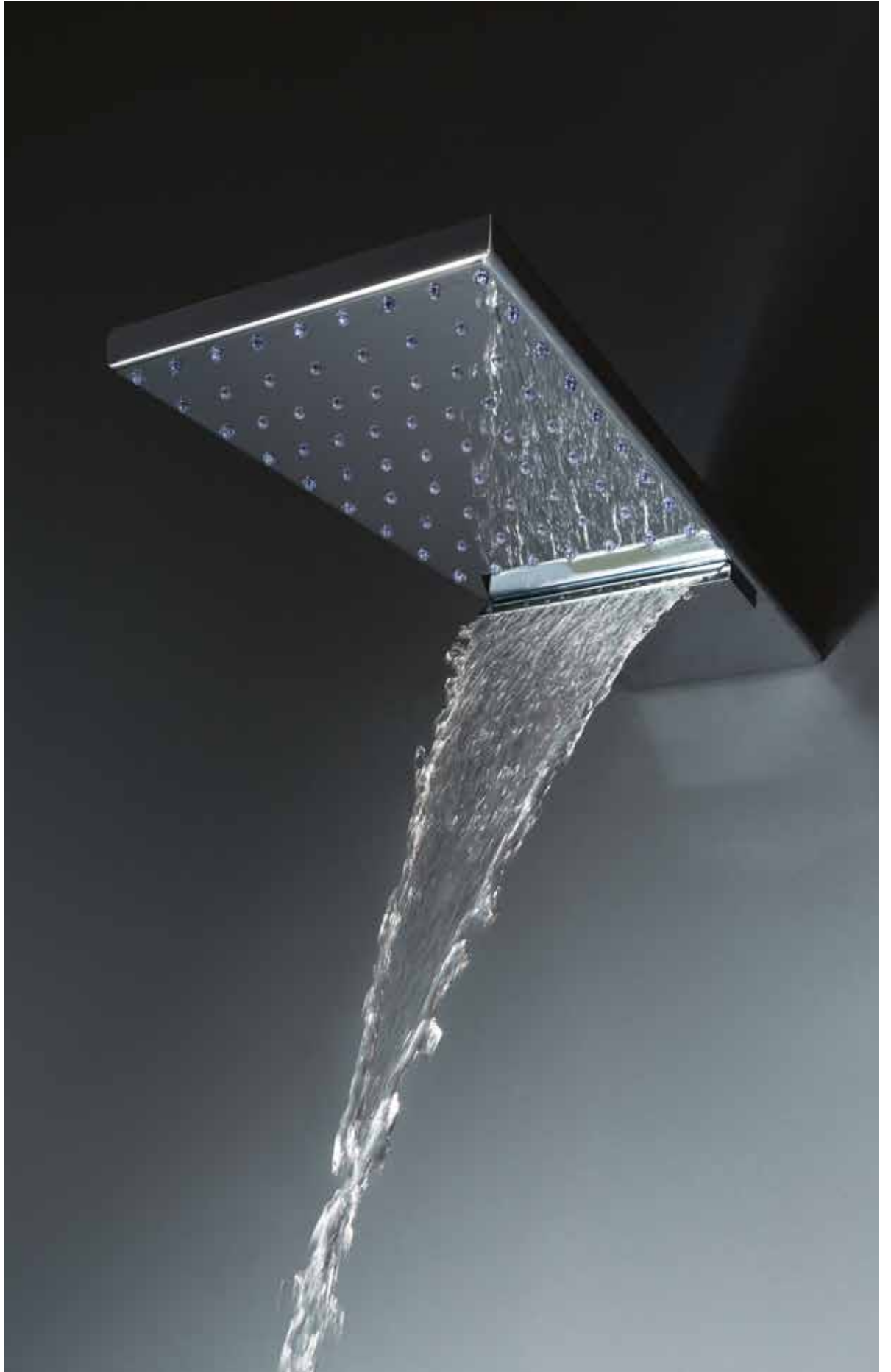



Comandi cromoterapia pagine 178-179

Chromotherapy controllers pages 178-179

Contrôleurs pour chromothérapie pages 178-179

Steuergeräte für Farbtherapie Seiten 178 -179



+







Unicità della maniglia, morbida leggerezza  
inserita nella scultorea soluzione architettonica  
dell'insieme.

Uniqueness of the handle: seductive sinuosity in a sculptural context.

Unicité de la poignée: sinuosité séduisante dans un contexte sculptural.

Die Einmaligkeit des Griffs, weiche Leichtigkeit eingefügt in die architektonische, skulpturische Gesamtlösung.





*SHARP studio formale, concept design*

modello depositato | registered pattern | modèle déposé | eingetragene Design

brevettato | patented | breveté | patentiert

pluvia

*design Luca Scacchetti*



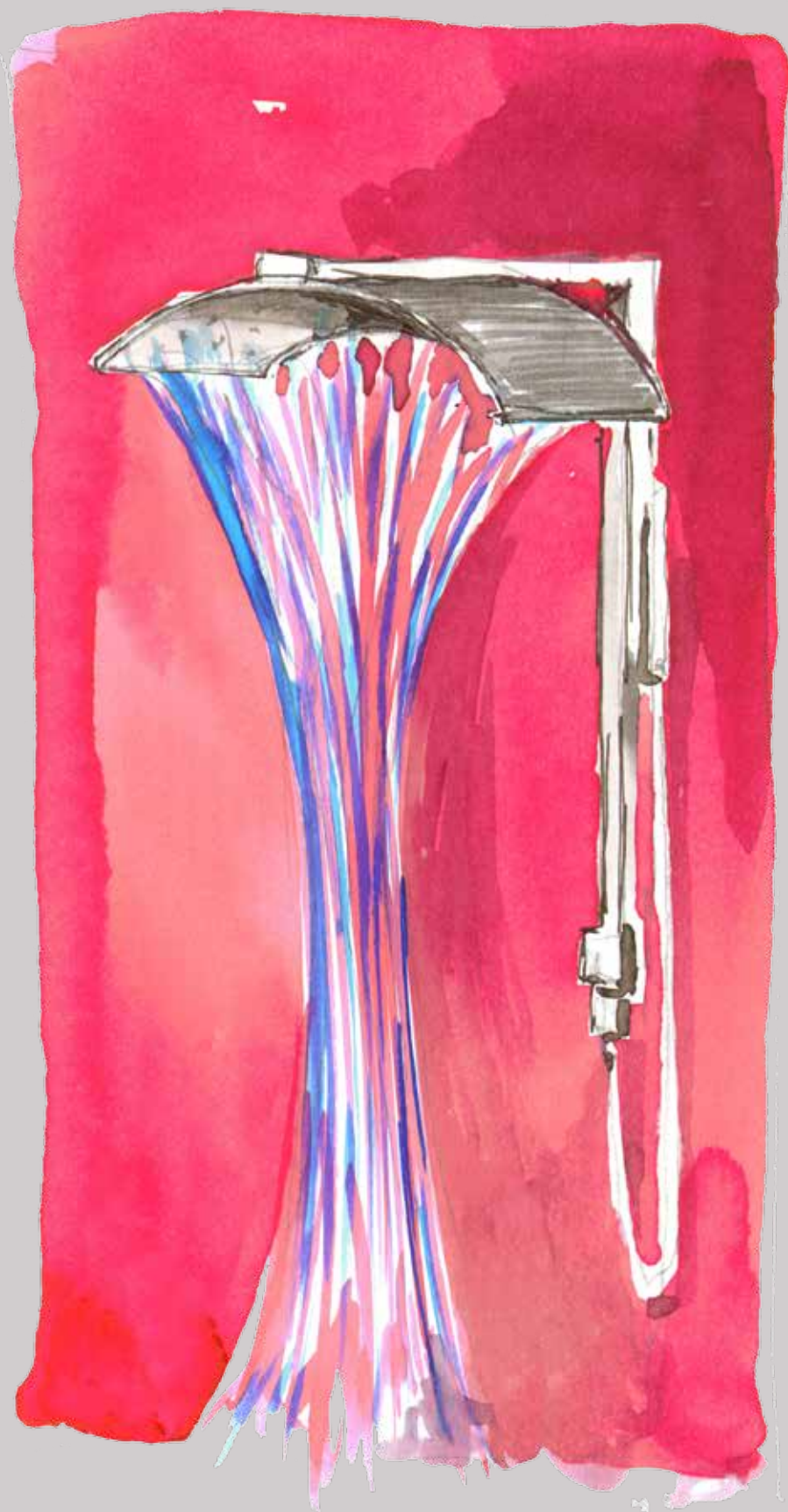



**CHRISTMUST**

2011

Dal CONCAVO CIELO  
la pioggia scrosciante si esibisce in gioiosi  
effetti speciali dai molteplici risvolti benefici.

The pouring rain coming from the concave sky creates a joyful outcome and a total wellness effect.

La pluie venante du ciel concave crée un jet joyeux et un effet de bien-être.

Der prasselnde Regen kommt vom hohlen Himmel mit freudigen, guttuenden Spezialeffekten.





Peculiarità della mensola, tenera leziosità nel maestoso contesto.

Peculiarity of the soap holder: mild preciousity in a majestic architecture.

Particularité du porte-savon: préciosité au sein d'une architecture majestueuse.

Die Eigenartigkeit des Seifen, zarte Geziertheit in einem majestätischen Kontext.





# SOFFIONE PLUVIA

PLUVIA SHOWER HEAD

POMME DE TÊTE PLUVIA

PLUVIA KOPFBRAUSE







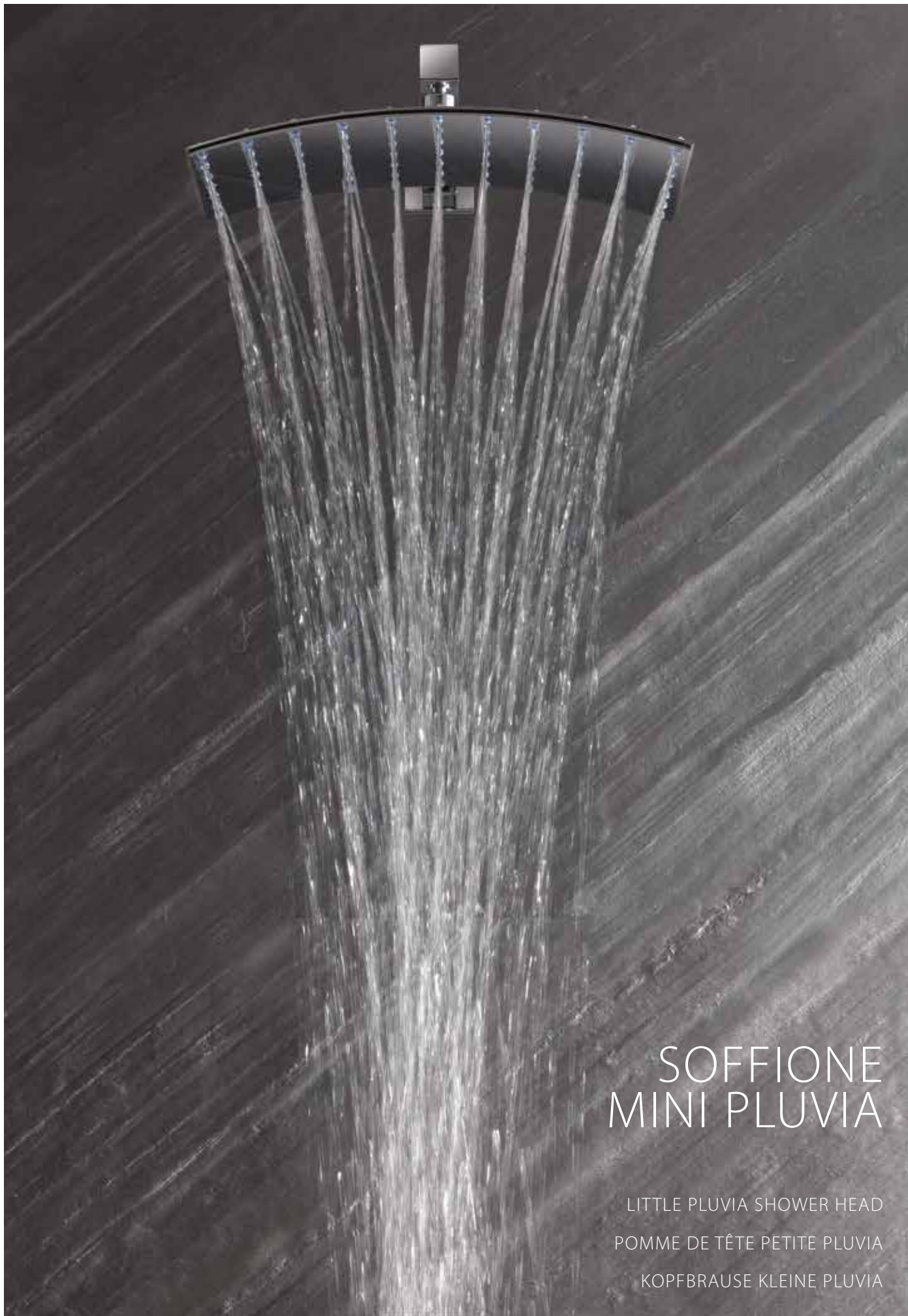

# SOFFIONE MINI PLUVIA

LITTLE PLUVIA SHOWER HEAD

POMME DE TÊTE PETITE PLUVIA

KOPFBRAUSE KLEINE PLUVIA

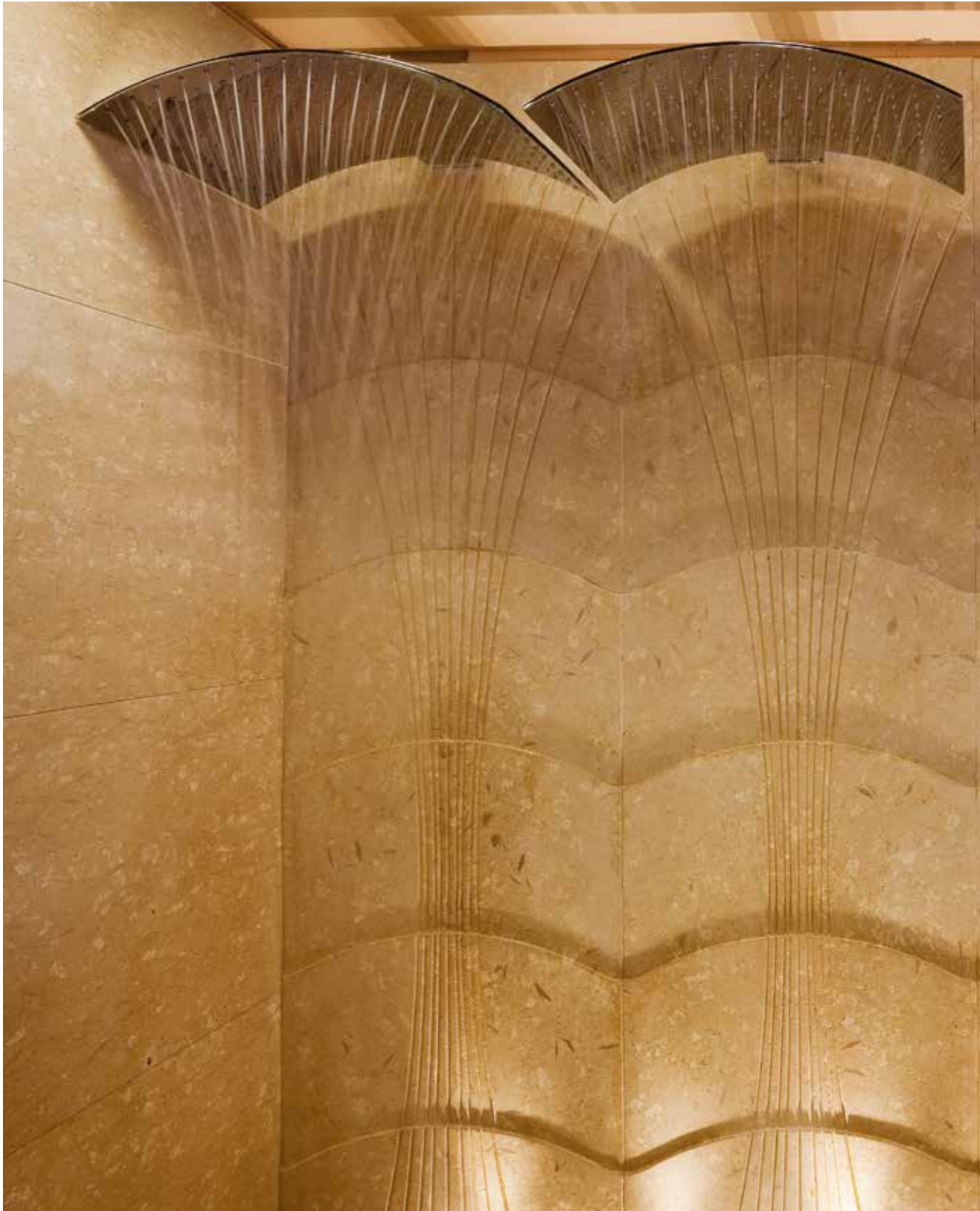





pluvia + mini pluvia



# arethusa

*design Luca Scacchetti*



















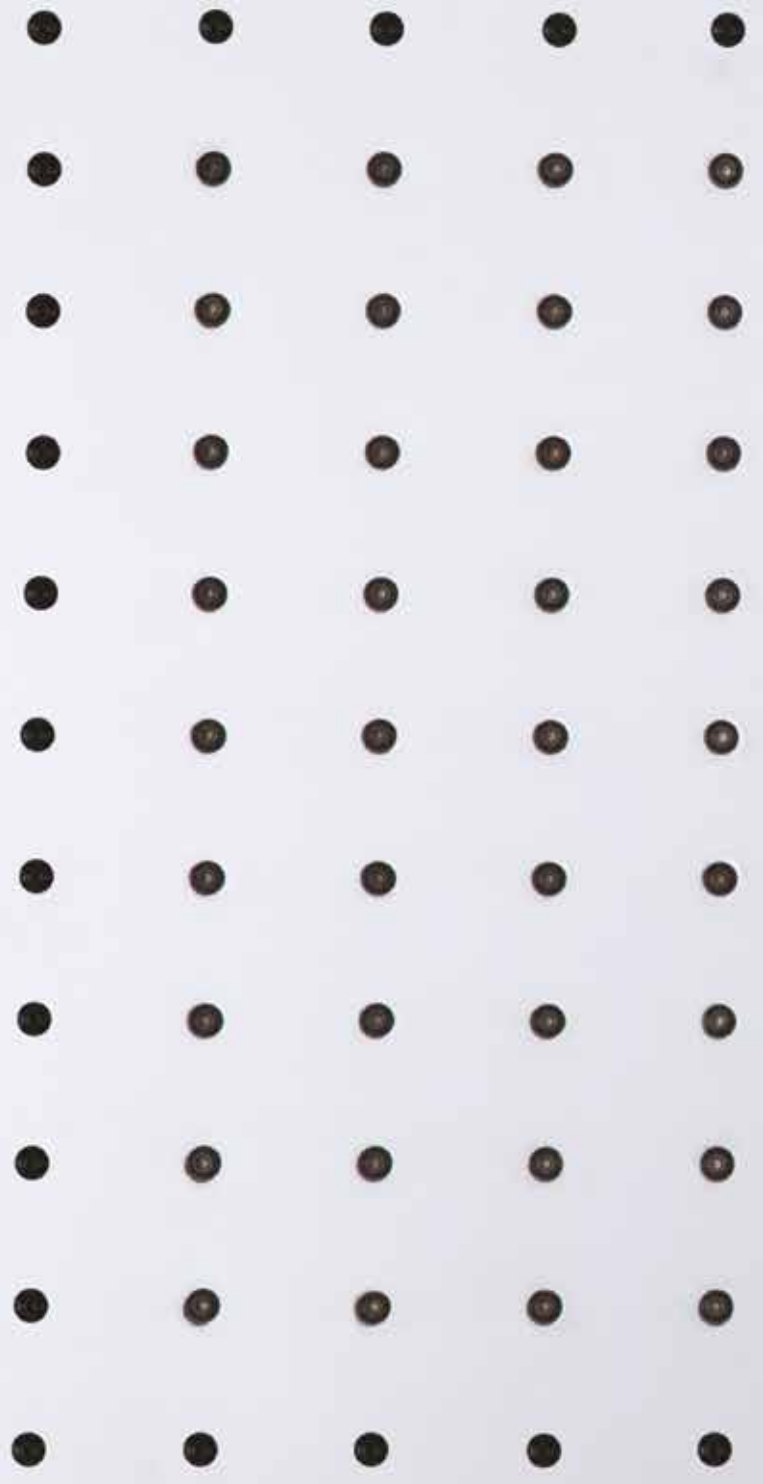





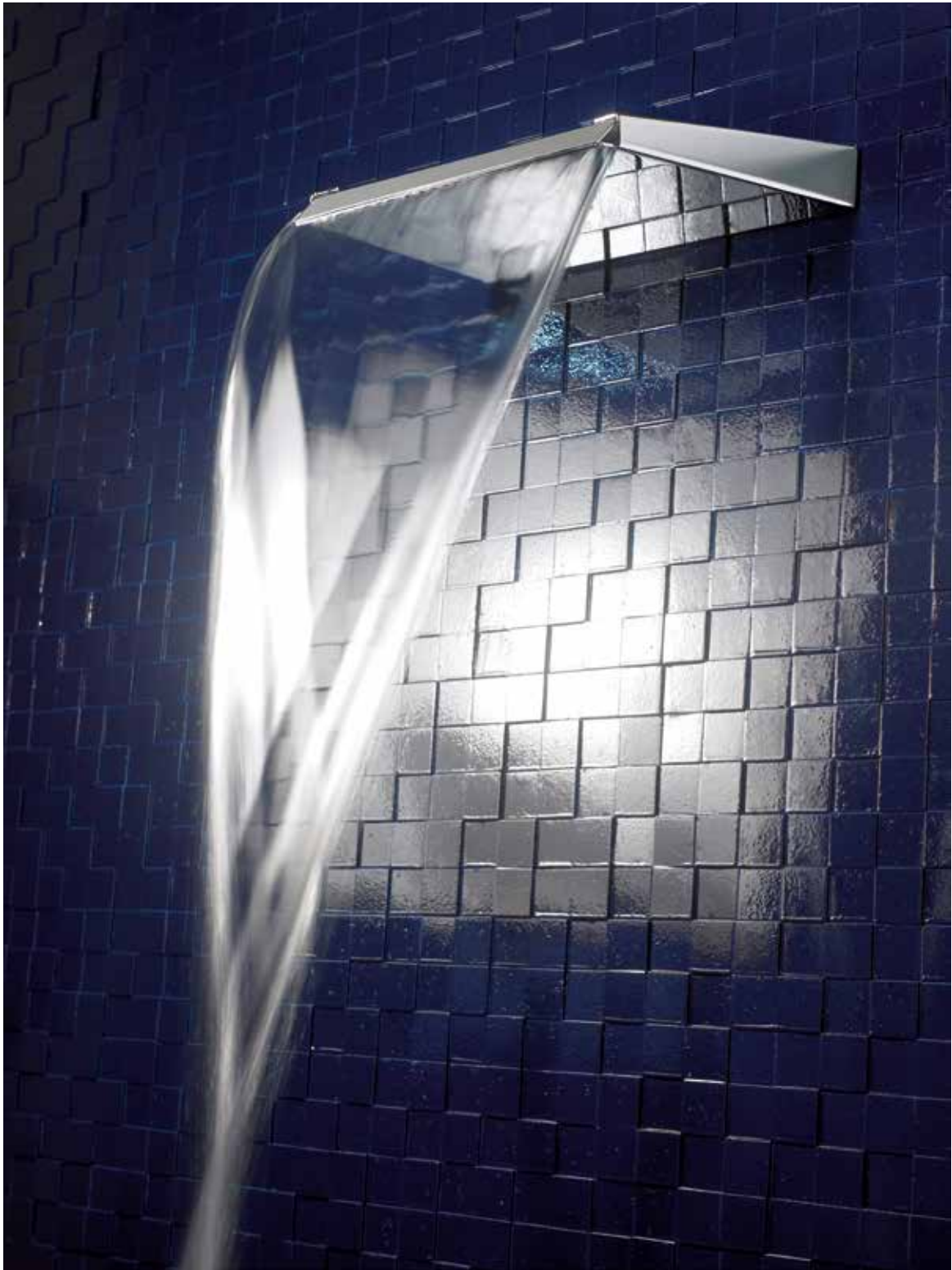

versione solo cascata

waterfall only  
cascade seule  
nur Wasserfall

jetto

*design Luca Scacchetti*





# Oggetto *icona* della ricerca e della qualità del DESIGN ITALIANO.

Jetto is an iconic object representing top class Italian design.

Objet icône de la recherche et de la qualité du design italien.

Ikone der Forschung und Qualität des italienischen Designs.

*Jetto fotografata da Pietro Carrieri.*

*Jetto photographed by Pietro Carrieri.*

*Jetto photographiée par Pietro Carrieri.*

*Jetto fotografiert bei Pietro Carrieri.*





La costante ricerca tecnologica e la grande attenzione ai particolari hanno permesso a tender rain® di ottenere una **scorrevolezza** senza eguali con un corpo in ottone massiccio che garantisce lunga **durata**.

Our constant research and attention to details allowed to obtain an incomparable **smoothness** with a **long-lasting** sliding element in solid brass.

Notre recherche constante et une grande attention aux détails ont permis d'obtenir une grande **fluidité** de mouvement avec un élément coulissant en laiton massif de longue **durée**.

Kontinuierliche technologische Forschung in Sachen tender rain® hat es ermöglicht, einen **Verstellbar** Körper in Massivmessing zu kreieren, der lange **Dauer** garantiert.







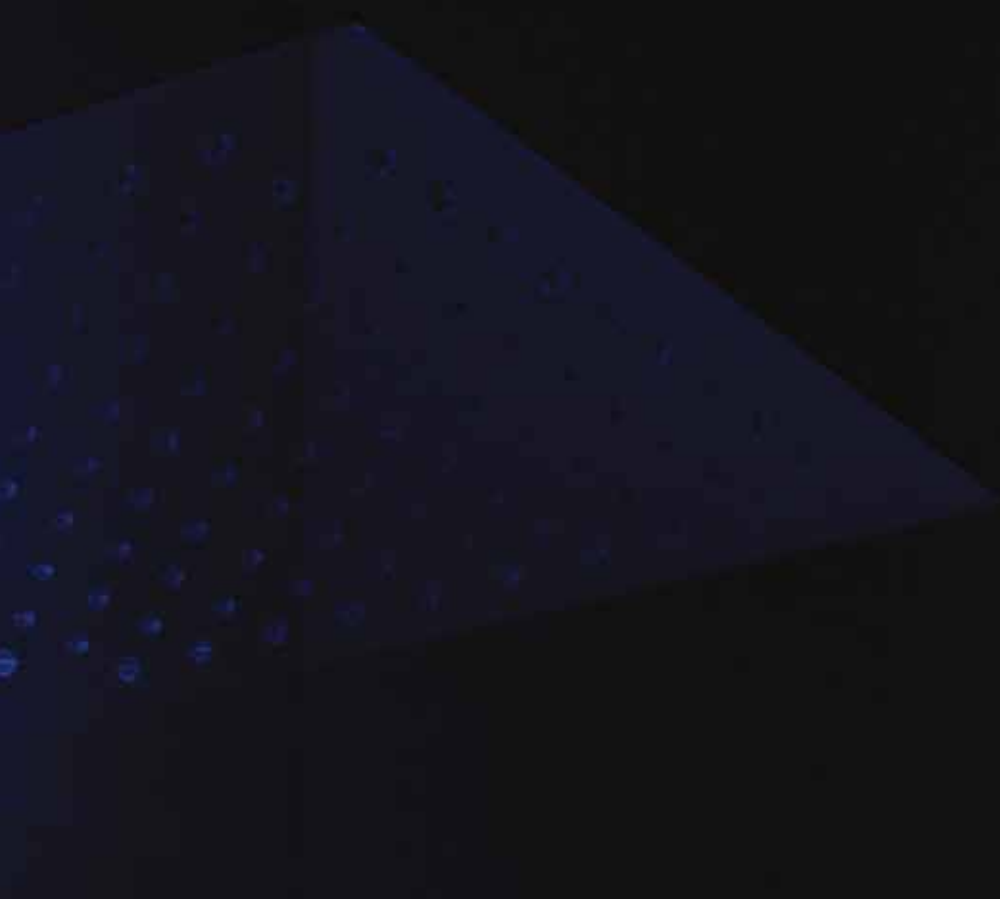

Comandi cromoterapia pagine 178-179

Chromotherapy controllers pages 178-179

Contrôleurs pour chromothérapie pages 178-179

Steuergeräte für Farbtherapie Seiten 178 -179







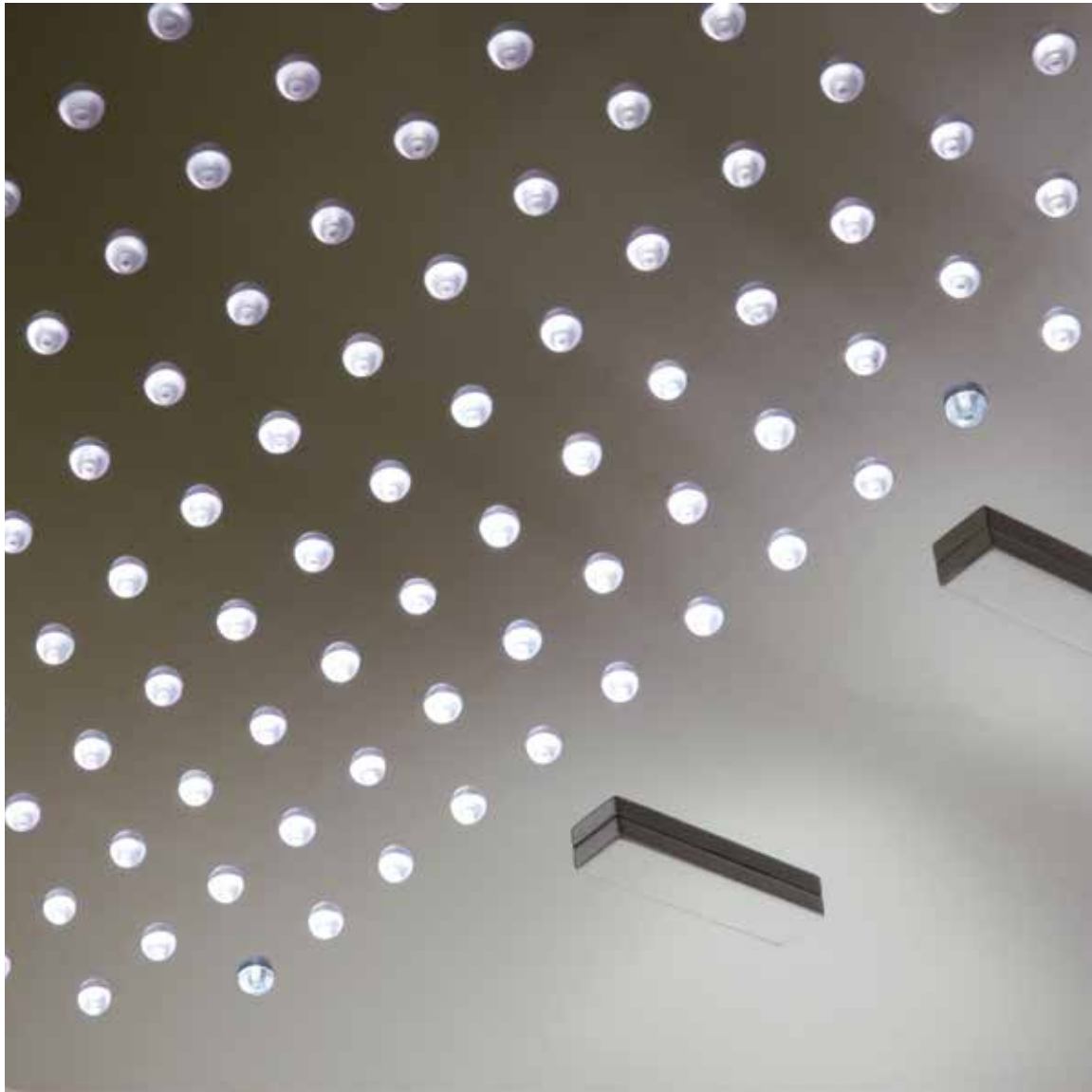

+



Comandi cromoterapia pagine 178-179

Chromotherapy controllers pages 178-179

Contrôleurs pour chromothérapie pages 178-179

Steuergeräte für Farbtherapie Seiten 178 -179



# menhir

*design Luca Scacchetti*





INCORRUTTIBILE,  
senza cedimenti, come una stele  
ritrovata assoluta nella sua forma con  
misteriosi dettagli e nicchie. Pilastro  
con reggi trave e mensole, superstite di  
un tempo dedicato al bagno o a tutte  
le *divinità acquatiche*.

Majestic and imposing pillar, with hidden recesses, mindful icon of ancient times, devoted to aquatic divinities.

Majestueuse et imposante colonne avec précieux détails caches. Icône qui évoque un temps éternel dédié aux divinités aquatiques.

Unbestechlich, ohne Nachzugeben, wie eine wiedergefundene Stele, absolut in der Form mit mysteriösen Details und Ausbuchtungen. Säule mit Leisten und Schrank, gerettet aus einer Zeit, die dem Baden und allen Wassergöttern gewidmet war.





finitura *“ottone ad invecchiamento naturale”*

Old natural brass finishing

Laiton vieillissement naturel

Messing mit Alterungsprozess



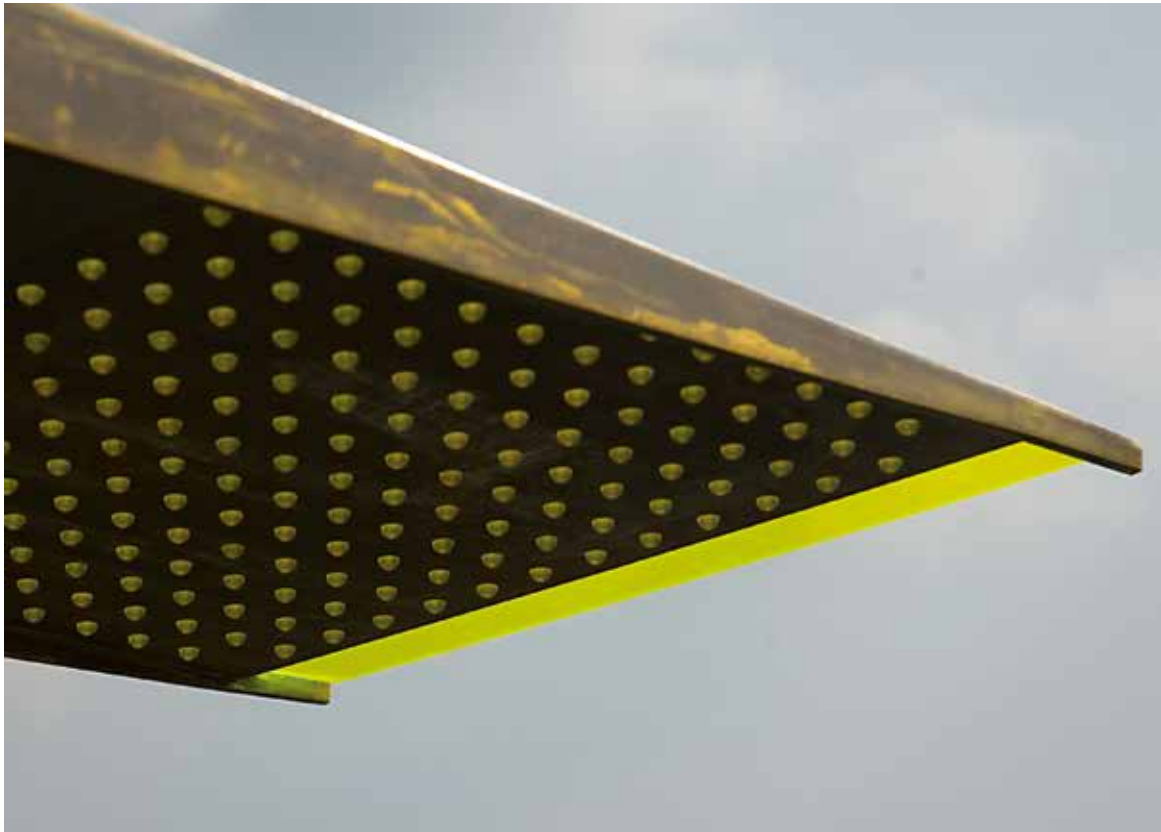

Un tocco di luce che rende Menhir ancora più unica ed esclusiva.

This touch of light makes Menhir even more unique.

Touche de lumière qui rend Menhir encore plus exclusive.

Eine Spur von Licht macht Menhir noch einzigartiger und exklusiver.



## doccetta estraibile

extractable handshower

douchette extractible

ausziehbare Handbrause









modello depositato | registered pattern | modèle déposé | eingetragene Design

brevettato | patented | breveté | patentiert

# calices

*design Luca Scacchetti*





Elemento multiforme, singolo



o plurimo, dalle linee morbide e sinuose.

Multiple or single multi shape element, with smooth and sinuous lines.

Élément multiforme individuel ou multiple, avec lignes fluides et sinueuses.

Multiform-Element, einzel oder mehrfach, mit weichen, kurvenreichen Linien.









## soffione singolo

single shower head  
pomme de tête individuelle  
einzel Kopfbrause

*"Ritratti di ospitalità Scaligera", Abitare il Tempo 2009, Verona*



## composizione multipla

multiple combination

combinaison multiple

mehrfach Zusammensetzung

*"La città dei segni sottili", Fuorisalone 2011, Fabbrica del Vapore, Milano*





## installazione a controsoffitto

false ceiling installation

installation au contre-plafond

blinde Decke Installation

pigreco

*design Luca Scacchetti*











Shower column with essential shape and meaningful geometric details.

Colonne de douche avec une forme essentielle et détails géométriques significatifs.

Säule mit einer essentiellen Form, die ihre geometrischen, einhaltsreichen Details unmittelbar demonstriert.

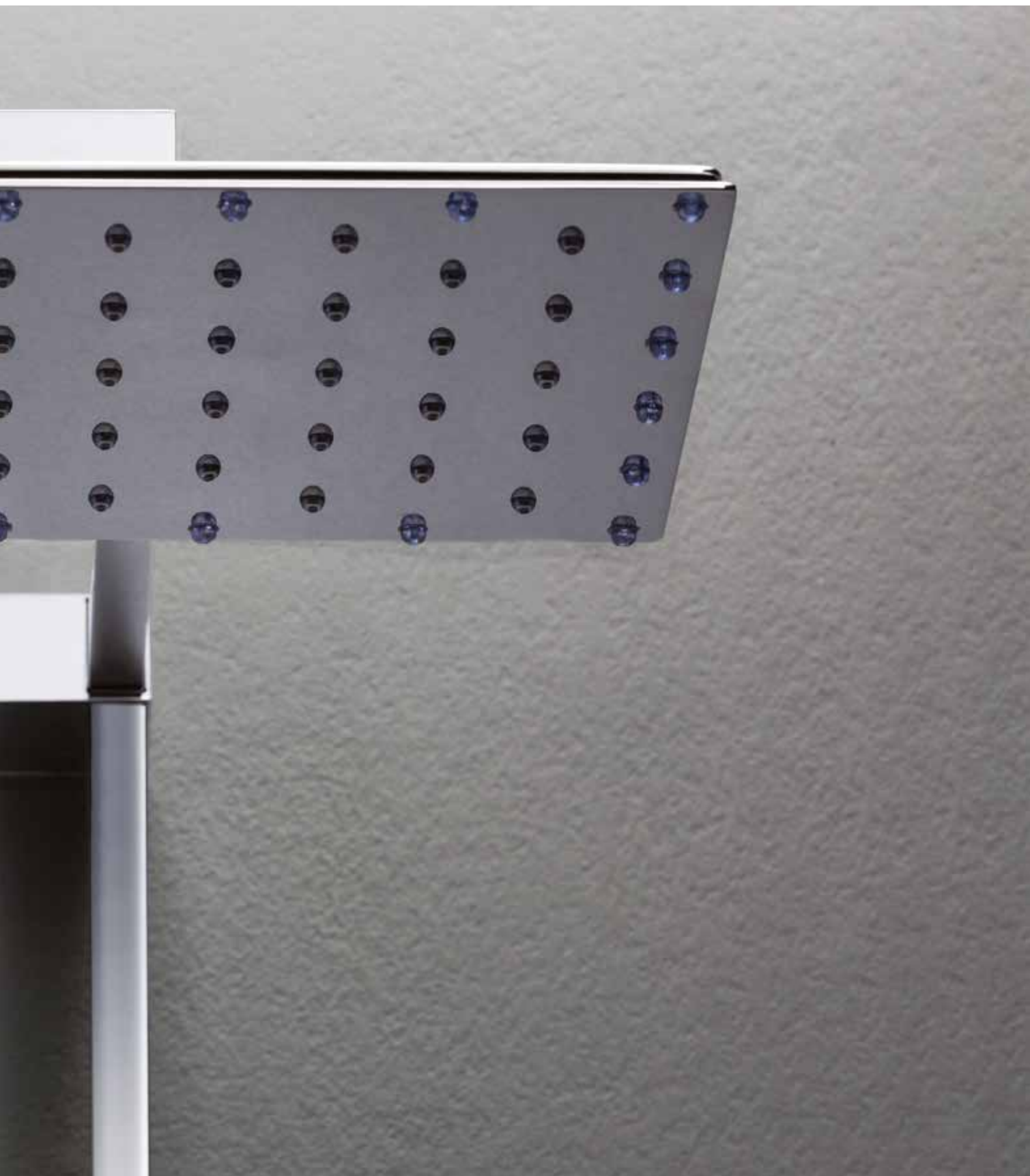

Colonna rigorosamente essenziale  
nella forma, esibisce con immediatezza  
i particolari GEOMETRICI del ricco contenuto.



La costante ricerca tecnologica e la grande attenzione ai particolari hanno permesso a tender rain® di ottenere una **scorrevolezza** senza eguali con un corpo in ottone massiccio che garantisce lunga **durata**.

Our constant research and attention to details allowed to obtain an incomparable **smoothness** with a **long-lasting** sliding element in solid brass.

Notre recherche constante et une grande attention aux détails ont permis d'obtenir une grande **fluidité** de mouvement avec un élément coulissant en laiton massif de longue **durée**.

Kontinuierliche technologische Forschung in Sachen tender rain® hat es ermöglicht, einen **Verstellbar** Körper in Massivmessing zu kreieren, der lange **Dauer** garantiert.













Rivoluzionario soffione doccia multifunzione,  
completo di braccio doccia e deviatore  
incorporato.

**CASCATA ORIENTABILE** che imbriglia gli spruzzi.

Revolutionary shower head with shower arm and diverter. **ADJUSTABLE WATERFALL** – no water sprinkling.

Pomme de tête révolutionnaire avec bras de douche et inverseur. **JET CASCADE RÉGLABLE** - sans éclaboussures.

Revolutionärer multifunktionaler Duschkopf, mit Brausearm und Umsteller. **ORIENTIERBARER WASSERSTRAHL**  
ohne Spritzen.

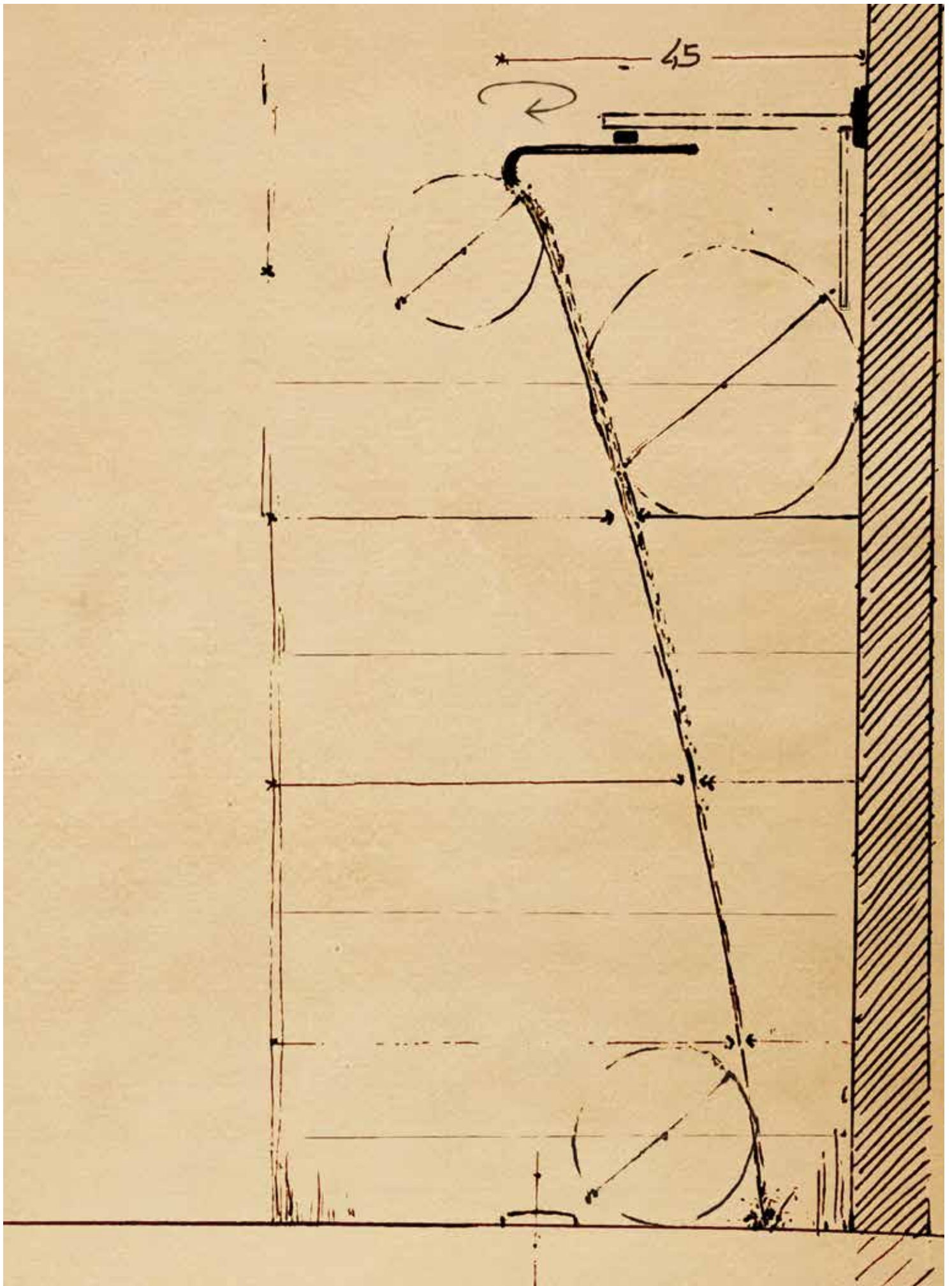















Braccio doccia in ottone con **cascata incorporata**,  
completo di deviatore semi-automatico.

Ideale per ristrutturazioni o nuovi impianti.

Shower arm in solid brass with **waterfall** and semi-automatic diverter. Perfect for either renovations or new installations.

Bras de douche en laiton massif avec **cascade** et inverseur semi-automatique. Parfait pour rénovations ou nouvelles installations.

Brausearm in Messing mit **Wasserfall** und semi-automatischem Umsteller. Ideal für Renovierungen oder Neuinstallationen.







Braccio doccia in ottone **con doccetta**, completo di deviatore semi-automatico azionabile tramite il flessibile.

Ideale per ristrutturazioni o nuovi impianti.



Shower arm in solid brass **with handshower** and semi-automatic diverter, activated through the flexible hose. Perfect for either renovations or new installations.

Bras de douche en laiton massif **avec douchette** et inverseur semi-automatique, activé par le flexible. Parfait pour rénovations ou nouvelles installations.

Brausearm in Messing **mit Handbrause** und semi-automatischem Umsteller, der mittels des Schlauchs aktiviert wird. Ideal für Renovierungen oder Neuinstallationen.



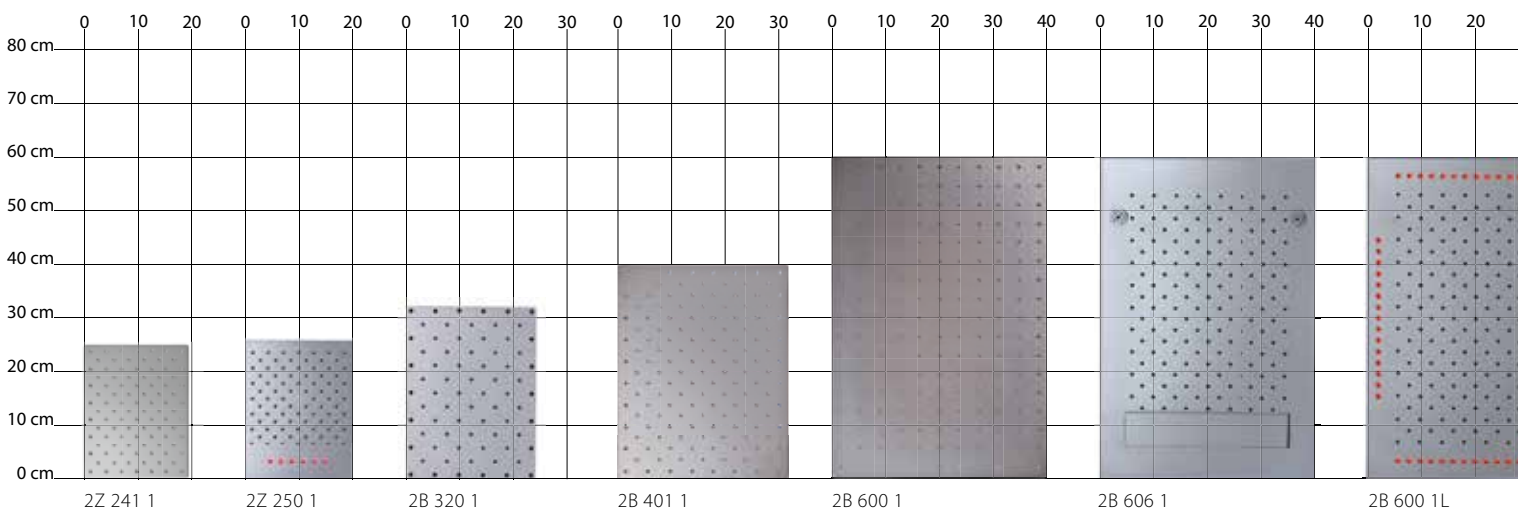
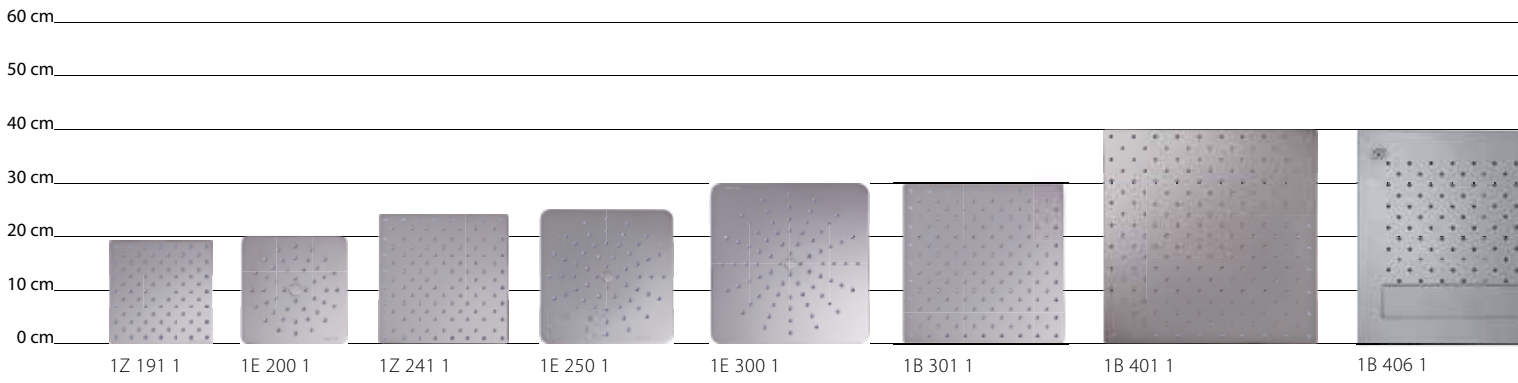
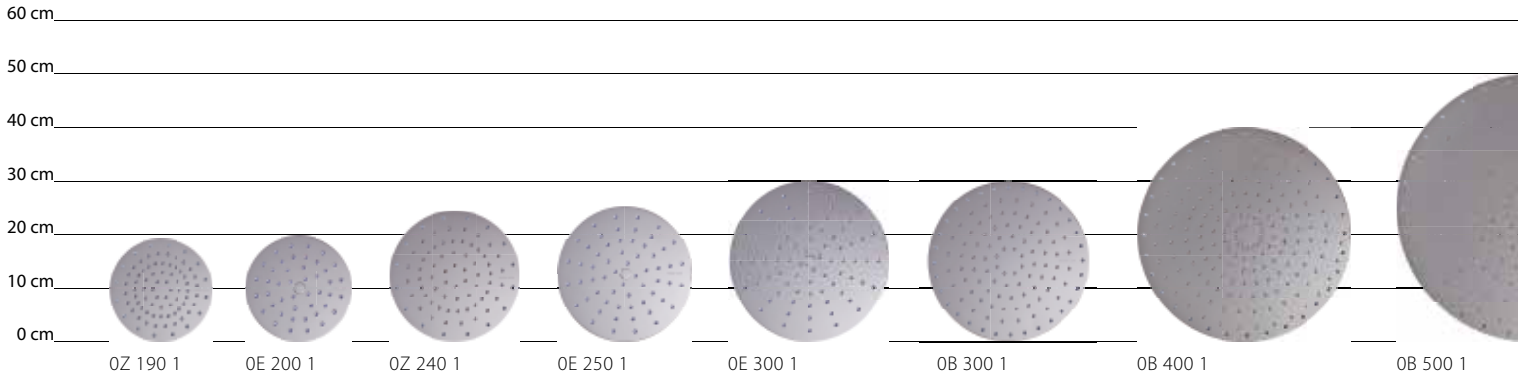



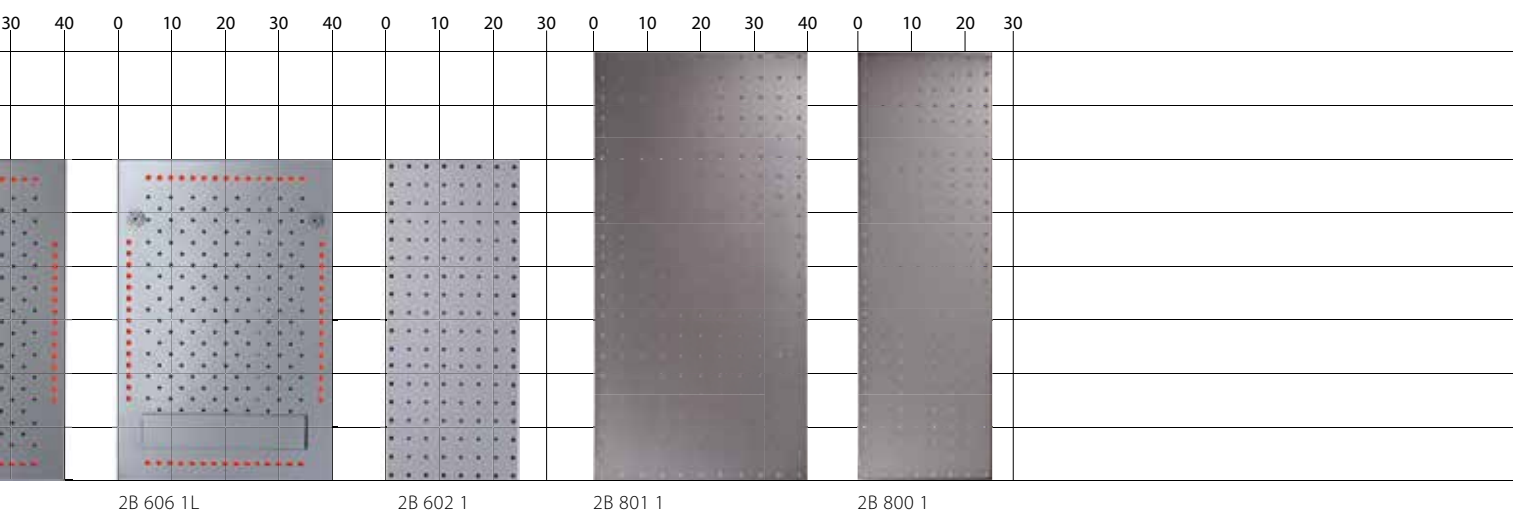
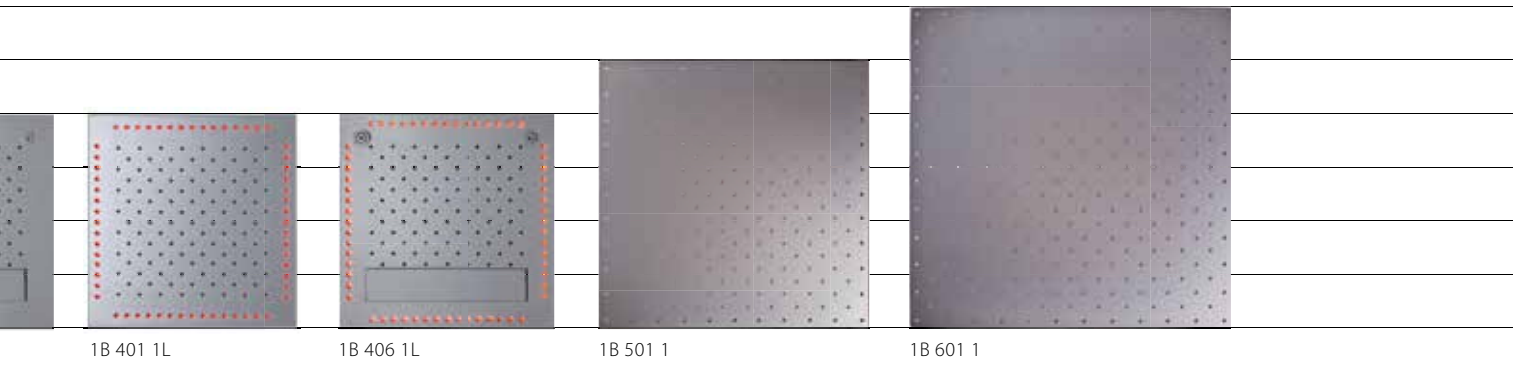

modello depositato | registered pattern | modèle déposé | eingetragene Design

brevettato | patented | breveté | patentiert

big rain

*TR Studio Design*

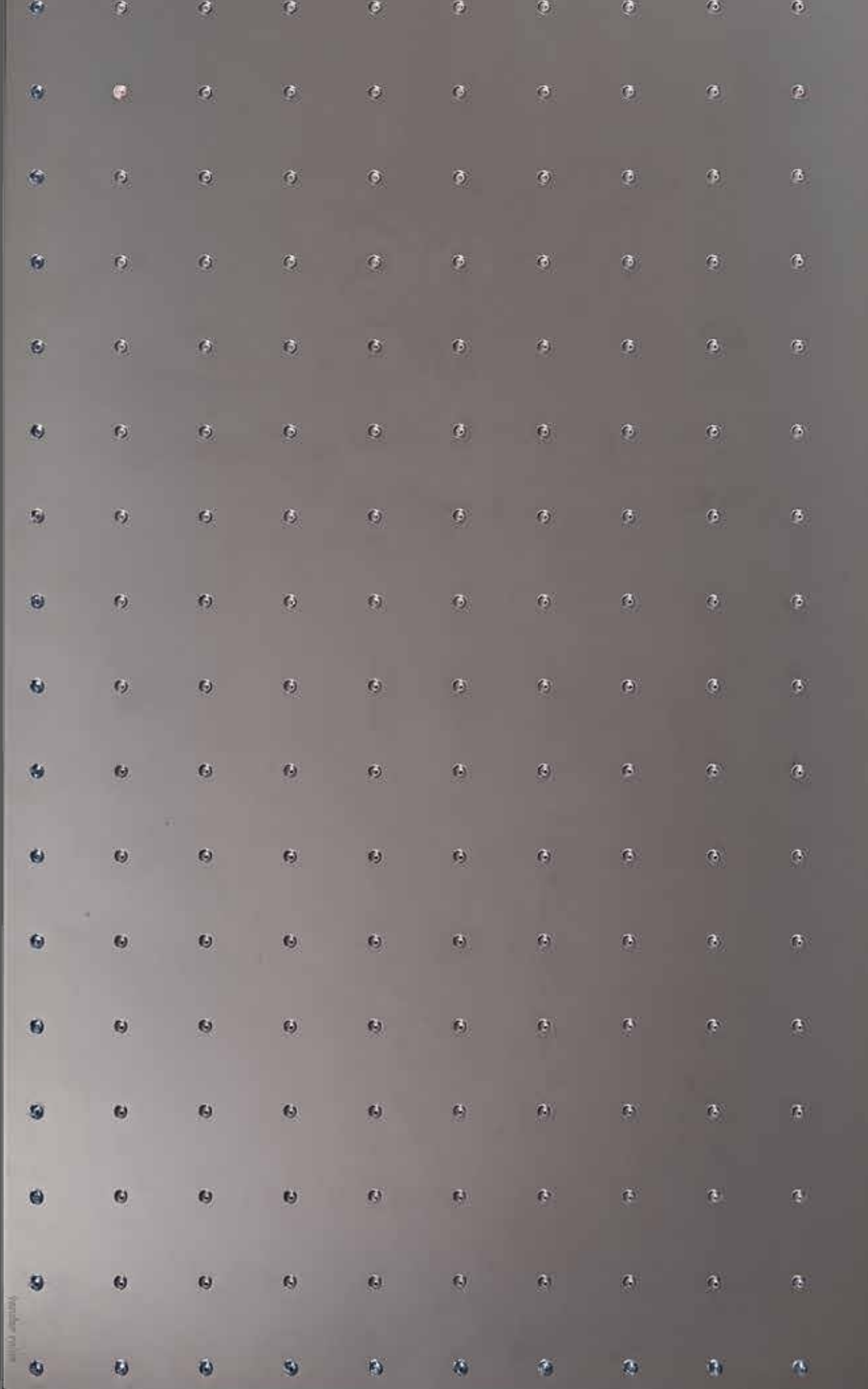

Vertical text on the left side of the grid.



Impressive dimensions which arouse astonishment and create new habits and total comfort.

Dimensions imposantes qui suscitent étonnement et créent de nouvelles habitudes et un confort total.

Beeindruckende Dimensionen, die überraschen und sowohl Gewohnheiten als auch Badezonen zu einem totalen Komfort umgestalten.



DIMENSIONI IMPONENTI  
che generano stupore e modificano  
abitudini e spazi per un confort totale.

# La “sproporzione” amica dell’ambiente.

Eco-friendly dimensions.

Dimensions imposantes respectueuses de l’environnement.

Umweltfreundliche Größe.











## a controsoffitto

false ceiling installation

encastrement au contre-plafond

blinde Decke Montage



## con tiranti

with fasten device  
avec cables de fixation  
mit Befestigungssystem



## con braccio

with shower arm  
avec bras de douche  
mit Brausearm

brevettato | patented | breveté | patentiert

# soffioni multifunzione

multifunction shower heads | pommes de tête multifonction | multifunktions Kopfbrausen

*TR Studio Design*



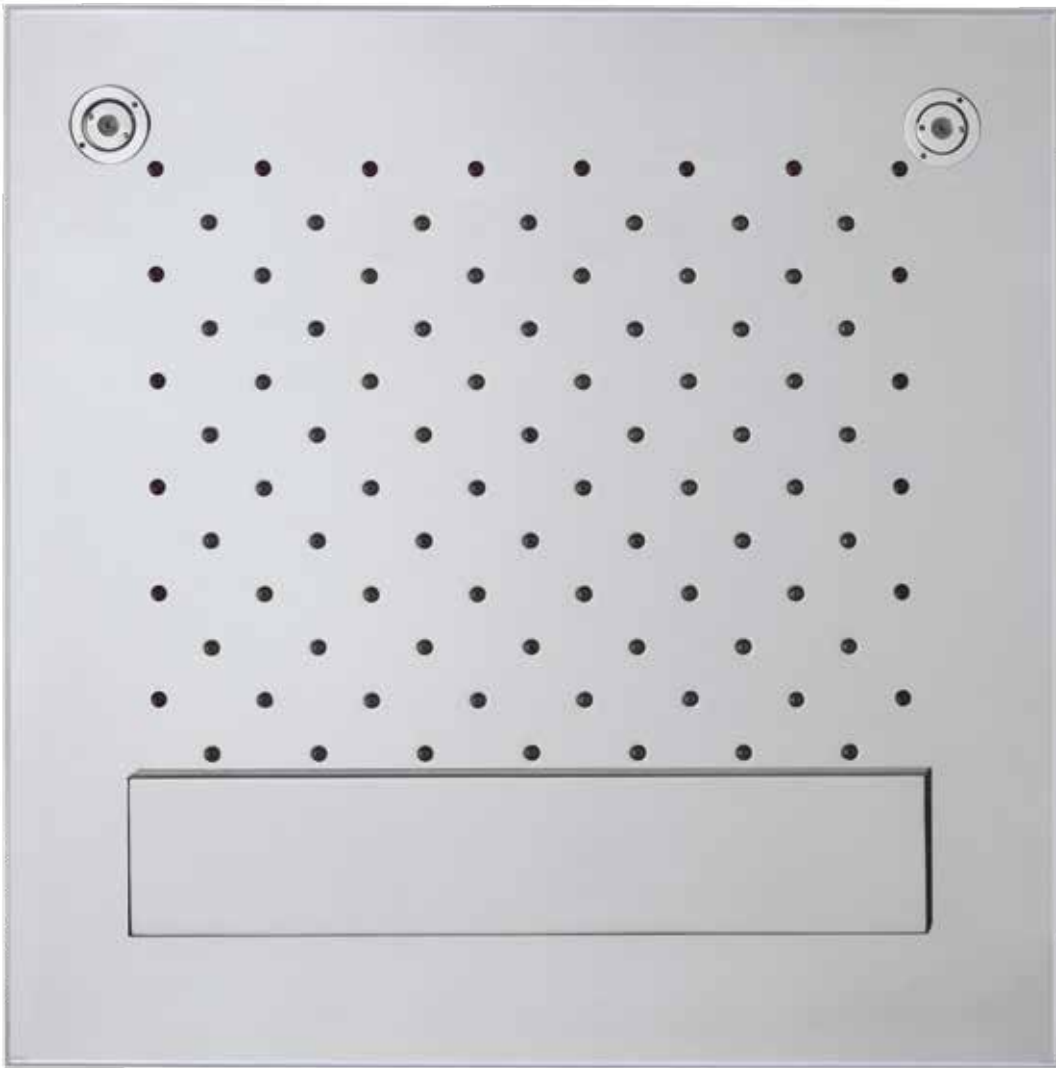

## big rain multifunzione **solo** a controsoffitto

multifunction shower head – false ceiling installation **only**

pomme de tête multifonction – **seulement** pour encastrément au contre-plafond

multifunktions Kopfbrause – **nur** Blinde Decke Montage







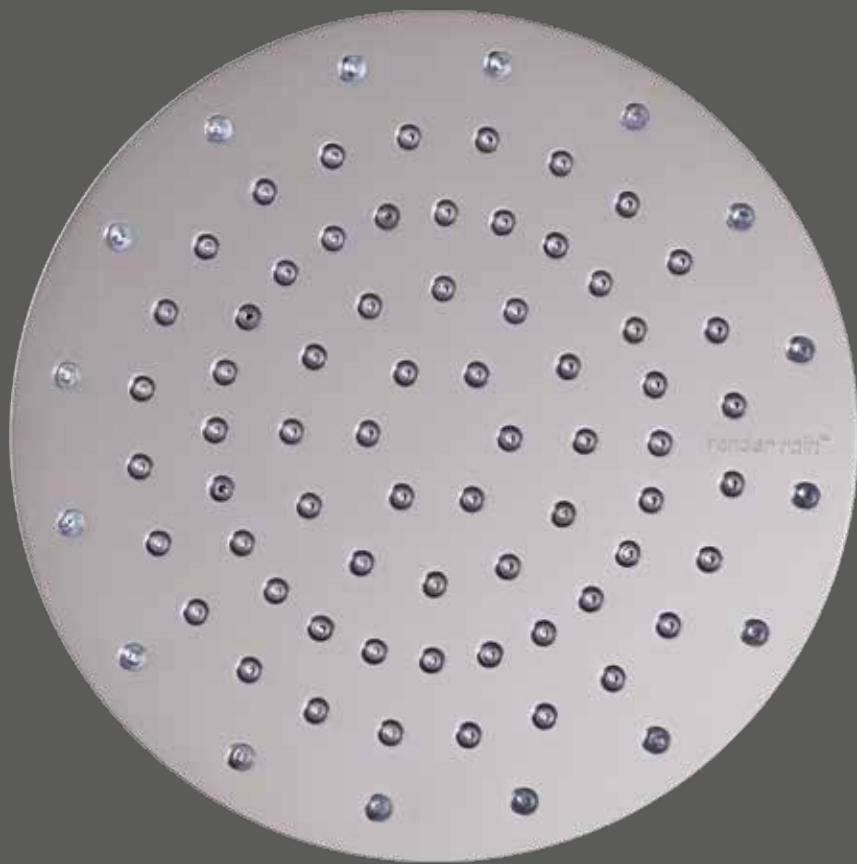

L'innovazione tecnologica

## **NEL RISPETTO DELLA NATURA**

attua l'ecologia sociale, mediatrice tra necessità e risorse.

Technological innovation, **RESPECT FOR NATURE**, social ecology. The perfect compromise between resources and needs.

Innovation technologique, **RESPECT DE LA NATURE**, écologie sociale. Le compromis parfait entre les ressources et les besoins.

Technologische Innovation mit **RESPEKT FÜR DIE NATUR**, die soziale Ökologie verwirklicht und zwischen Bedarf und Ressourcen vermittelt.



**I CONSUMI PIÙ BASSI DELLA CATEGORIA!**

THE LOWEST CONSUMPTION OF ITS CATEGORY!

LA CONSOMMATION LA PLUS BASSE DE SA CATÉGORIE!

DER NIEDRIGSTE VERBRAUCH IN DIESER KATEGORIE!

# sintesi di qualità ed ecologia

blending of quality and ecology

combinaison de qualité et écologie

Synthese aus Qualität und Ökologie









## a controsoffitto con cascata e nebulizzazione

false ceiling installation with waterfall and nebulization

encastrement au contre-plafond avec cascade et nébulisation

blinde Decke Montage mit Wasserfall und Nebulisierung





## con tiranti

with fasten device  
avec cables de fixation  
mit Befestigungssystem



## con braccio

with shower arm  
avec bras de douche  
mit Brausearm



## Centralina per cromoterapia con pulsantiera di comando a muro touch screen LCD

Chromotherapy controller with wall mounted LCD touch screen button panel

Contrôle pour chromothérapie avec panneau de contrôle tactile LCD

Steuergerät für Farbtherapie mit LCD Touchscreen Schalttafel

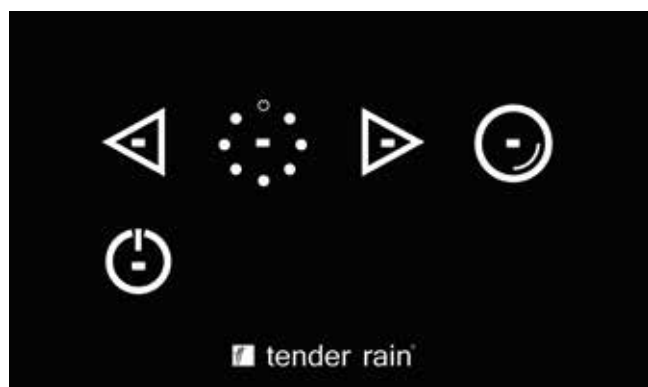

## Centralina per cromoterapia con pulsantiera di comando a muro touch capacitiva

Chromotherapy controller with wall mounted capacitive touch button panel

Contrôle pour chromothérapie avec panneau de contrôle capacitif

Steuergerät für Farbtherapie mit kapazitiver Technologie

disponibile anche per:

also available for:

disponible aussi pour:

verfügbar auch für:

pagina:

page | page | Seite



## Centralina Wi-Fi multicolore per cromoterapia con telecomando

Multicolor chromotherapy Wi-Fi controller with remote control

Contrôleur multicolore Wi-Fi pour chromothérapie avec télécommande

WLAN-Steuergerät mit Fernbedienung für Multicolor-Farbtherapie



## Supreme System



## Plus System



Emisfero 36



Sharp 46



Jetto 90

modello depositato | registered pattern | modèle déposé | eingetragene Design

brevettato | patented | breveté | patentiert



essentia

*TR Studio Design*

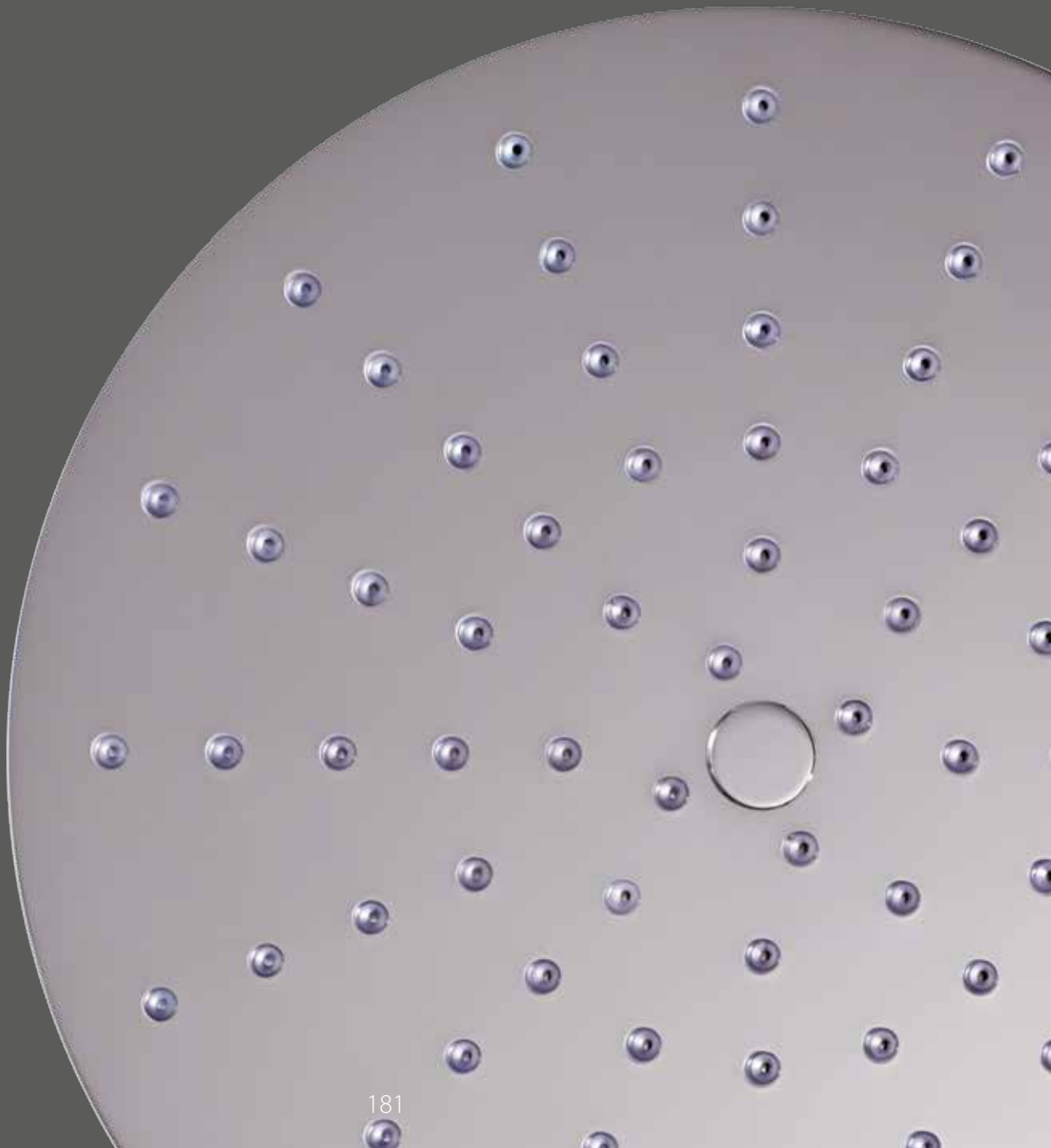

La rappresentazione concettuale,  
tradotta in OGGETTI DI PRIMARIA ESIGENZA,  
non si concede *leziosità*.

Minimalist representation without pretentiousness.

Représentation minimaliste sans prétention.

Konzeptuelle Repräsentation, übersetzten geräte der ersten Klasse, Geziertheit ist nicht erlaubt.

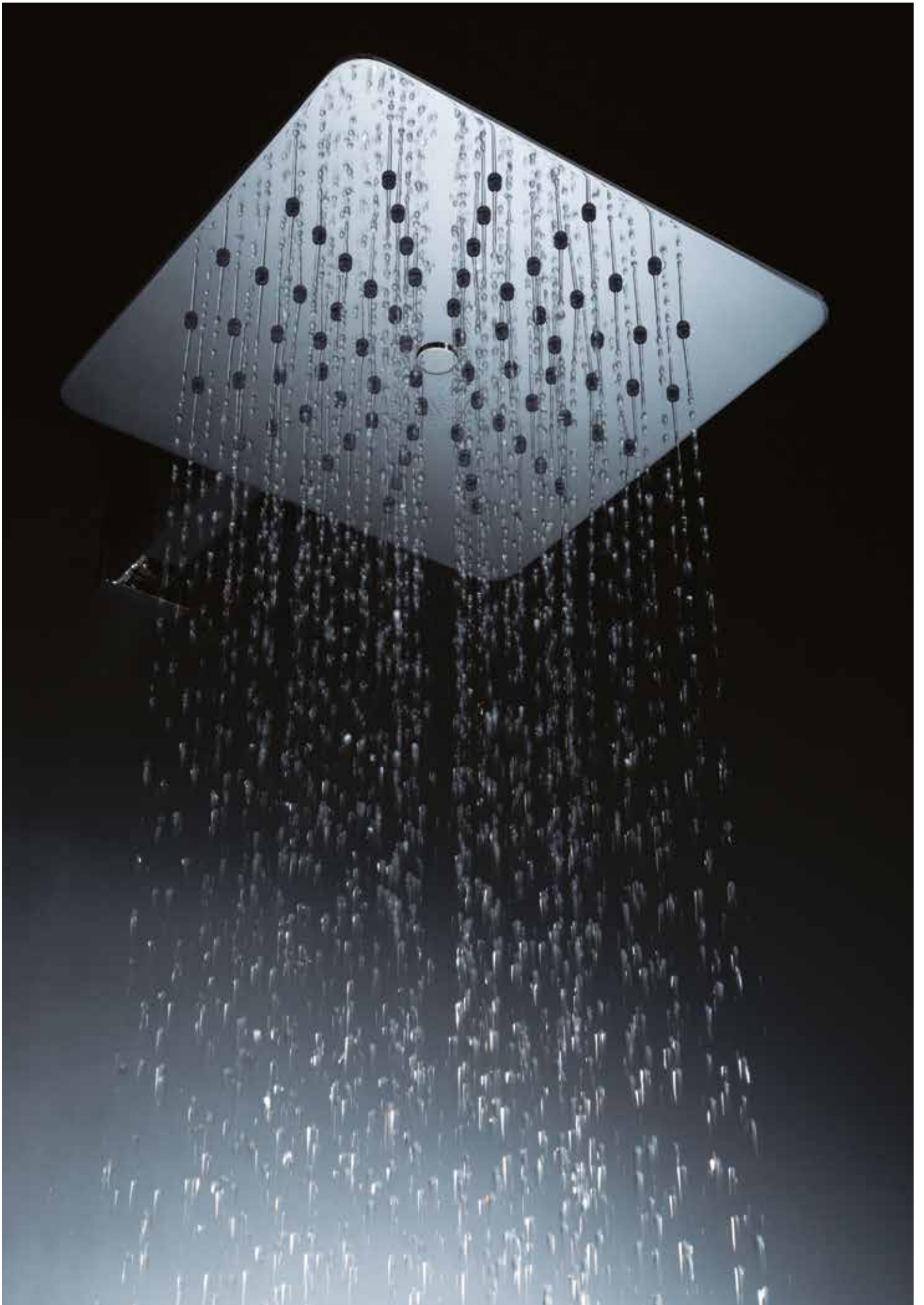

# l'emblema del lusso

emblem of luxury

emblème du luxe

das Emblem von Luxus







# colonne rettangolari

rectangular section rising rails | colonnes rectangulaires | Rechteckschnitt Duschpaneele

*TR Studio Design*



R4



R4

Colonna doccia a muro per ristrutturazioni  
senza interventi strutturali.



Wall mounted rising rail for bathroom renovations without structural changes.

Colonne de douche murale pour rénovations sans nécessiter d'intervention structurelle.

Duschpaneel für Wandmontage für Renovierung ohne strukturelle Veränderung.



customization  
on demand



su misura  
a richiesta

## colonna da muro

wall mounted rising rail

colonne de douche murale

Wandmontage

R2



## colonna da terra

self standing rising rail

colonne de douche sur pieds

Standmontage

R1

# colonne cilindriche

round section rising rails | colonnes cylindriques | runde Schnitt Duschpaneele

*TR Studio Design*





C0

CO





C1





ottone

brass  
laiton  
Messing



acciaio inox

stainless steel  
acier inoxydable  
Edelstahl

# colonne echo

echo rising rails | colonnes echo | Duschpaneele echo

*TR Studio Design*

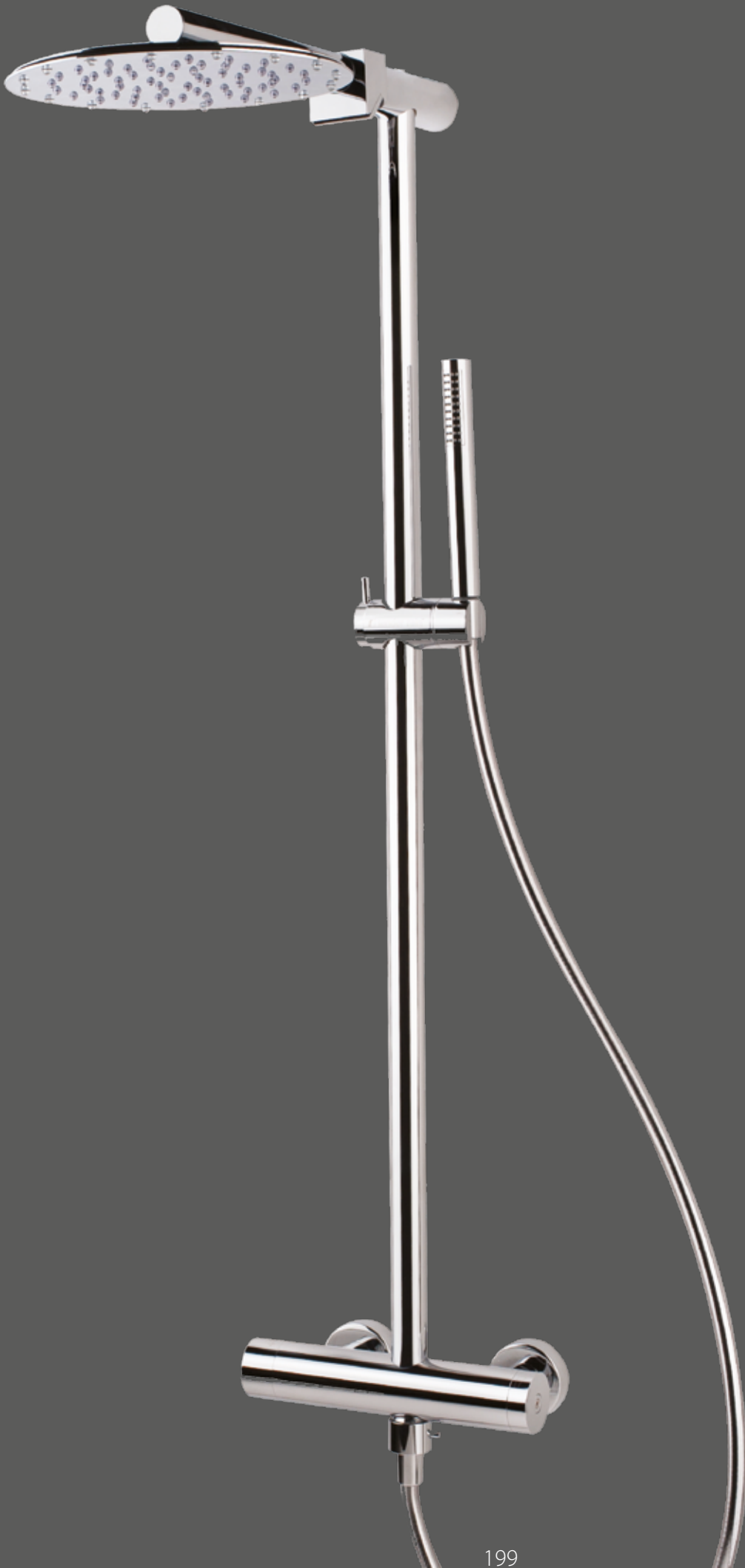

echo cascata







echo cascata



# termostatico a corpo freddo con lavorazione a diamante naturale

cold body diamond cut thermostatic mixer

mitigeur thermostatique à corps froid découpé avec diamant naturel

thermostatische Mischer mit Verbrühungsschutz, Verarbeitung mit natürlichem Diamant



customization  
on demand



su misura  
a richiesta



## termostatico a corpo freddo

cold body thermostatic mixer

mitigeur thermostatique à corps froid

thermostatische Mischer mit Verbrühungsschutz



echo minimale





echo classica





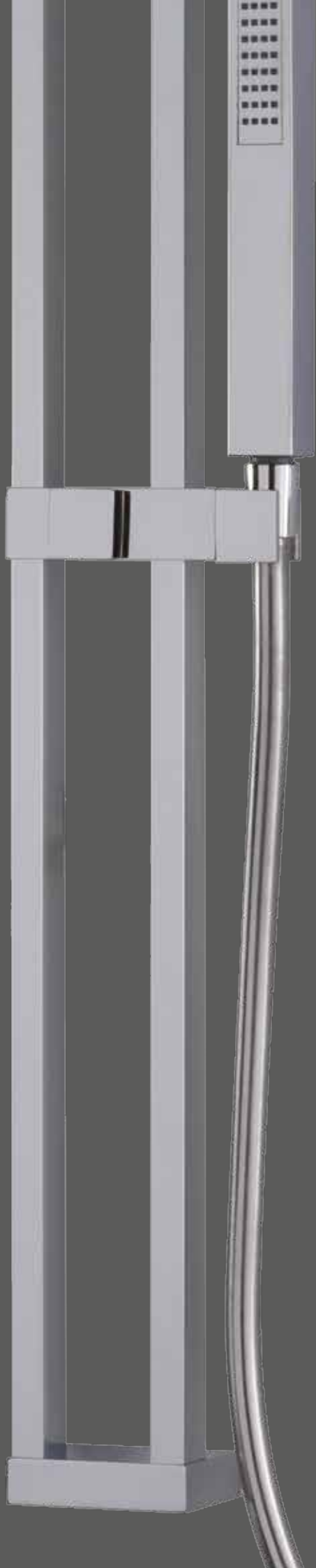

CON SUPPORTI  
REGOLABILI E ATTACCO  
ACQUA ADATTABILE  
INFERIORE/SUPERIORE

WITH ADJUSTABLE WALL MOUNTS AND  
ADAPTABLE WATER PLUG FOR LOW OR  
HIGH CONNECTION

SUPPORTS DE FIXATION RÉGLABLES  
ET RACCORDEMENT AU RÉSEAU D'EAU  
ADAPTABLE INFÉRIEUR/SUPÉRIEUR

EINSTELLBAR HALTERING UND  
EINSTELLBAR WASSERANSCHLUSS FÜR  
TIEF ODER HOCH VERBINDUNG



con miscelatore esterno

with external mixer  
avec mitigeur apparent  
mit externem Einhebelmischer



con miscelatore esterno

with external mixer  
avec mitigeur apparent  
mit externem Einhebelmischer



con miscelatore a incasso

with built-in mixer  
avec mitigeur à encastrer  
mit Einhebelmischer Mauereinbau



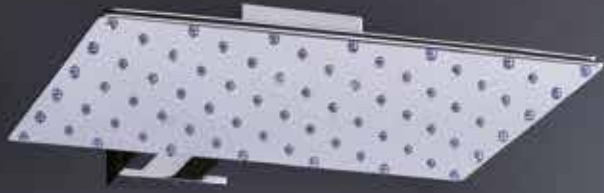

# gruppo vasca da terra

freestanding bathtub faucet | mitigeur sur pieds | Wannenmischer bodenstehend

*TR Studio Design*

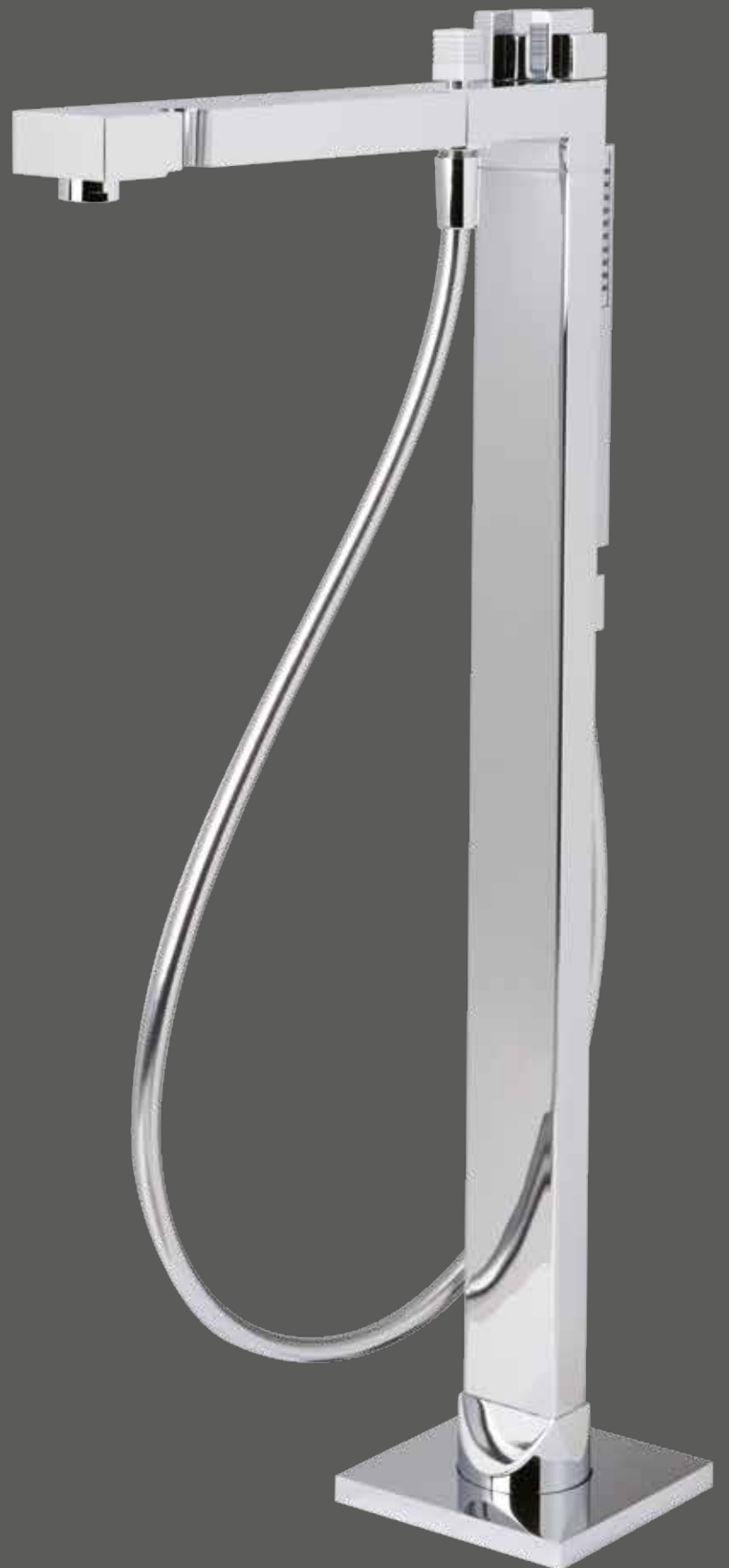







gruppo vasca in ottone massiccio  
dotato di **bocca orientabile**  
con portadoccetta aggiuntivo incorporato.

bathtub faucet in solid brass with **adjustable spout** and additional included shower holder.

bain douche en laiton massif avec **bec orientable** et support de douchette supplémentaire intégré.

Wannenmischer aus massiven Messing mit **einstellbarem Auslauf** und einsetzendem zusätzlichem Brausehalter.

# bocca soffitto

ceiling spout | bec de plafond | Deckenauslauf

*TR Studio Design*

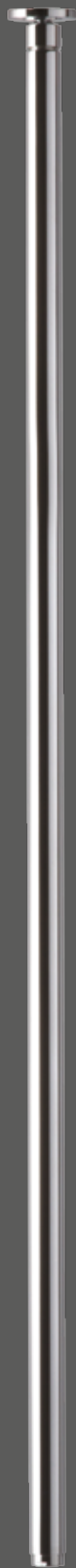

orientabile

adjustable

orientable

einstellbar









modello depositato | registered pattern | modèle déposé | eingetragene Design

brevettato | patented | breveté | patentiert



emisfero

*design Luca Scacchetti*





La modernità si tinge di suggestive sfumature di colore o di forme del passato in omaggio a un pubblico appassionato di tutto ciò che lo ricorda.

For all people fascinated by old time splendor, a marriage between modern design and warm colour shades.

Pour ceux qui sont fascinés par le charme du passé, un mariage entre le design moderne et les teintes chaudes.

Modernität mit einem suggestiven Touch von Farben aus der Vergangenheit, als Hommage an alle Liebhaber der Geschichte.



modello depositato | registered pattern | modèle déposé | eingetragene Design

brevettato | patented | breveté | patentiert



calices

*design Luca Scacchetti*





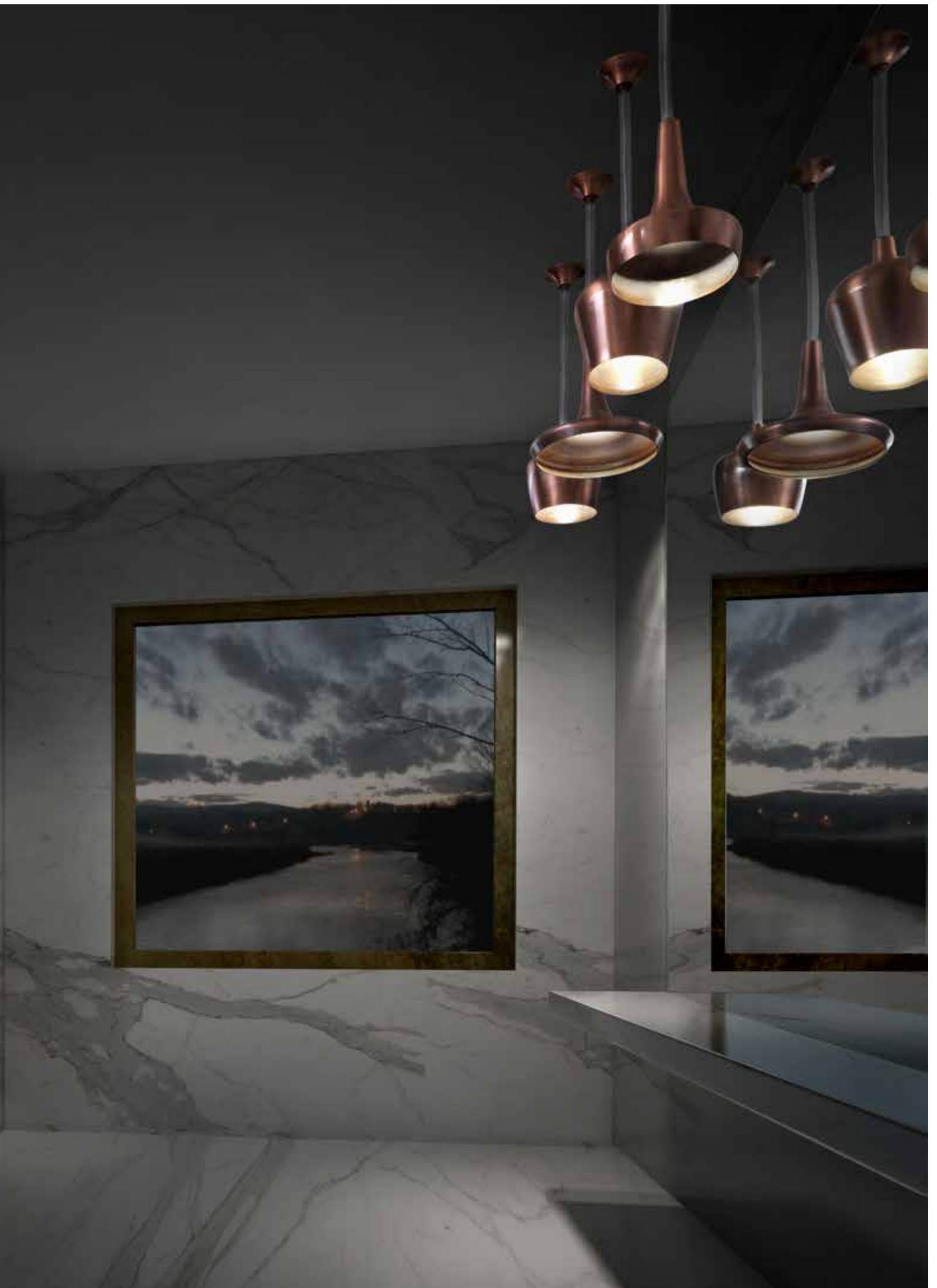

Il presente e il PASSATO si intrecciano in una vivace sintesi di giochi di acqua e di luce in memoria di epoche intramontabili.

Lively effects of light and water. Perfect blend between present and past.

Effets dynamiques entre eau et lumière où le présent et le passé se mélangent parfaitement.

Präsenz und Vergangenheit zusammen geflochten in einer lebendigen Synthese von Wasser- und Lichtspiel in Erinnerung an unvergänglichen Epochen.

## versione LAMPADARIO

ceiling lamp version also available

disponible aussi en version lustre

Hängelampe ebenfalls verfügbar









formae

*TR Studio Design*







stile e classicità

style and classicism

style et classicisme

Stil und Klassizismus



## colonna echo retrò

echo retro rising rail | colonne echo rétro | Duschpaneel echo Retro











## soffione retrò

retro shower head | pomme de tête rétro | Kopfbrause Retro

## saliscendi retrò

retro sliding bar | barre coulissante rétro | verstellbar Set Retro









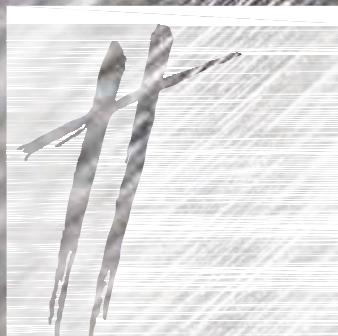

tender rain®

INOX



**prodotti 100%italiani** installazione indoor e outdoor  
installazione indoor e outdoor **DESIGN ESCLUSIVO** materie prime atossiche e certificate  
**CERTIFIED AND NON-TOXIC RAW MATERIALS** 100% made in Italy **EXCLUSIVE DESIGN**  
materie prime atossiche e certificate  
100% made in Italy **exclusive design** installazione indoor e outdoor  
exclusive design easy installation and maintenance **100% MADE IN ITALY**  
**FACILITÀ DI INSTALLAZIONE E MANUTENZIONE** easy installation and maintenance  
easy installation and maintenance 100% made in Italy **DESIGN ESCLUSIVO**  
**CERTIFIED AND NON-TOXIC RAW MATERIALS** 100% made in Italy



tender rain® risponde alle esigenze tecnico-estetiche del mercato ampliando la sua gamma di soluzioni doccia interamente fabbricate in Italia. Oltre alla consolidata produzione di articoli in ottone a basso tenore di piombo, l'esperienza nelle lavorazioni dei metalli ha portato all'implementazione delle collezioni in acciaio inossidabile.

Le tonalità fredde ed eleganti dell'acciaio rispondono al gusto minimalista imperante nel mondo del bagno, senza dimenticare le straordinarie prestazioni di questo materiale: resistenza alla corrosione, minima manutenzione, igiene ed eco-sostenibilità. Lavorazione con macchine a controllo numerico, scrupolosità della spazzolatura, collaudo di ogni singolo pezzo garantiscono, anche nelle collezioni in acciaio inox, il mantenimento degli alti livelli di precisione e qualità che contraddistinguono tender rain®. Tutti i prodotti sono fabbricati in acciaio inossidabile italiano certificato: AISI 316L e AISI 304L.

The technical and aesthetic needs of the market led tender rain® to a great extension of its range of Italian shower solutions. In addition to all the products in low-lead solid brass, the outstanding experience in metal processing techniques resulted in new amazing collections in stainless steel.

The cold and elegant shades of steel meet the minimalist taste that prevails in the current bathroom inspiration style, together with the noteworthy performances of this raw material: hygiene, environmental sustainability and the highest resistance to corrosion. Thanks to the use of CNC machines, the scrupulous brushing operations and the accurate test of every single piece, tender rain® assures its high precision standards also in this new repertoire, which is made in AISI 316L and AISI 304L Italian certified stainless steel.

tender rain® répond aux besoins techniques et esthétiques du marché en élargissant sa gamme de solutions de douche entièrement fabriquées en Italie. En plus de la production consolidée d'articles en laiton, l'expérience dans les techniques de traitement des métaux a conduit à la mise en œuvre des collections en acier inoxydable. Les nuances froides et élégantes de l'acier répondent au goût minimaliste qui prévaut dans le monde de la salle de bains, sans oublier les performances extraordinaires de ce matériau: résistance à la corrosion, entretien minimal, hygiène et durabilité environnementale. L'utilisation professionnelle de machines à commande numérique, le brossage scrupuleux et le contrôle de chaque pièce garantissent, même dans les collections en acier inoxydable, le maintien des hauts niveaux de précision et de qualité qui distinguent tender rain®. Tous les produits sont fabriqués en acier inoxydable italien certifié: AISI 316L et AISI 304L.

tender rain® geht auf die technisch-ästhetischen Anforderungen des Marktes ein, indem sie ihre Produktpalette für Duschen erweitert, die vollständig in Italien gefertigt werden. Neben der bereits fest verankerten Herstellung von Artikeln in bleiarmen Kupfer hat die Erfahrung in der Verarbeitung von Metallen zu der Einführung der Kollektionen in rostfreiem Stahl geführt.

Die kühlen und eleganten Farbtöne des Stahls entsprechen dem vorherrschenden minimalistischen Geschmack in der Welt des Bades, ohne die hervorragenden Eigenschaften dieses Materials zu vergessen: Korrosionsbeständigkeit, minimaler Pflegeaufwand, Hygiene und ökologische Nachhaltigkeit. Die Verarbeitung durch Maschinen mit numerischer Steuerung, die Sorgfältigkeit beim Bürsten des Stahls sowie die Abnahmekontrolle bei jedem einzelnen Stück garantieren, auch bei den Kollektionen in Edelstahl, die Einhaltung des hohen Niveaus in Präzision und Qualität, die tender rain® ausmachen. Alle Produkte werden aus zertifiziertem italienischen rostfreien Stahl hergestellt: AISI 316L und AISI 304L.







# petalo romboidale

Petalo rhomboidal model | Petalo modèle rhomboïdal | Petalo rhombisches Modell

*design Massimiliano Settimelli LDA.IMDA*

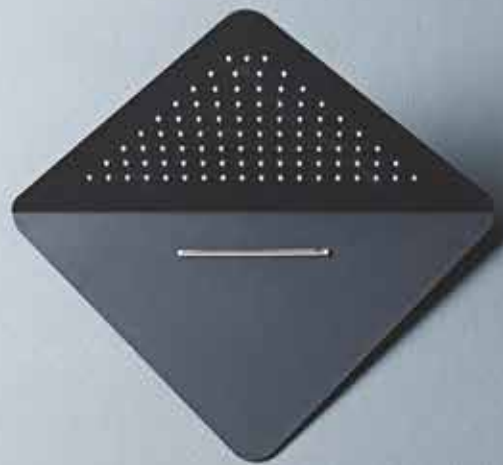

## ELEMENTO LEGGERO E DELICATO

esile a tal punto da sembrare un petalo, dalla personalità ben definita e accattivante.

Light and delicate element, slender like a petal, with a capturing design.

Élément délicat, assez léger pour ressembler à un pétale, avec une personnalité bien définie et captivante.

Leichtes und zartes Element, schlank genug, um wie ein Blütenblatt auszusehen, mit einer gut definierten und fesselnden Persönlichkeit.











# petalo tondo

Petalo round model | Petalo modèle ronde | Petalo rundes Modell

*design Massimiliano Settimelli LDA.IMDA*



## ELEMENTO LEGGERO E DELICATO

esile a tal punto da sembrare un petalo, dalla personalità ben definita e accattivante.

Light and delicate element, slender like a petal, with a capturing design.

Élément délicat, assez léger pour ressembler à un pétale, avec une personnalité bien définie et captivante.

Leichtes und zartes Element, schlank genug, um wie ein Blütenblatt auszusehen, mit einer gut definierten und fesselnden Persönlichkeit.

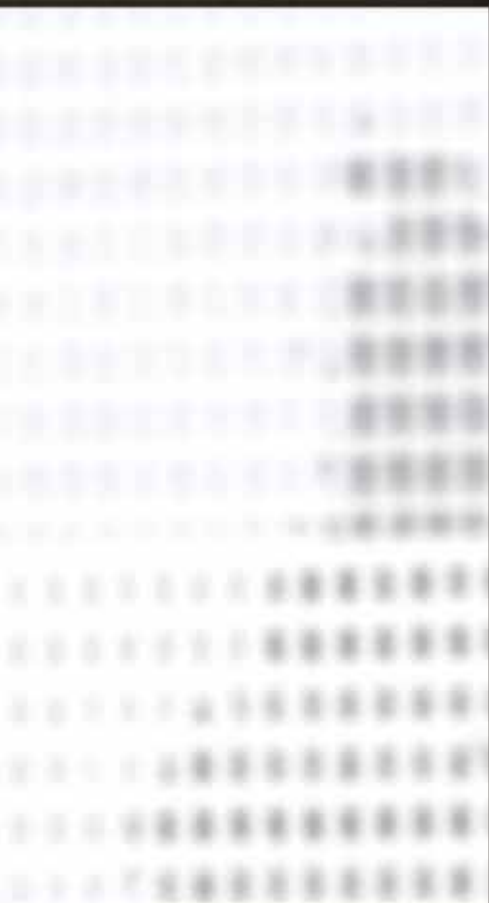







babordo

*design Mihran Rovelli Manoukian*





## ACCIAIO INOSSIDABILE

e legno massello si affiancano definendo geometrici ritmi tipici delle coperte delle barche a vela.

Stainless steel and solid wood, placed alongside, create geometric lines able to evoke the lure of a sailing boat deck.

Acier inoxydable et bois massif accompagnent un design et une définition géométrique qui évoquent le côté typique d'un pont de bateau à voile.

Edelstahl und Massivholz stehen in dem Design Seite an Seite und mit der Definition von den typischen geometrischen Rhythmen des Decks eines Segelschiffes.





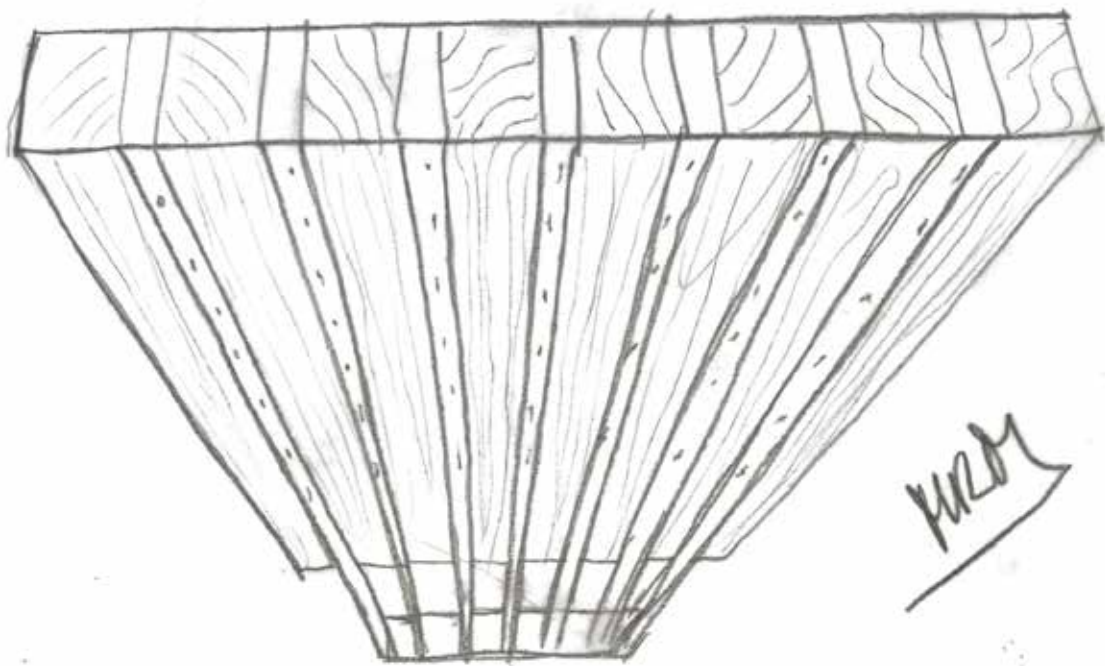
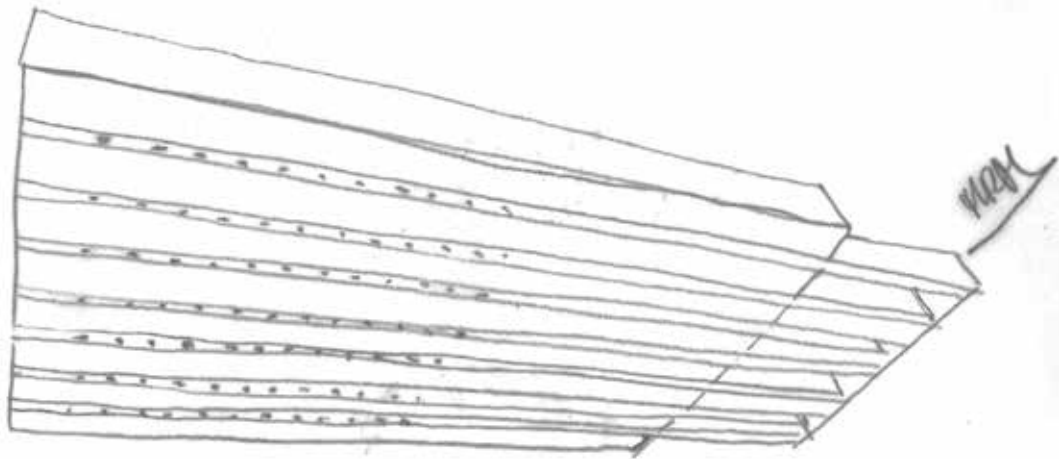

*design Mihran Rovelli Manoukian*

premio conferito dal Chicago Athenaeum: Museo di Architettura e Design  
as awarded by the Chicago Athenaeum: Museum of Architecture and Design



brevettato | patented | breveté | patentiert



## soffione Jetto

jetto shower head | pomme de tête jetto | Kopfbrause jetto

*design Luca Scacchetti*

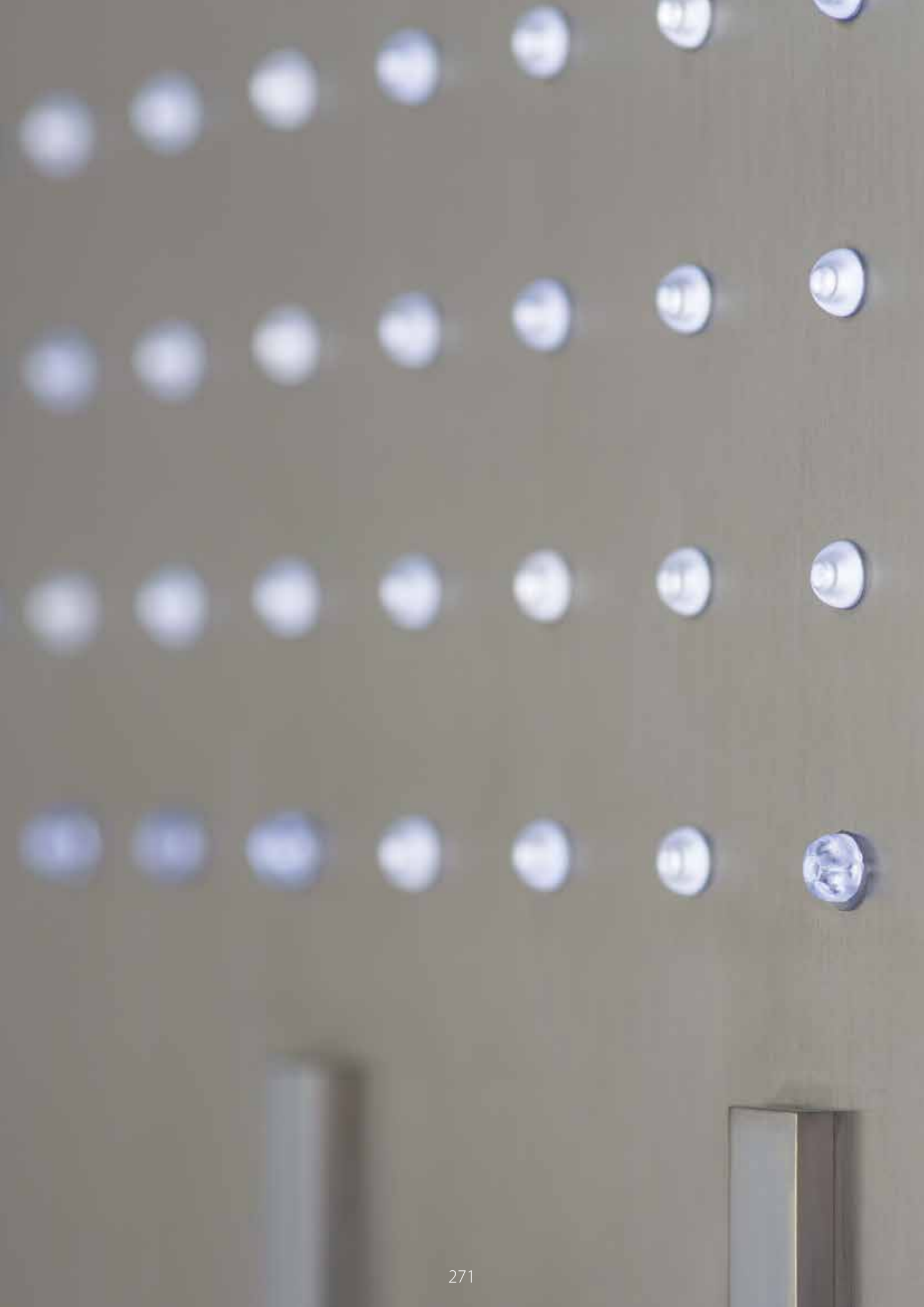



L'elegante essenzialità non disdegna il piacere della completezza. Jetto la incrementa con cascata, cromoterapia e acciaio inox.





Comandi cromoterapia pagine 178-179

Chromotherapy controllers pages 178-179

Contrôleurs pour chromothérapie pages 178-179

Steuergeräte für Farbtherapie Seiten 178 -179

Elegant simplicity does not disdain the pleasure of completeness. Jetto aims at refining it with waterfall, chromotherapy and stainless steel.

L'élégance du minimalisme ne dédaigne pas le plaisir de l'exhaustivité. Jetto la complète avec cascade, chromothérapie et acier inox.

Eleganz und Wesentlichkeit. Neu Jetto aus Edelstahl mit Farbtherapie und Wasserfall.



estante

*GM design*







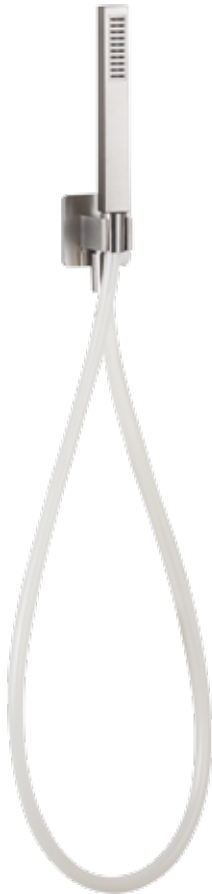



## bocca cascata a muro Mini Estante

Mini Estante wall mounted waterfall spout

Bec cascade Mini Estante

Mini Estante Wasserfall für Wandmontage



# soffione multifunzione

multifunction shower head | pomme de tête multifonction | multifunktions Kopfbrause

*TR Studio Design*



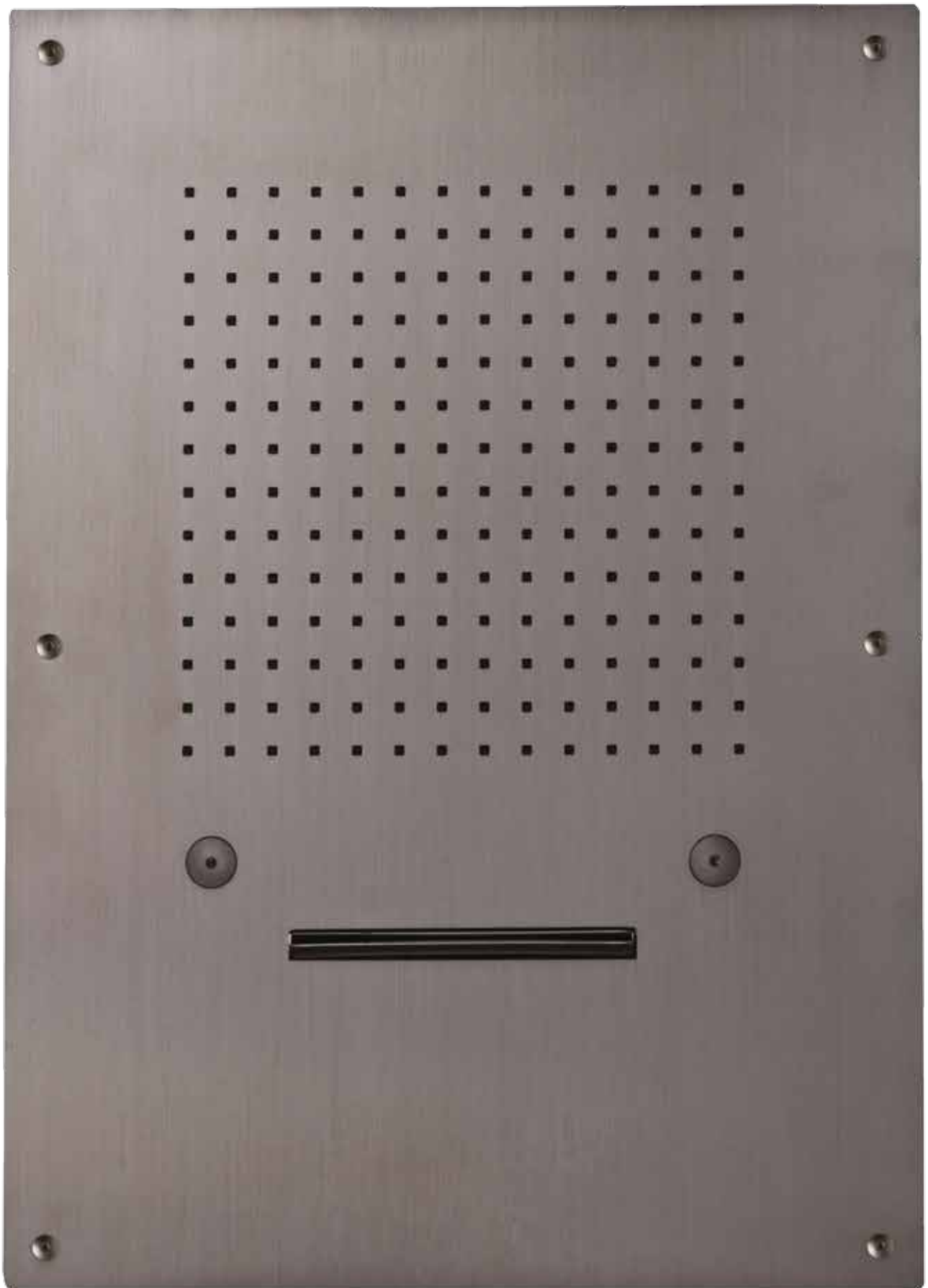







# colonna C3

C3 column | colonne C3 | Duschsäule C3

*TR Studio Design*



C3



## set da muro

wall mounted shower sets | sets de douche muraux | Dusche Set für Wandmontage

*TR Studio Design*





bocca cascata a muro Megara

Megara wall mounted waterfall spout

Cascade encastrée Megara

Megara wasserfall für Wandmontage









## bocca cascata a muro Minoa

Minoa wall mounted waterfall spout

Bec cascade Minoa

Minoa Wasserfall für Wandmontage



## colonna X0

X0 shower column | colonne de douche X0 | Duschsäule X0

*TR Studio Design*







tender rain®

OUTDOOR

brevettato | patented | breveté | patentiert



## colonna menhir

menhir rising rail | colonne menhir | Duschpaneel menhir

*design Luca Scacchetti*





INCORRUTTIBILE,

senza cedimenti, come una stele ritrovata assoluta nella sua forma con misteriosi dettagli e nicchie.

Pilastro con reggi trave e mensole, superstite di un tempo dedicato al bagno o a tutte le *divinità acquatiche*.

Majestic and imposing pillar, with hidden recesses, mindful icon of ancient times, devoted to aquatic divinities.

Majestueuse et imposante colonne avec précieux détails caches. Icône qui évoque un temps éternel dédié aux divinités aquatiques.

Unbestechlich, ohne Nachzugeben, wie eine wiedergefundene Stele, absolut in der Form mit mysteriösen Details und Ausbuchtungen. Säule mit Leisten und Schrank, gerettet aus einer Zeit, die dem Baden und allen Wassergöttern gewidmet war.









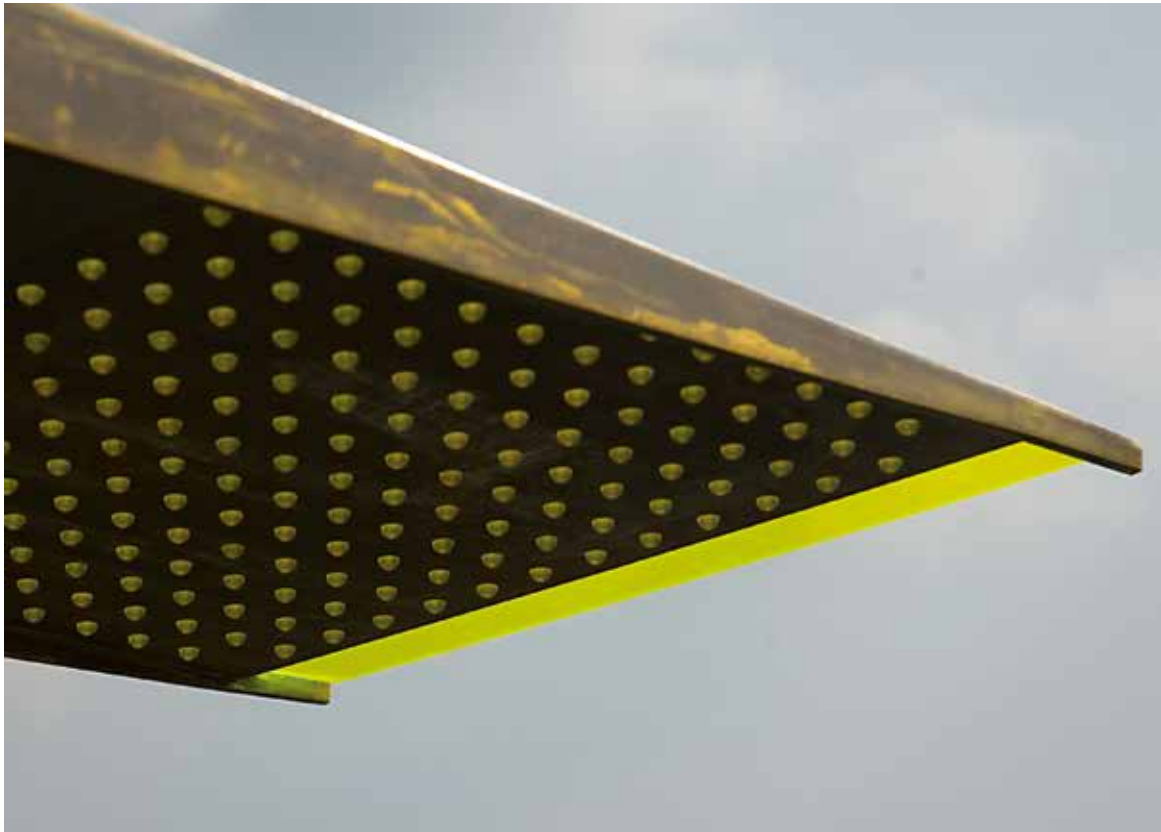

Un tocco di luce che rende Menhir ancora più  
unica ed esclusiva.

This touch of light makes Menhir even more unique.

Touche de lumière qui rend Menhir encore plus exclusive.

Eine Spur von Licht macht Menhir noch einzigartiger und exklusiver.



## doccetta estraibile

extractable handshower

douchette extractible

ausziehbare Handbrause





brevettato | patented | breveté | patentiert



## colonna sharp

sharp rising rail | colonne sharp | Duschpaneel sharp

*design Luca Scacchetti*







Unicità della maniglia, morbida leggerezza  
inserita nella scultorea soluzione architettonica  
dell'insieme.

Uniqueness of the handle: seductive sinuosity in a sculptural context.

Unicité de la poignée: sinuosité séduisante dans un contexte sculptural.

Die Einmaligkeit des Griffs, weiche Leichtigkeit eingefügt in die architektonische, skulpturische Gesamtlösung.





*SHARP studio formale, concept design*



## colonna R1

R1 rising rail | colonne R1 | Duschpaneel R1

## gruppo lavapiedi

foot-rinse station | borne rince-pieds | Mischer bodenstehend

*TR Studio Design*





## gruppo lavapiedi

foot-rinse station

borne rince-pieds

Mischer bodenstehend



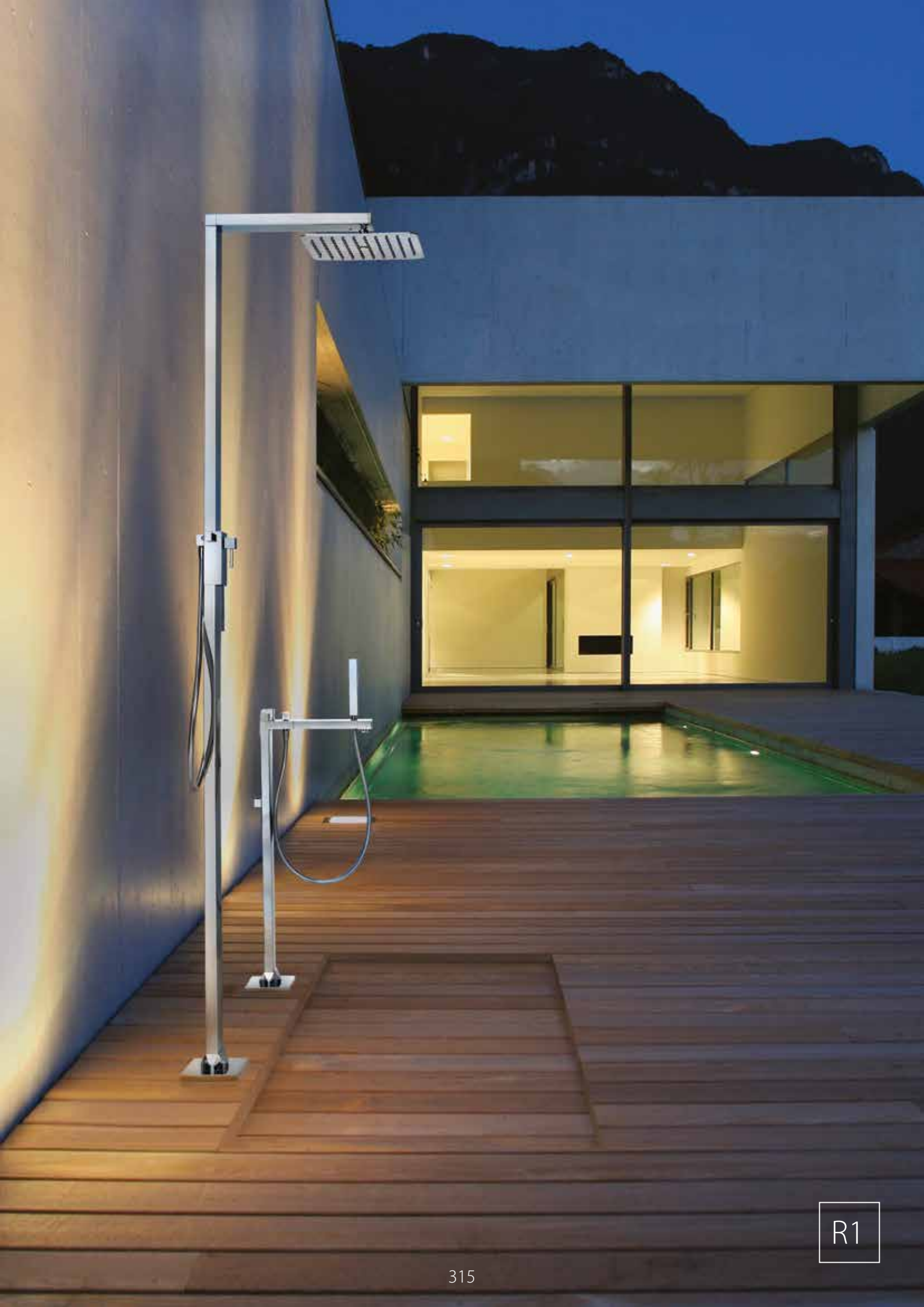

R1



## colonne C1 e C3

C1 and C3 rising rails | colonnes C1 et C3 | Duschpaneele C1 und C3

*TR Studio Design*

C1

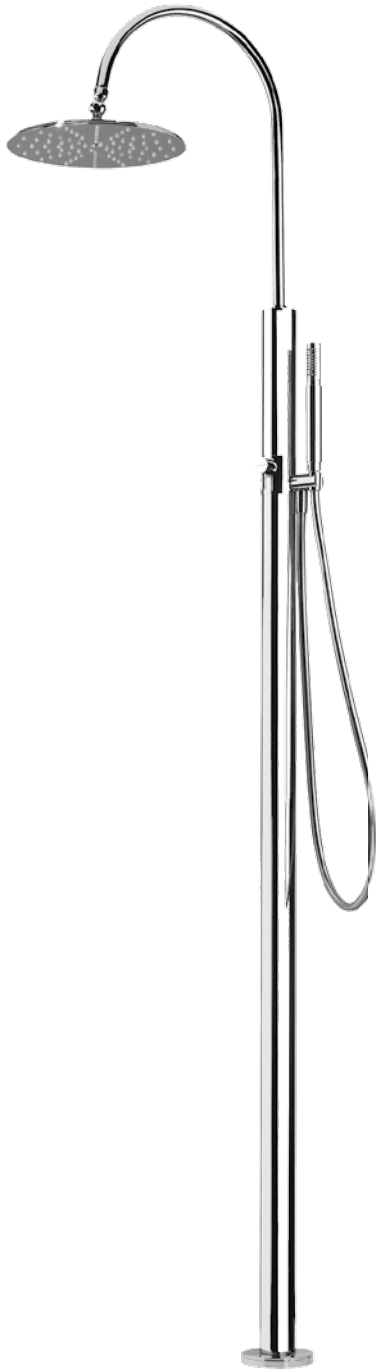

ottone

brass  
laiton  
Messing

C3



ottone

brass  
laiton  
Messing

C3



acciaio inox

stainless steel  
acier inoxydable  
Edelstahl





C1







C3



## set a parete menhir

menhir wall mounted set | set douche mural menhir | Wandmontage Set menhir

*design Luca Scacchetti*

## set a parete

wall mounted sets | sets douche muraux | Wandmontage Set









# Set a parete con soffione a scelta

Wall mounted set with shower head by choice

Set douche mural avec pomme de tête au choix

Wandmontage Set mit Kopfbrause nach Belieben



# finiture

finishes

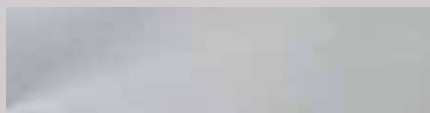

cod. 1  
cromato  
chrome plated

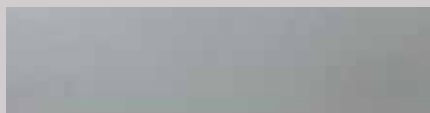

cod. 22  
cromo spazzolato  
brushed chrome

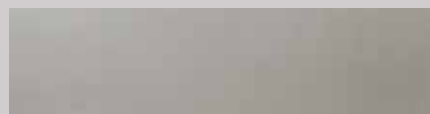

cod. 2  
nichel spazzolato  
brushed nickel



cod. 4  
ottone ad invecchiamento naturale  
old natural brass

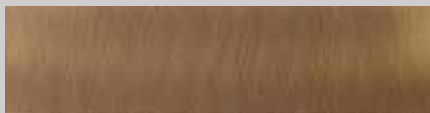

cod. 6  
bronzo spazzolato  
brushed bronze



cod. 7  
rame spazzolato  
brushed copper

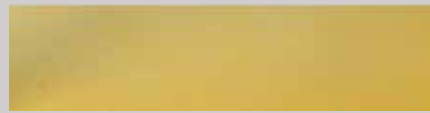

cod. 11  
oro classico lucido  
gold plated



cod. 13  
nero opaco  
mat black



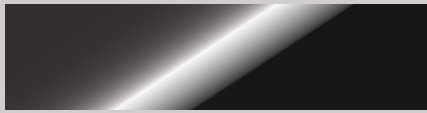

cod. 16  
nero lucido  
glossy black

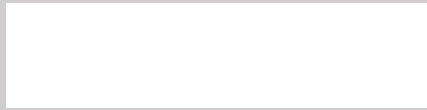

cod. 15  
bianco opaco  
mat white



cod. 0  
acciaio inox spazzolato  
brushed stainless steel



cod. 94  
titan  
mat titan



cod. 92  
oro rosa  
rose gold

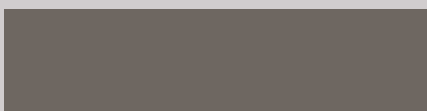

cod. 95  
grafite  
graphite



cod. 91  
oro chiaro  
pale gold



cod. 93  
oro intenso  
intense gold

disponibili vernici ral  
ral painted finishes available



direzione artistica | art directors | directeurs artistiques | künstlerische Leiter

arch. Luca Scacchetti  
Barbara Branciforti

fotografi | photographers | photographes | Fotografen

Pietro Carrieri  
Luca Casonato  
Tommaso Iuliano  
Stefano Anchisi  
Pier Nicola Bruno  
IKB Fotografia

si ringrazia | thanks to | merci à | vielen Dank

Bencore  
Edilcuoghi  
Florim  
L.M.I.  
Makro  
Omnidecor  
R.A.R.E.  
Acquaterra

# note

note

# note

# note



 tender rain®

Via Brughiera IV n. 9, 28010 Boca (NO)

Tel. +39 0163 028911 - Fax +39 0163 47818 - [info@tenderrain.com](mailto:info@tenderrain.com) - [www.tenderrain.com](http://www.tenderrain.com)

Numero Verde  
**800 734 406**