

For fifty
years,
we've been
bringing
beauty
into
people's
lives

50  **Tagina**
Anniversary ITALY'S BEST SURFACES
| 1973 | 2023

INDICE ALFABETICO

ALPHABETICAL INDEX.
INDEX ALPHABETIQUE.
ALPHABETISCHES INHALTSVERZEICHNIS.

APOGEO 224
AURUM STONE 162
CALACATTA GOLD 318
CONCRETA 208
DECORS 369
DEEP BLUE 156
EVOQUE 350
FULL COLOURS 240
ILCOTTOTAGINA 108
LILAC 304
MARQUINA 342
MEDITERRANEA 64
METAL 192
NAMUR 90
ONICE REALE 260
PATAGONIA 276
PIETRA DI LUNA 176
PIETRA D'ORVIETO 28
PIETRA REGALE 140
ROMA 288
SEGESTA 326
STATUARIO 310
UMBRIA ANTICA 126



STONE & CLASSIC

PIETRA D'ORVIETO 28
MEDITERRANEA 64
NAMUR 90
ILCOTTOTAGINA 108
UMBRIA ANTICA 126
PIETRA REGALE 140
DEEP BLUE 156
AURUM STONE 162



CONCRETE & DESIGN

PIETRA DI LUNA 176
METAL 192
CONCRETA 208
APOGEO 224
FULL COLOURS 240



MARBLE & ONYX

ONICE REALE 260
PATAGONIA 276
ROMA 288
LILAC 304
STATUARIO 310
CALACATTA GOLD 318
SEGESTA 326
MARQUINA 342



WOOD

EVOQUE 350



DECORS

FOREST 370
JAY VINTAGE 372
GARDENS 374



OUTDOOR

PIETRA D'ORVIETO 28
MEDITERRANEA 64
NAMUR 90
ILCOTTOTAGINA 108
UMBRIA ANTICA 126
PIETRA REGALE 140
DEEP BLUE 156
AURUM STONE 162
METAL 192
CONCRETA 208
APOGEO 224
EVOQUE 350

INDICE GENERALE PER COLORI 4

INDEX BY COLOURS
INDEX DES COULEURS
INHALTSVERZEICHNIS NACH FARBEN.

INDICE GENERALE PER SPESSORE 6

INDEX BY THICKNESS.
INDEX DES EPAISSEURS.
INHALTSVERZEICHNIS NACH STÄRKE.

CHI È TAGINA 8

ABOUT TAGINA
QUI EST TAGINA
WER IST TAGINA?

INDICE INFORMAZIONI TECNICHE 379

TECHNICAL INFORMATION INDEX.
INDEX DES INFORMATIONS TECHNIQUES.
INHALTSVERZEICHNIS TECHNISCHE INFORMATIONEN.

INDOOR 380

Soluzioni per complementi di arredo 380

Solution for furniture.
Solutions pour les accessoires d'ameublement.
Lösungen, um Einrichtungen zu gestalten.

Pezzi speciali 384

Special pieces.
Pièces spéciales.
Spezialteile.

OUTDOOR 386

Pezzi speciali per esterno 390

Special pieces for outdoor.
Pièces spéciales pour l'extérieur.
Formteile für Aussenbereich.

Pezzi speciali per piscina 391

Special pieces for swimming pool.
Pièces spéciales pour piscine.
Formteile für Schwimmbad.

IMBALLI 416

Packaging.
Emballage.
Verpackung.

SERVIZIO CONSEGNE FINO A SASSUOLO 416

Delivery service to Sassuolo.
Service de livraisons jusqu'à Sassuolo.
Lieferservice bis nach Sassuolo.

CERTIFICAZIONI 417

Certifications.
Certifications.
Zertifizierung.

CATALOGHISTICA TECNICA 417

Technical catalogues.
Catalogues techniques.
Technische Kataloge.

CONDIZIONI GENERALI DI VENDITA 418

General terms and conditions of sale.
Condition générales de vente.
Allgemeine Verkaufsbedingungen.

CARATTERISTICHE TECNICHE 422

Technical features.
Caractéristiques techniques.
Technische Eigenschaften.

INDICE GENERALE PER COLORI

INDEX BY COLOURS

INDEX DES COULEURS

INHALTSVERZEICHNIS NACH FARBEN.

STONE & CLASSIC

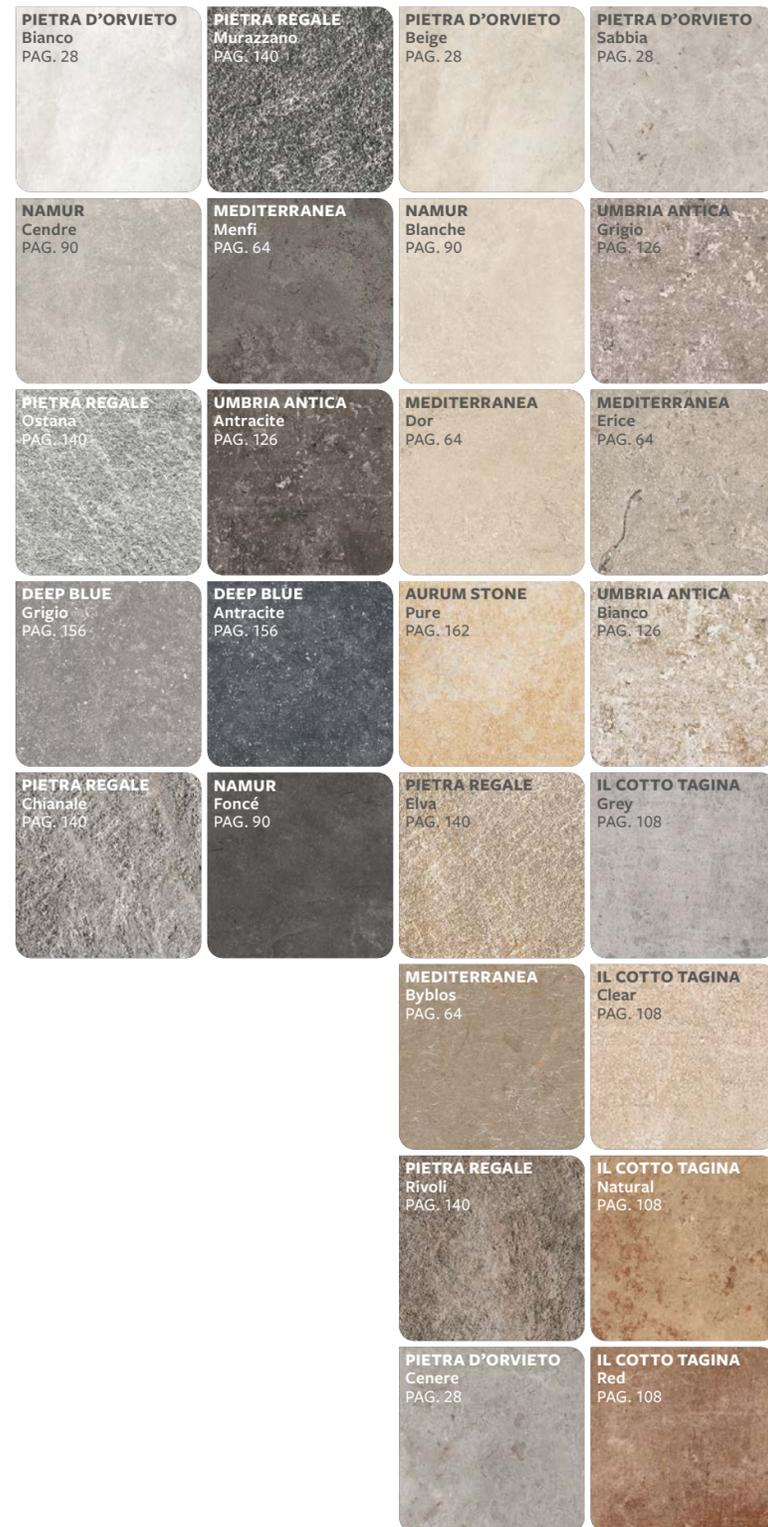

CONCRETE & DESIGN



MARBLE & ONYX

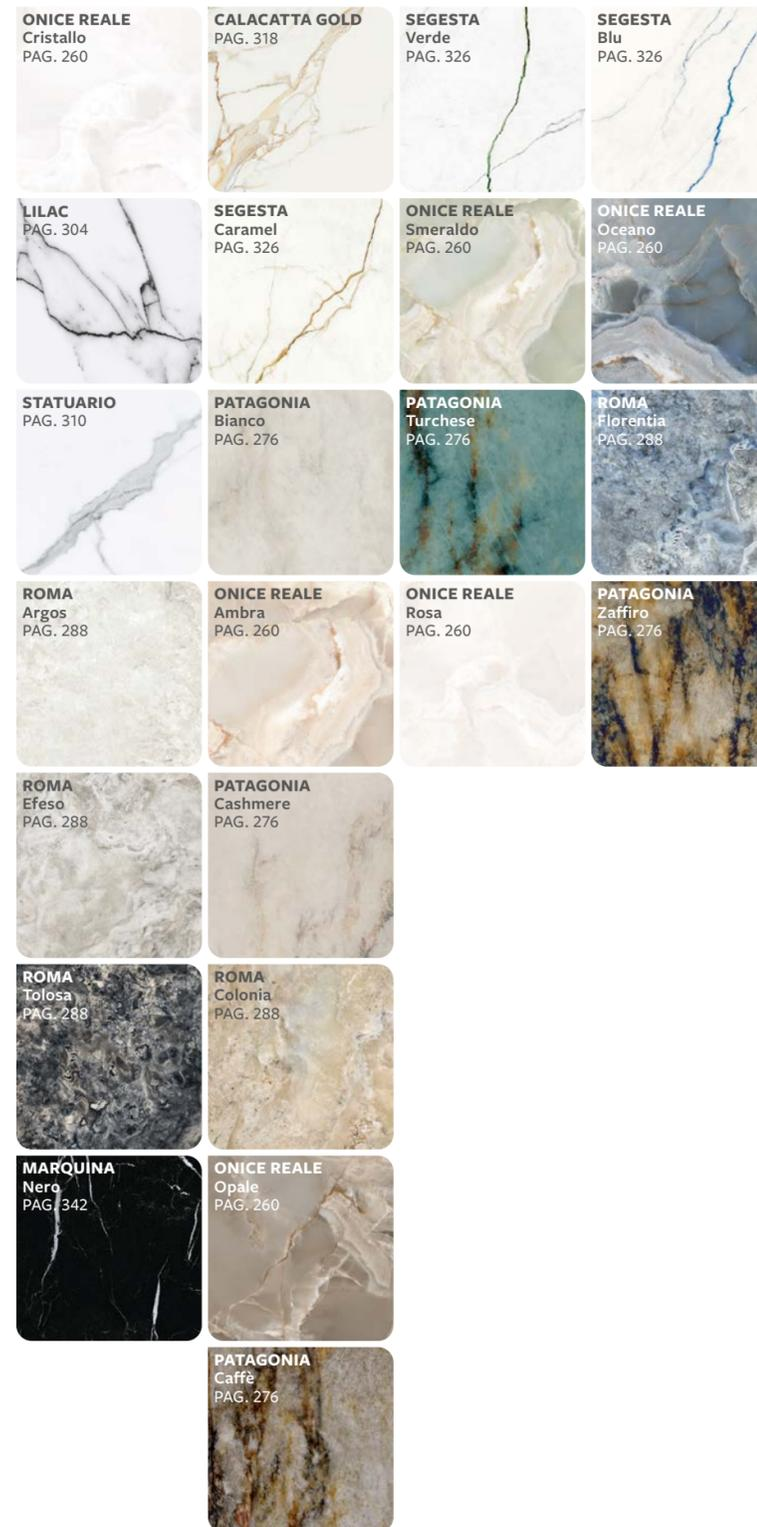

WOOD



INDICE GENERALE PER SPESSORE

INDEX BY THICKNESS.

INDEX DES EPAISSEURS.

INHALTSVERZEICHNIS NACH STÄRKEN.



INDOOR

Pavimenti . Rivestimenti . Soluzioni per complementi d'arredo

Floor tiles . Wall tiles . Solution for furniture

Sols . Revêtements . Solutions pour les accessoires d'ameublement

Böden . Wandbeläge . Lösungen, um Einrichtungen zu gestalten

6 mm

SPESSORE
THICKNESS
EPAISSEUR
STÄRKE

GRANDI LASTRE
SLABS
DALLES
GROSSARTIGE PLATTEN

APOGEO 224

CALACATTA GOLD 318

CONCRETA 208

DECORS 369

FULL COLOURS 240

LILAC 304

MARQUINA 342

METAL 192

ONICE REALE 260

PATAGONIA 276

PIETRA D'ORVIETO 28

SEGESTA 326

STATUARIO 310

9/10 mm

SPESSORE
THICKNESS
EPAISSEUR
STÄRKE

GRES PORCELLANATO
PORCELAIN TILES
GRES CERAME
FEINSTEINZEUG

APOGEO 224

AURUM STONE 162

CALACATTA GOLD 318

CONCRETA 208

DECORS 369

EVOQUE 350

FULL COLOURS 240

ILCOTTOTAGINA 108

LILAC 304

MARQUINA 342

MEDITERRANEA 64

METAL 192

NAMUR 90

ONICE REALE 260

PATAGONIA 276

PIETRA DI LUNA 176

PIETRA D'ORVIETO 28

PIETRA REGALE 140

ROMA 288

SEGESTA 326

STATUARIO 310

UMBRIA ANTICA 126

12 mm

SPESSORE
THICKNESS
EPAISSEUR
STÄRKE

GRANDI LASTRE
SLABS
DALLES
GROSSARTIGE PLATTEN

FULL COLOURS 240

20 mm

SPESSORE
THICKNESS
EPAISSEUR
STÄRKE

GRANDI LASTRE
SLABS
DALLES
GROSSARTIGE PLATTEN

FULL COLOURS 240



OUTDOOR

Pavimenti

Floor tiles

Sols

Böden

9/10 mm

SPESSORE
THICKNESS
EPAISSEUR
STÄRKE

GRES PORCELLANATO
PORCELAIN TILES
GRES CERAME
FEINSTEINZEUG

APOGEO 224

CONCRETA 208

EVOQUE 350

ILCOTTOTAGINA 108

MEDITERRANEA 64

PIETRA D'ORVIETO 28

PIETRA REGALE 140

UMBRIA ANTICA 126

20 mm

SPESSORE
THICKNESS
EPAISSEUR
STÄRKE

GRES PORCELLANATO
PORCELAIN TILES
GRES CERAME
FEINSTEINZEUG

APOGEO 224

AURUM STONE 162

CONCRETA 208

DEEP BLUE 156

EVOQUE 350

ILCOTTOTAGINA 108

MEDITERRANEA 64

METAL 192

NAMUR 90

PIETRA D'ORVIETO 28

PIETRA REGALE 140

UMBRIA ANTICA 126

30 mm

SPESSORE
THICKNESS
EPAISSEUR
STÄRKE

GRES PORCELLANATO
PORCELAIN TILES
GRES CERAME
FEINSTEINZEUG

APOGEO 224

CONCRETA 208

ILCOTTOTAGINA 108

PIETRA D'ORVIETO 28

PIETRA REGALE 140

UMBRIA ANTICA 126

Chi è tagina

ABOUT TAGINA
QUI EST TAGINA
WER IST TAGINA?



Una storia che continua a emozionare

A STORY THAT CONTINUES TO INSPIRE
UNE PASSION QUI NE FINIT JAMAIS
EIN UNTERNEHMEN, DAS SEINE KUNDEN IMMER
WIEDER AUFS NEUE ÜBERRASCHT

50
Anniversary
| 1973 | 2023

1973-2023: da 50 anni siamo protagonisti di una storia che ha affascinato e continua ad affascinare tutto il mondo. Pagine di eccellenza dell'Italian Style, capacità e visione di anticipare le tendenze, e volontà di portare la bellezza nella vita di tutte le persone, realizzando superfici che raccontano il tempo, la tradizione e la contemporaneità. Dando vita a racconti sempre originali e particolari. Questa storia giunge oggi a un importante e prestigioso traguardo. Punto di arrivo, e al tempo stesso rilancio, per continuare a scrivere nuovi, emozionanti capitoli di passione, ricercatezza ed eleganza.

1973-2023: for 50 years we have been the protagonists of a story that has fascinated and continues to fascinate the entire world. Italian style excellence, ability and vision to anticipate trends, and the desire to bring beauty into everyone's life, creating surfaces that tell the story of time, tradition, and modernity. Giving life to tales that are always original and special. Today this story reaches an important and prestigious milestone. A finish line but also just a stepping stone, to continue writing new, exciting chapters of passion, refinement, and elegance.

1973-2023 : depuis 50 ans nous sommes les protagonistes d'une histoire qui a fasciné et continue de fasciner le monde entier. Pages d'excellence du Style Italien, capacité et anticipation des tendances, volonté d'embellir la vie de tous, en créant des surfaces qui racontent le temps, la tradition et la contemporanéité. En donnant vie à des histoires toujours originales et particulières. Aujourd'hui, cette histoire franchit une étape importante et prestigieuse. Point d'arrivée et en même temps de relance, pour continuer à écrire de nouveaux chapitres émouvants de passion, de raffinement et d'élégance.

1973-2023: Seit 50 Jahren sind wir die Protagonisten einer Geschichte, die die ganze Welt fasziniert hat und weiterhin fasziniert. Exzellenter italienischer Stil, die Fähigkeit und der Weitblick, Trends zu antizipieren, und der Wunsch, Schönheit in das Leben der Menschen zu bringen und Oberflächen zu schaffen, die die Zeit, die Tradition und die Gegenwart widerspiegeln. So entstehen Geschichten, die immer einzigartig und besonders sind. Diese Geschichte erreicht heute einen wichtigen und prestigeträchtigen Meilenstein. Ein Ankunftspunkt und gleichzeitig ein Neustart, um neue, aufregende Kapitel voller Leidenschaft, Raffinesse und Eleganz zu schreiben.



Tagina: 50 anni di storia

TAGINA: 50 YEARS OF HISTORY
TAGINA : 50 ANS D'HISTOIRE
TAGINA: 50 JAHRE GESCHICHTE

Tagina nasce nel 1973 in Umbria a Gualdo Tadino. Il nostro rapporto col territorio è fin da subito strettissimo tant'è che i fondatori scelgono di chiamare l'azienda con l'antico nome della città: TAGINA. Città e territorio che, a partire dal Rinascimento, vantano una rinomata tradizione nella produzione artigianale della ceramica e della sua decorazione (famosa è la tecnica di decorazione "a lustro" che Giorgio Andreoli da Gualdo Tadino inventò nel 1400).

Tagina was born in 1973 in the Umbria region in Gualdo Tadino. Our relationship with the territory is very close right from the start, so much so that the founders choose to call the company with the ancient name of the city: TAGINA. A city and territory that, starting from the Renaissance, can boast a renowned tradition in the handicraft production of ceramics and its decoration (a famous example is the "luster" decoration technique invented by Giorgio Andreoli da Gualdo Tadino in the 1400s).

Tagina nait en 1973 à Gualdo Tadino en Ombrie. Notre rapport avec le territoire est depuis le début très étroit, à tel point que les fondateurs choisissent d'appeler l'entreprise par l'ancien nom de la ville : TAGINA. Une ville et un territoire qui, à partir de la Renaissance, profitent d'une tradition importante dans la production artisanale de la céramique et de sa décoration (une technique connue est celle de la décoration à lustre inventée par Giorgio Andreoli de Gualdo Tadino au XVème siècle).

Tagina wurde 1973 in Gualdo Tadino, Umbrien, gegründet. Die Beziehung der Firmengründer zu ihrer Region war von Anfang an so eng, dass sie beschlossen, das Unternehmen nach dem alten Namen der Stadt zu benennen: TAGINA. Stadt und Region, die sich seit der Renaissance einer berühmten Tradition in der handwerklichen Herstellung von Keramik und deren Verzierung rühmen können (berühmt ist die von Giorgio Andreoli da Gualdo Tadino im 15. Jh. erfundene Dekorationstechnik „Lüster“).



Tra illustri collaborazioni con la Moda, col mondo dell'architettura, tra prodotti premiati ed innovativi al punto da avviare una tendenza di mercato, TAGINA taglia il traguardo dei 50 anni di storia.

Among illustrious collaborations with fashion, with the world of architecture, among award-winning and innovative products to the point of starting a market trend, TAGINA crossed the milestone of 50 years of history.

Entre grandes collaborations avec la Mode et avec le monde de l'architecture, entre produits récompensés et innovants au point de lancer une tendance de marché, TAGINA franchit l'étape des 50 ans d'histoire.

Mit bedeutenden Kollaborationen mit der Welt der Mode und der Architektur und mit preisgekrönten, innovativen Produkten, die Trends setzen, kann TAGINA auf ein 50-jähriges Bestehen zurückblicken.



Tagina rivoluziona la funzionalità della ceramica: non solo come elemento "di servizio" ma come elemento di decorazione e finitura degli ambienti. TAGINA avvia l'innovativa collaborazione, per il settore ceramico, col mondo della Moda e sceglie LAURA BIAGIOTTI.

Tagina revolutionises the functionality of ceramics: not only as a "service" element but as an element of decoration and finishing of the rooms. TAGINA starts the innovative collaboration, for the ceramic sector, with the world of fashion and chooses LAURA BIAGIOTTI.

Tagina révolutionne la fonctionnalité de la céramique : pas seulement en tant qu'élément « de service » mais aussi comme élément de décoration et de finition des espaces. TAGINA lance l'innovante collaboration, pour le secteur céramique, avec le monde de la Mode et choisit LAURA BIAGIOTTI.

Tagina revolutioniert die Funktionalität von Keramik: nicht nur als „Service“-Element, sondern als Element zur Dekoration und optischen Aufwertung von Räumen. TAGINA startet eine innovative Zusammenarbeit mit der Modewelt im Bereich der Keramik und entscheidet sich für LAURA BIAGIOTTI.



Anno di fondazione.
Foundation year.
Année de fondation.
Gründungsjahr.

1973

1980

1983

1988

2000

2008

2010

2015

2020

2021

2023



Tagina è la prima azienda a riprodurre un cotto in monocottura: apre una nuova tendenza del mercato.
Collezioni: Terraie di Tarsina e Antica Umbria.
Tagina is the first company to reproduce a single-fired terracotta: it opens up a new market trend.
Collections: Terraie di Tarsina and Antica Umbria.
Tagina est la première entreprise à reproduire une terre cuite en monocuisson : elle lance une nouvelle tendance de marché.
Collections : Terraie di Tarsina et Antica Umbria.
Tagina ist das erste Unternehmen, das Terrakotta im Einmalbrandverfahren herstellt und damit einen neuen Markttrend eröffnet. Kollektionen: Terraie di Tarsina und Antica Umbria.

50x50 cm
41x41 cm



Tagina innova e lancia i grandi formati in monocottura: 41x41 e 50x50 in 12 mm di spessore in controtendenza rispetto al mercato.
Tagina innovates and launches large single-fired formats: 41x41 and 50x50 in 12 mm thickness, in contrast to the market.
Tagina innove et lance les grands formats en monocuisson : 41x41 et 50x50 en 12 mm d'épaisseur en contre-tendance par rapport au marché.
Tagina führt Innovationen ein und bringt große Einmalbrand-Formate auf den Markt: 41x41 und 50x50 in 12 mm Stärke entgegen dem Markttrend.



TAGINA inizia a sperimentare il concetto di "total look": con la stilista LAURA BIAGIOTTI si disegnano collezioni per realizzare ambienti dove la ceramica riveste senza soluzione di continuità tutte le superfici dell'ambiente: dai pavimenti ai rivestimenti, dalle colonne ai piani lavabo.

TAGINA begins to experiment with the concept of "total look": with the stylist LAURA BIAGIOTTI, they design collections to create environments where ceramic seamlessly covers all the surfaces of the environment: from floors to walls, from columns to sink tops.

TAGINA commence à expérimenter le concept de « total look » : avec la styliste LAURA BIAGIOTTI elle crée des collections pour réaliser des espaces où la céramique revêt sans solution de continuité toutes les surfaces de la pièce : des sols aux murs, des colonnes aux plans de travail de salle de bain.

TAGINA beginnt mit dem Konzept des „Total Look“ zu experimentieren: Gemeinsam mit der Designerin LAURA BIAGIOTTI werden Kollektionen entworfen, um Umgebungen zu schaffen, in denen Keramikfliesen nahtlos alle Oberflächen des Raumes bedecken: von Böden bis zu Verkleidungen, von Säulen bis zu Waschtischplatten.



TAGINA lancia FUCINA: la prima piastrella in ceramica dal "vero" effetto metallico. Un successo mondiale.
TAGINA launches FUCINA: the first ceramic tile with a "real" metallic effect. A worldwide success.
TAGINA lance FUCINA : le premier carreau céramique au « vrai » effet métallique. Un succès mondial.
TAGINA bringt FUCINA auf den Markt: die erste Keramikfliese mit „echtem“ Metalleffekt. Ein Welterfolg.



Vince il concorso Architettura Ceramica ITA. Cappella della Misericordia.
It wins the Architecture Ceramics ITA competition. Cappella della Misericordia.
Elle remporte le concours Architecture Ceramica ITA. Chapelle de la Miséricorde.
Das Unternehmen gewinnt den Wettbewerb Architektur Ceramica ITA. Misericordia-Kapelle.



Tagina viene acquisita dal gruppo DAFIN.
Tagina is acquired by the DAFIN group.
Tagina est achetée par le groupe DAFIN.
Tagina wird von der DAFIN-Gruppe übernommen.



TAGINA: a primavera 2023 inizia i lavori di costruzione della nuova Showroom da 3.000 mq presso la propria sede a Castel Bolognese RA.
TAGINA: in spring 2023, construction work begins on the new 3,000 m² Showroom at its headquarters in Castel Bolognese RA.
TAGINA : au printemps 2023 commenceront les travaux de construction du nouveau Showroom de 3 000 m² au siège de Castel Bolognese RA.
TAGINA: Im Frühjahr 2023 beginnt das Unternehmen mit dem Bau seines neuen 3.000 m² großen Showrooms an seinem Geschäftssitz in Castel Bolognese (RA).

La territorialità

TERRITORIALITY
LA TERRITORIALITÉ
DIE REGION



EMILIA ROMAGNA
Castel Bolognese - Faenza

UMBRIA
Gualdo Tadino - Perugia



Siamo da sempre legati a territori che vantano una tradizione secolare nel campo della progettazione, produzione e decorazione ceramica. Inizialmente a Gualdo Tadino, in Umbria, terra d'origine del nostro brand, dove la ceramica è una vocazione millenaria profondamente radicata nella sua storia.

E ancor di più oggi a Castel Bolognese, nel Faentino, luogo in cui ha sede. Faenza, una città famosa nel mondo per la ceramica dove già nel I° secolo A.C. nacquero le prime fabbriche favorite dalle caratteristiche delle argille reperibili nel vicino fiume Lamone. Faenza, famosa al punto che il toponimo stesso "Faenza" è diventato sinonimo di ceramica (maiolica) in molte lingue, tra cui il francese (faïence) e l'inglese (faience). Siamo anche nel cuore dell'Emilia Romagna, culla di eccellenze industriali dalla ceramica all'automotive con Ferrari, Lamborghini o Ducati, dalla moda col Gruppo Max Mara all'alimentare con Barilla o Il Consorzio del Parmigiano Reggiano, dal fitness con Technogym al turismo e così via.

We have always been linked to territories that boast a centuries-old tradition in the field of ceramic design, production and decoration. This was initially in Gualdo Tadino, in the Umbria region, the homeland of our brand, where ceramics is a millennial vocation deeply rooted in its history.

And it applies even more today in Castel Bolognese, in the Faenza area, where it is based. Faenza, a city famous in the world for ceramics, where already in the 1st century BC the first factories were born, favoured by the characteristics of the clays found in the nearby Lamone river. Faenza, famous to the point that the toponym "Faenza" itself has become synonymous with ceramics (majolica) in many languages, including French (faïence) and English (faience). We are also located in the heart of the Emilia Romagna region, cradle of industrial excellence from ceramics to automotive with Ferrari, Lamborghini or Ducati, from fashion with the Max Mara Group to food with Barilla or the Parmigiano Reggiano Consortium, from fitness with Technogym, to tourism etc.

Nous sommes depuis toujours liés à des territoires qui jouissent d'une tradition séculaire dans le domaine de la conception, de la production et de la décoration céramique. Initialement à Gualdo Tadino, en Ombrie, terre d'origine de notre marque où la céramique est une vocation millénaire profondément ancrée dans son histoire.

Et encore plus aujourd'hui à Castel Bolognese, dans la région de Faenza, lieu où se trouve son siège. Faenza, une ville connue dans le monde de la céramique où dès le 1er siècle av. J.-C. naquirent les premières fabriques favorisées par les caractéristiques des argiles disponibles dans le fleuve Lamone situé à proximité. Faenza est si connue que le toponyme « Faenza » est devenu synonyme de céramique (faïence) dans de nombreuses langues, dont le français et l'anglais (faïence). Nous sommes dans le cœur de l'Émilie Romagne, berceau d'excellentes entreprises industrielles, de la céramique à l'automobile avec Ferrari, Lamborghini ou Ducati, de la mode avec le Groupe Max Mara à l'alimentaire avec Barilla ou le Consortium du Parmigiano Reggiano, du fitness avec Technogym au tourisme, et ainsi de suite.

Wir sind seit jeher mit Gebieten verbunden, die eine jahrhundertalte Tradition im Bereich des Designs, der Herstellung und der Dekoration von Keramik aufweisen. Zunächst in Gualdo Tadino, in Umbrien, der Ursprungsregion unserer Marke, wo die Keramik seit Jahrtausenden tief in der Geschichte verwurzelt ist.

Und heute noch mehr in Castel Bolognese in der Gegend von Faenza, wo das Unternehmen seinen Sitz hat. Faenza, eine für ihre Keramik weltberühmte Stadt, in der die ersten Manufakturen bereits im 1. Jahrhundert v. Chr. gegründet wurden, begünstigt durch die Eigenschaften des im nahe gelegenen Fluss Lamone gefundenen Tons. Faenza ist so berühmt, dass der Name der Stadt in vielen Sprachen zum Synonym für Keramik (Majolika) geworden ist, auch im Französischen (faïence) und Englischen (faience). Außerdem befinden wir uns im Herzen der Emilia Romagna, der Wiege der industriellen Exzellenz: von der Keramikerstellung bis zur Automobilindustrie mit Ferrari, Lamborghini oder Ducati, von der Modeindustrie mit Max Mara bis zur Lebensmittelherstellung mit Barilla oder dem Konsortium des Parmigiano Reggiano, vom Fitnesssektor mit Technogym bis zum Tourismus und so weiter.

100%

Made in Italy

MADE IN ITALY AL 100%

Siamo italiani al 100%: per la passione, la fantasia, la capacità di innovare e la qualità. Produciamo il 100% in Italia attingendo a piene mani dal genio artigianale tipico dei nostri luoghi per aggiungere valore al nostro prodotto industriale. È questa filosofia che ha dato vita a collezioni storiche come quelle firmate nei primi anni '80 dalla stilista Laura Biagiotti, quando si introdusse in fabbrica la tecnica artigianale del "colaggio" per realizzare pezzi speciali interamente hand-made come capitelli e fotofore, a corredo delle collezioni di piastrelle industriali per realizzare ambientazioni davvero uniche ed inimitabili. O Fucina, altra iconica collezione che nel 2006 stupì il mercato per la sua assoluta verosimiglianza al "metallo", suo riferimento di genere, reso possibile dall'uso in linea, per la prima volta, di vera polvere metallica da miscelare agli smalti ceramici.

We are 100% Italian: this is shown in our passion, imagination, the ability to innovate and quality. We produce 100% in Italy, drawing heavily on the craftsmanship typical of our places to add value to our industrial product.

It is this philosophy that gave birth to historical collections such as those signed in the early 1980s by the stylist Laura Biagiotti, when the artisan technique of "casting" was introduced into the factory to create entirely hand-made special pieces such as capitals and photophores collections of industrial tiles to create truly unique and inimitable settings.

O Fucina, another iconic collection that amazed the market in 2006 for its absolute likeness to "metal", its genre reference, made possible by the use, for the first time, of real metal powder to be mixed with ceramic glazes.

Nous sommes italiens à 100% : pour la passion, la fantaisie, la capacité à innover et la qualité. Nous produisons à 100% en Italie en puisant à pleines mains dans le génie artisanal typique de nos lieux pour ajouter de la valeur à notre produit industriel. C'est cette philosophie qui a donné vie à des collections historiques comme les collections signées au début des années 80 par la styliste Laura Biagiotti, lors de l'introduction en usine de la technique artisanale du « collage » pour réaliser des pièces spéciales entièrement faites à la main comme des chapiteaux et des photophores, qui accompagnent les collections de carreaux industriels pour réaliser des décors vraiment uniques et inimitables. O Fucina, autre collection iconique qui en 2006 surprit le marché pour sa vraisemblance absolue avec le « métal », sa référence de genre, rendue possible par l'utilisation en ligne, pour la première fois, de vraie poudre métallique à mélanger aux émaux céramiques.

Wir sind zu 100% italienisch: in Bezug auf unsere Leidenschaft, unseren Einfallsreichtum, unsere Innovationsfähigkeit und unsere Qualität. Wir produzieren zu 100% in Italien und nutzen das für unsere Orte typische handwerkliche Geschick, um unserem Industrieprodukt einen Mehrwert zu verleihen.

Diese Philosophie hat langjährig bewährte Kollektionen hervorgebracht, wie die von der Designerin Laura Biagiotti in den frühen 1980er Jahren, als die handwerkliche Technik des „colaggio“ (Guss) in der Fabrik eingeführt wurde, um spezielle, vollständig handgefertigte Stücke wie Kapitelle und Photophore herzustellen, die die industriellen Fliesenkollektionen ergänzen, um wirklich einzigartige und unnachahmliche Räume zu schaffen. Oder Fucina, eine weitere ikonische Kollektion, die 2006 den Markt aufgrund ihrer starken Ähnlichkeit mit „Metall“ verblüffte, die durch die erstmalige Verwendung von echtem Metallpulver ermöglicht wurde, das mit den Keramikglasuren gemischt wird.



Gruppo Dafin

THE DAFIN GROUP
GROUPE DAFIN
DAFIN-GRUPPE



Innovazione, dedizione, identità familiare, determinazione, legame col territorio: sono alcuni dei valori che caratterizzano il Gruppo Dafin S.p.A., società della famiglia D'Agostino da anni attiva in Italia e all'estero con marchi di rilevanza internazionale, nel settore ceramico ed in quello dei laterizi.

Innovation, dedication, family identity, determination, bond with the territory: these are some of the values that characterise the Dafin S.p.A. Group, a company of the D'Agostino family that has been active for years in Italy and abroad with brands of international importance, in the ceramic and brick sector.

Innovation, implication, identité familiale, détermination, lien avec le territoire : ce sont-là certaines des valeurs qui caractérisent le Groupe Dafin S.p.A., une société de la famille D'Agostino active depuis des années en Italie et à l'étranger avec des marques de renommée internationale, dans le secteur de la céramique et dans celui des briques.

Innovation, Hingabe, Familienidentität, Entschlossenheit, Verbundenheit mit der Region: Das sind einige der Werte, die die Gruppe Dafin S.p.A. kennzeichnen, ein Unternehmen im Besitz der Familie D'Agostino, das seit Jahren in Italien und im Ausland mit international bekannten Marken im Keramik- und Ziegelsektor tätig ist.



Tra le aziende del Gruppo spicca IBL SpA, acquisita nel 1996 e fondata nel 1964 a Bentivoglio come "Industria Bolognese Laterizi"; un'importante realtà produttiva che offre una gamma completa di prodotti in laterizio, a copertura di tutte le esigenze costruttive degli edifici.

Among the companies of the Group IBL SpA stands out, acquired in 1996 and founded in 1964 in Bentivoglio as "Industria Bolognese Laterizi"; an important production company that offers a complete range of brick products, to cover all the construction needs of buildings.

Parmi les entreprises du Groupe se démarque IBL SpA, achetée en 1996 et fondée en 1964 à Bentivoglio comme « Industria Bolognese Laterizi » ; un fabricant important qui offre une gamme complète de produits en brique, pour couvrir tous les besoins de construction des bâtiments.

Zu den wichtigsten Unternehmen der Gruppe zählt die 1996 erworbene IBL SpA, die 1964 in Bentivoglio als „Industria Bolognese Laterizi“ gegründet wurde und ein umfassendes Sortiment an Ziegelprodukten für den gesamten Baubedarf anbietet.

STABILIMENTI DI PRODUZIONE DAFIN DAFIN PRODUCTION FACILITIES USINES DE PRODUCTION DAFIN PRODUKTIONSSTÄTTEN DAFIN

Castel Bolognese (RA)



Cotignola (RA)



Bentivoglio (BO)



Bagnara di Romagna (RA)



Bagnara di Romagna (RA)



Bagnara di Romagna (RA)

STONE & CLASSIC



Tavola sinottica delle collezioni

Product recap by look, colour and thickness.
Tableau synoptique des collections.
Übersichtstafel.

COLORI FREDDI 24

COOL COLOURS.
COULEURS FROIDES.
KALTE FARBEN.

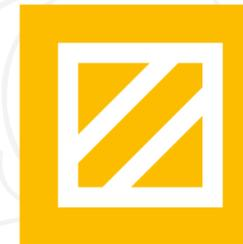
COLORI CALDI 26

WARM COLOURS.
COULEURS CHAUDES.
WARME FARBEN.

PIETRA D'ORVIETO 28

MEDITERRANEA 64

NAMUR 90

ILCOTTOTAGINA 108

UMBRIA ANTICA 126

PIETRA REGALE 140

DEEP BLUE 156

AURUM STONE 162

TAVOLA SINOTTICA DELLE COLLEZIONI

Product recap by look, colour and thickness . Tableau synoptique des collections . Übersichtstafel.

COLORI FREDDI

Cool colours . Couleurs froides . Kalte Farben.

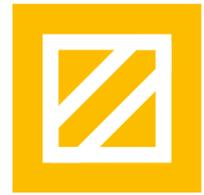

Naturale e rettificato.
Natural rectified.
Naturel et rectifié.
Natur Oberfläche und rektifiziert.

Naturale e naturale.
Natural and natural.
Naturel et naturel.
Natur natur.

Bocciardato rettificato.
Bush-hammered rectified.
Bouchardé rectifié.
Gehämmert und rektifiziert.

Lucidato e rettificato.
Glossy rectified.
Brillant et rectifié.
Glossy/Shiny und rektifiziert.

Velvet rettificato.
Velvet rectified.
Velvet rectifié.
Velvet rektifiziert.

		BIANCO PIETRA D'ORVIETO PAG. 28	CENDRE NAMUR PAG. 90	OSTANA PIETRA REGALE PAG. 140	GRIGIO DEEP BLUE PAG. 156	CHIANALE PIETRA REGALE PAG. 140	MURAZZANO PIETRA REGALE PAG. 140	MENFI MEDITERRANEA PAG. 64	ANTRACITE UMBRIA ANTICA PAG. 126	ANTRACITE DEEP BLUE PAG. 156	FONCÉ NAMUR PAG. 90	
I N D O O R	6 mm	120x280 48"x110"										
		120x120 48"x48"	Nat. - Bocciardato Velvet									
		80x80 31 1/2"x31 1/2"	Nat. - Bocciardato									
	9 mm	60x120 24"x48"	Nat. - Bocciardato Lucidato - Velvet									
		60x60 24"x24"	Nat. - Bocciardato Lucidato - Velvet									
		30x60 12"x24"	Nat. - Bocciardato Lucidato - Velvet									
		10x30 4"x12"	Nat. - Bocciardato Lucidato - Velvet									
		90x90 35 1/2"x35 1/2"		<input type="checkbox"/> Nat. Ret.	<input type="checkbox"/> Nat. Ret.		<input type="checkbox"/> Nat. Ret.	<input type="checkbox"/> Nat. Ret.	<input type="checkbox"/> Nat. Ret.	<input type="checkbox"/> Nat. Ret.		<input type="checkbox"/> Nat. Ret.
		60x90 24"x35 1/2"		<input type="checkbox"/> Nat. Ret.				<input type="checkbox"/> Nat. Ret.				<input type="checkbox"/> Nat. Ret.
	10 mm	45x90 18"x35 1/2"			<input type="checkbox"/> Nat. Ret.		<input type="checkbox"/> Nat. Ret.			<input type="checkbox"/> Nat. Ret.		
		60x120 24"x48"			<input type="checkbox"/> Nat. Ret.		<input type="checkbox"/> Nat. Ret.			<input type="checkbox"/> Nat. Ret.		
		60x60 24"x24"		<input type="checkbox"/> Nat. Ret.	<input type="checkbox"/> Nat. Ret.		<input type="checkbox"/> Nat. Ret.		<input type="checkbox"/> Nat. Ret.	<input type="checkbox"/> Nat. Ret.		<input type="checkbox"/> Nat. Ret.
40x60 16"x24"							<input type="checkbox"/> Nat. Ret.					
30,2x60,4 12"x24"												
30x60 12"x24"				<input type="checkbox"/> Nat. Ret.		<input type="checkbox"/> Nat. Ret.	<input type="checkbox"/> Nat. Ret.	<input type="checkbox"/> Nat. Ret.	<input type="checkbox"/> Nat. Ret.			
40x40 16"x16"							<input type="checkbox"/> Nat. Ret.					
20x40 8"x16"							<input type="checkbox"/> Nat. Ret.					
25x22 Esagono 10"x8 1/2"			<input checked="" type="checkbox"/> Nat. Nat.								<input checked="" type="checkbox"/> Nat. Nat.	
20x20 8"x8"							<input type="checkbox"/> Nat. Ret.					
I N D O O R	9 mm	120x120 48"x48"	<input type="checkbox"/> Nat. Ret.									
		60x120 24"x48"	<input type="checkbox"/> Nat. Ret.									
		30,2x60,4 12"x24"			<input checked="" type="checkbox"/> Nat. Nat. R11		<input checked="" type="checkbox"/> Nat. Nat. R11	<input checked="" type="checkbox"/> Nat. Nat. R11		<input checked="" type="checkbox"/> Nat. Nat. R11		
	10 mm	90x90 35 1/2"x35 1/2"										
		60x90 24"x35 1/2"						<input type="checkbox"/> Nat. Ret. R11				
		45x90 18"x35 1/2"			<input type="checkbox"/> Nat. Ret. R11		<input type="checkbox"/> Nat. Ret. R11	<input type="checkbox"/> Nat. Ret. R11		<input type="checkbox"/> Nat. Ret. R11		
		40x60 16"x24"						<input type="checkbox"/> Nat. Ret. R11				
		40x40 16"x16"						<input type="checkbox"/> Nat. Ret. R11				
		20x40 8"x16"						<input type="checkbox"/> Nat. Ret. R11				
	20x20 8"x8"						<input type="checkbox"/> Nat. Ret. R11					
	20 mm	120x120 48"x48"	<input type="checkbox"/> Nat. Ret.			<input type="checkbox"/> Nat. Ret. R11					<input type="checkbox"/> Nat. Ret. R11	
		90x90 35 1/2"x35 1/2"		<input type="checkbox"/> Nat. Ret.	<input type="checkbox"/> Nat. Ret. R11	<input type="checkbox"/> Nat. Ret. R11	<input type="checkbox"/> Nat. Ret. R11	<input type="checkbox"/> Nat. Ret. R11	<input type="checkbox"/> Nat. Ret. R11	<input type="checkbox"/> Nat. Ret. R11	<input type="checkbox"/> Nat. Ret. R11	<input type="checkbox"/> Nat. Ret.
60x120 24"x48"		<input type="checkbox"/> Nat. Ret.		<input type="checkbox"/> Nat. Ret. R11		<input type="checkbox"/> Nat. Ret. R11			<input type="checkbox"/> Nat. Ret. R11			
80x80 31 1/2"x31 1/2"		<input type="checkbox"/> Nat. Ret.										
60x90 24"x35 1/2"			<input type="checkbox"/> Nat. Ret.					<input type="checkbox"/> Nat. Ret. R11			<input type="checkbox"/> Nat. Ret.	
60x60 24"x24"			<input type="checkbox"/> Nat. Ret.	<input type="checkbox"/> Nat. Ret. R11	<input type="checkbox"/> Nat. Ret. R11	<input type="checkbox"/> Nat. Ret. R11	<input type="checkbox"/> Nat. Ret. R11		<input type="checkbox"/> Nat. Ret. R11	<input type="checkbox"/> Nat. Ret. R11	<input type="checkbox"/> Nat. Ret.	
30 mm	90x90 35 1/2"x35 1/2"			<input type="checkbox"/> Nat. Ret. R11	<input type="checkbox"/> Nat. Ret. R11	<input type="checkbox"/> Nat. Ret. R11			<input type="checkbox"/> Nat. Ret. R11			
	60x60 24"x24"			<input type="checkbox"/> Nat. Ret. R11	<input type="checkbox"/> Nat. Ret. R11	<input type="checkbox"/> Nat. Ret. R11			<input type="checkbox"/> Nat. Ret. R11			

TAVOLA SINOTTICA DELLE COLLEZIONI

Product recap by look, colour and thickness . Tableau synoptique des collections . Übersichtstafel.

COLORI CALDI

Warm colours . Couleurs chaudes . Warme Farben.

□ Naturale e rettificato.
Natural rectified.
Naturel et rectifié.
Natur Oberfläche und rektifiziert.

■ Naturale e naturale.
Natural and natural.
Naturel et naturel.
Natur natur.

○ Bocciardato rettificato.
Bush-hammered rectified.
Bouchardé rectifié.
Gehämmert und rektifiziert.

○ Lucidato e rettificato.
Glossy rectified.
Brillant et rectifié.
Glossy/Shiny und rektifiziert.

◇ Velvet rettificato.
Velvet rectified.
Velvet rectifié.
Velvet rektifiziert.



		BEIGE PIETRA D'ORVIETO PAG. 28	BLANCHE NAMUR PAG. 90	DOR MEDITERRANEA PAG. 64	PURE AURUM STONE PAG. 162	ELVA PIETRA REGALE PAG. 140	BYBLOS MEDITERRANEA PAG. 64	RIVOLI PIETRA REGALE PAG. 140	CENERE PIETRA D'ORVIETO PAG. 28	SABBIA PIETRA D'ORVIETO PAG. 28	GRIGIO UMBRIA ANTICA PAG. 126	ERICE MEDITERRANEA PAG. 64	BIANCO UMBRIA ANTICA PAG. 126	GREY ILCOTTOTAGINA PAG. 108	CLEAR ILCOTTOTAGINA PAG. 108	NATURAL ILCOTTOTAGINA PAG. 108	RED ILCOTTOTAGINA PAG. 108	
R	6 mm	120x280 48"x110"							Nat. - Bocciardato Velvet	Nat. - Bocciardato Velvet								
		120x120 48"x48"								Nat. - Bocciardato	Nat. - Bocciardato							
		80x80 31 1/2"x31 1/2"								Nat. - Bocciardato	Nat. - Bocciardato							
	9 mm	60x120 24"x48"				□ Nat. Ret.				Nat. - Bocciardato Lucidato - Velvet	Nat. - Bocciardato Lucidato - Velvet							
		60x60 24"x24"				□ Nat. Ret.				Nat. - Bocciardato Lucidato - Velvet	Nat. - Bocciardato Lucidato - Velvet							
		30,2x60,4 12"x24"				■ Nat. Nat.												
		30x60 12"x24"				□ Nat. Ret.				Nat. - Bocciardato Lucidato - Velvet	Nat. - Bocciardato Lucidato - Velvet							
		10x30 4"x12"								Nat. - Bocciardato Lucidato - Velvet	Nat. - Bocciardato Lucidato - Velvet							
		90x90 35 1/2"x35 1/2"		□ Nat. Ret.	□ Nat. Ret.		□ Nat. Ret.	□ Nat. Ret.	□ Nat. Ret.			□ Nat. Ret.	□ Nat. Ret.	□ Nat. Ret.	□ Nat. Ret.	□ Nat. Ret.	□ Nat. Ret.	□ Nat. Ret.
	10 mm	60x90 24"x35 1/2"		□ Nat. Ret.	□ Nat. Ret.				□ Nat. Ret.			□ Nat. Ret.						
		45x90 18"x35 1/2"					□ Nat. Ret.		□ Nat. Ret.		□ Nat. Ret.		□ Nat. Ret.					
		60x120 24"x48"					□ Nat. Ret.		□ Nat. Ret.		□ Nat. Ret.		□ Nat. Ret.					
60x60 24"x24"			□ Nat. Ret.	□ Nat. Ret.		□ Nat. Ret.	□ Nat. Ret.	□ Nat. Ret.		□ Nat. Ret.	□ Nat. Ret.	□ Nat. Ret.	□ Nat. Ret.	□ Nat. Ret.	□ Nat. Ret.	□ Nat. Ret.	□ Nat. Ret.	
40x60 16"x24"				□ Nat. Ret.			□ Nat. Ret.				□ Nat. Ret.							
30,2x60,4 12"x24"																		
30x60 12"x24"				□ Nat. Ret.		□ Nat. Ret.	□ Nat. Ret.	□ Nat. Ret.		□ Nat. Ret.	□ Nat. Ret.	□ Nat. Ret.	□ Nat. Ret.	□ Nat. Ret.	□ Nat. Ret.	□ Nat. Ret.	□ Nat. Ret.	
40x40 16"x16"				□ Nat. Ret.			□ Nat. Ret.				□ Nat. Ret.							
20x40 8"x16"				□ Nat. Ret.			□ Nat. Ret.				□ Nat. Ret.							
25x22 Esagono 10"x8 1/2"			■ Nat. Nat.															
20x20 8"x8"			□ Nat. Ret.				□ Nat. Ret.				□ Nat. Ret.							
O	9 mm	120x120 48"x48"	□ Nat. Ret.						□ Nat. Ret.	□ Nat. Ret.								
		60x120 24"x48"	□ Nat. Ret.						□ Nat. Ret.	□ Nat. Ret.								
		30,2x60,4 12"x24"					■ Nat. Nat. R11		■ Nat. Nat. R11		■ Nat. Nat. R11		■ Nat. Nat. R11					
	10 mm	90x90 35 1/2"x35 1/2"												□ Nat. Ret. R11	□ Nat. Ret. R11	□ Nat. Ret. R11	□ Nat. Ret. R11	
		60x90 24"x35 1/2"			□ Nat. Ret. R11			□ Nat. Ret. R11				□ Nat. Ret. R11						
		45x90 18"x35 1/2"					□ Nat. Ret. R11		□ Nat. Ret. R11		□ Nat. Ret. R11		□ Nat. Ret. R11					
		40x60 16"x24"			□ Nat. Ret. R11			□ Nat. Ret. R11				□ Nat. Ret. R11						
		40x40 16"x16"			□ Nat. Ret. R11			□ Nat. Ret. R11				□ Nat. Ret. R11						
		20x40 8"x16"			□ Nat. Ret. R11			□ Nat. Ret. R11				□ Nat. Ret. R11						
	20x20 8"x8"			□ Nat. Ret. R11			□ Nat. Ret. R11				□ Nat. Ret. R11							
	20 mm	120x120 48"x48"	□ Nat. Ret.						□ Nat. Ret.	□ Nat. Ret.								
		90x90 35 1/2"x35 1/2"		□ Nat. Ret.	□ Nat. Ret. R11		□ Nat. Ret. R11	□ Nat. Ret. R11	□ Nat. Ret. R11		□ Nat. Ret. R11	□ Nat. Ret. R11	□ Nat. Ret. R11	□ Nat. Ret. R11	□ Nat. Ret. R11	□ Nat. Ret. R11	□ Nat. Ret. R11	
60x120 24"x48"		□ Nat. Ret.				□ Nat. Ret. R11		□ Nat. Ret. R11	□ Nat. Ret.	□ Nat. Ret.		□ Nat. Ret. R11						
80x80 31 1/2"x31 1/2"		□ Nat. Ret.						□ Nat. Ret.	□ Nat. Ret.									
60x90 24"x35 1/2"			□ Nat. Ret.	□ Nat. Ret. R11			□ Nat. Ret. R11				□ Nat. Ret. R11							
60x60 24"x24"			□ Nat. Ret.		□ Nat. Ret. R11	□ Nat. Ret. R11		□ Nat. Ret. R11		□ Nat. Ret. R11		□ Nat. Ret. R11	□ Nat. Ret. R11	□ Nat. Ret. R11	□ Nat. Ret. R11	□ Nat. Ret. R11		
30 mm	90x90 35 1/2"x35 1/2"				-			□ Nat. Ret. R11		□ Nat. Ret. R11		□ Nat. Ret. R11	□ Nat. Ret. R11	□ Nat. Ret. R11	□ Nat. Ret. R11	-		
	60x60 24"x24"				-			□ Nat. Ret. R11		□ Nat. Ret. R11		□ Nat. Ret. R11	□ Nat. Ret. R11	□ Nat. Ret. R11	□ Nat. Ret. R11	-		

PIETRA D'ORVIETO

PIETRA D'ORVIETO si ispira ad una particolare roccia carbonatica estratta in centro Italia, nei pressi della omonima città. Se la ricercata grafica, delicata nei tratti e contraddistinta da leggere striature di colore bruno la rendono icona di eleganza nonché poliedrica nello stile, le 5 finiture superficiali indoor/outdoor la elevano a vera collezione di eccellenza grazie soprattutto alle versioni velvet e naturale dove, sfruttando l'innovativa tecnologia "Realistic 3D vein effect", gli avvallamenti delle vene in superficie coincidono con la texture della grafica sottostante per un effetto estetico e tattile davvero realistico al pari della pietra naturale di cava.

PIETRA D'ORVIETO is inspired by a particular carbonate rock extracted in central Italy, near the city of the same name. Its refined design, characterised by delicate features and marked by light streaks of dark brown, makes it an icon of elegance as well as multifaceted in style. The 5 indoor/outdoor surface finishes elevate it to a true collection of excellence thanks above all to the velvet and natural versions, where, through the innovative 'Realistic 3D vein effect' technology, the grooves of the veins on the surface coincide with the texture of the underlying design for a truly realistic aesthetic and tactile effect on par with natural quarry stone.

PIETRA D'ORVIETO s'inspire d'une roche carbonatée particulière extraite dans le centre de l'Italie, près de la ville du même nom. Si le graphisme raffiné, aux lignes délicates, strié de légers filets bruns en fait une icône d'élégance au style multiforme, les 5 finitions de surface intérieur/extérieur l'élèvent au rang d'excellence grâce surtout aux versions velvet et naturelle où, par la technologie innovante « Realistic 3D vein effect », les dépressions des veines en surface coïncident avec la texture des graphiques sous-jacents pour un effet esthétique et tactile vraiment réaliste digne de la pierre de carrière naturelle.

PIETRA D'ORVIETO ist von einem bestimmten Karbonatgestein inspiriert, das in Mittelitalien in der Nähe der gleichnamigen Stadt abgebaut wird. Das raffinierte grafische Design mit seinen zarten Linien und hellbraunen Schlieren macht ihn zu einer Ikone der Eleganz und des vielseitigen Stils. Die 5 Oberflächenausführungen für den Innen- und Außenbereich machen ihn zu einer echten Spitzenkollektion, vor allem dank den velvet und natürlichen Versionen, bei der die Vertiefungen der Adern auf der Oberfläche dank der innovativen Technologie "Realistic 3D vein effect" mit der Textur des zugrunde liegenden grafischen Designs übereinstimmen und so einen wahrhaft realistischen ästhetischen und taktilen Effekt erzielen, der dem von natürlichem Bruchstein gleichkommt.

100% Made in Italy



RIVESTIMENTO - WALL
Collection CALACATTA GOLD 120x280 Nat. Ret.

PAVIMENTO - FLOOR
BEIGE 120x280 Nat. Ret.



RIVESTIMENTO . WALL
Collection CALACATTA GOLD 120x280 Lucidato Ret.

PAVIMENTO . FLOOR
BEIGE 60x60 Lucidato Ret.
BEIGE 30x60 Lucidato Ret.



RIVESTIMENTO . WALL
CENERE Decoro Stripes

RIVESTIMENTO CUCINA . KITCHEN BACKSPASH
CENERE Mosaico Blended 30x30 Ret.

PAVIMENTO . FLOOR
BIANCO 120x120 Nat. Ret.



BIANCO 120x120 20 mm Nat. Ret. R11
BIANCO Elemento a L 33x120x4h 20 mm Nat Ret. R11
Special pieces for swimming pool:
BIANCO Griglia + Ang. 20x60 20 mm Nat. Ret. R11
BIANCO Gradone grip bordo piscina + Ang. 30x120 20 mm Nat. Ret. R11
PARETE . FAÇADE: CENERE 120x280 Nat. Ret.



BIANCO 120x120 Velvet Ret.



RIVESTIMENTO . WALL
CENERE 120x280 Nat. Ret.

PAVIMENTO . FLOOR
CENERE 80x80 Nat. Ret.



CENERE 60x120 Lucidato Ret.
CENERE Gradino a C 33x120x3,2 Lucidato Ret.





RIVESTIMENTO . WALL
SABBIA 60x120 Bocciardato Ret.

PAVIMENTO . FLOOR
SABBIA 60x60 Nat. Ret.

BELVEDERE *****
Hotel & Resort

RIVESTIMENTO . WALL
SABBIA 120x280 Nat. Ret.

BANCONE . COUNTER
BEIGE 6mm Nat. Ret.

PAVIMENTO . FLOOR
SABBIA 80x80 Velvet Ret.
GEOMETRIC SABBIA Velvet Ret.



SABBIA 60x120 20 mm Nat. Ret. R11

Special pieces for swimming pool:
SABBIA Gradone grip bordo piscina + Ang. 30x120 20 mm Nat. Ret. R11
SABBIA Griglia + Ang. 20x60 20 mm Nat. Ret. R11

GAMMA DELLA COLLEZIONE
Collection range / Gamme de la collection / Sortiment der Kollektion

COLORI
COLOURS
COULEURS
FARBEN

APPLICAZIONI
APPLICATIONS
APPLICATIONS
ANWENDUNGEN

SPESSORE
THICKNESS
EPAISSEUR
STÄRKE

SUPERFICIE
SURFACE
SURFACE
OBERFLÄCHE

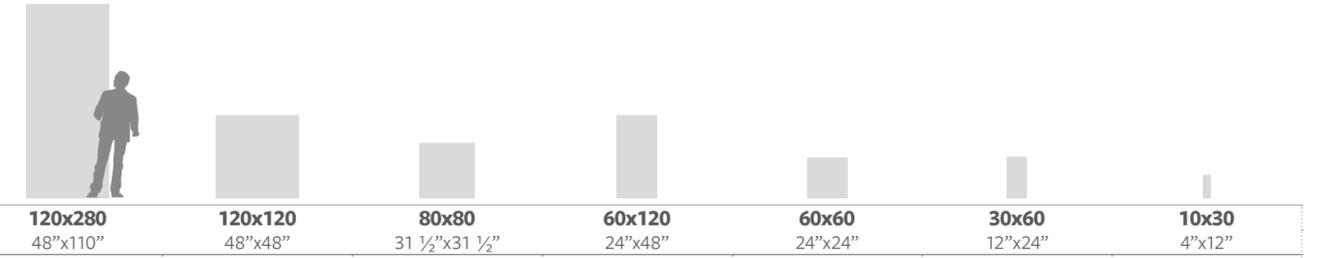

Color	Application	Thickness	Surface	120x280 48"x110"	120x120 48"x48"	80x80 31 1/2"x31 1/2"	60x120 24"x48"	60x60 24"x24"	30x60 12"x24"	10x30 4"x12"
BIANCO	INDOOR	6 mm	□ Nat. Ret.	●						
			○ Bocciardato Ret.	●						
◇ Velvet Ret.			●							
9 mm		□ Nat. Ret.		●	●	●	●	●	●	
		○ Bocciardato Ret.				●	●	●	●	
		○ Lucidato Ret.				●	●	●	●	
BEIGE	9 mm	◇ Velvet Ret.		●	●	●	●	●	●	
		OUTDOOR	9 mm	□ Nat. Ret. R11		●	●			
				20 mm		●	●	●		

● **Realistic 3D vein effect**

NATURALEZZA SOPRENDENTE
Grazie all'innovativa tecnologia "Realistic 3D vein effect", che fa coincidere perfettamente le vene alla struttura della piastrella, le finiture Velvet e Naturale restituiscono una sorprendente sensazione tattile e visiva della superficie ceramica. Un effetto tanto realistico quanto affascinante al tocco e allo sguardo.

SURPRISING NATURALNESS
Thanks to the innovative 'Realistic 3D vein effect' technology, which makes the veins coincide perfectly with the structure of the tile, the Velvet and Natural finishes give a surprising tactile and visual sensation to the ceramic surface. An effect that is as realistic as it is fascinating to touch and see.

UN NATUREL SURPRENANT
Grâce à la technologie innovante « Realistic 3D vein effect », qui fait coïncider parfaitement les veines avec la structure du carreau, les finitions Velvet et Naturelle restituent à la surface de la céramique une sensation tactile et visuelle surprenante. Un effet aussi réaliste que fascinant au toucher et à l'œil.

ERSTAUNLICHE NATÜRLICHKEIT
Dank der innovativen Technologie "Realistic 3D-Vein-Effect", die die Adern perfekt an die Struktur der Fliese anpasst, bieten die Velvet und Natürlichen Finishes ein erstaunliches taktiles und visuelles Gefühl der Keramikoberfläche. Ein ebenso realistischer wie faszinierender Effekt für Auge und Haptik.



PIETRA D'ORVIETO

SUPERFICI

Surfaces / Surfaces / Oberflächen

Naturale e rettificato.
Natural rectified.
Naturel et rectifié.
Natur Oberfläche und rektifiziert.

Velvet rettificato.
Velvet rectified.
Velvet rectifié.
Velvet rektifiziert.

Lucidato e rettificato.
Glossy Rectified.
Brillant et rectifié.
Glossy/Shiny und rektifiziert.

BEIGE

Bocciardato rettificato.
Bush-hammered rectified.
Bouchardé rectifié.
Gehämmert rektifiziert.

BEIGE

PIETRA D'ORVIETO

FORMATI

Sizes / Formats / Formate

- 6 mm . 120x280 - 48"x110"**
- 9 mm . 120x120 - 48"x48" / 60x120 - 24"x48" / 80x80 - 31 1/2"x31 1/2" / 60x60 - 24"x24" / 30x60 - 12"x24" / 10x30 - 4"x12"**
- 9 mm R11 . 120x120 - 48"x48" / 60x120 - 24"x48"**
- 20 mm R11 . 120x120 - 48"x48" / 60x120 - 24"x48" / 80x80 - 31 1/2"x31 1/2"**

COLORI

Colours / Couleurs / Farben

BIANCO



- Naturale e rettificato.**
Natural rectified.
Naturel et rectifié.
Natur Oberfläche und rektifiziert.
- Velvet rettificato.**
Velvet rectified.
Velvet rectifié.
Velvet rektifiziert.
- Lucidato e rettificato.**
Glossy rectified.
Brillant et rectifié.
Glossy/Shiny und rektifiziert.

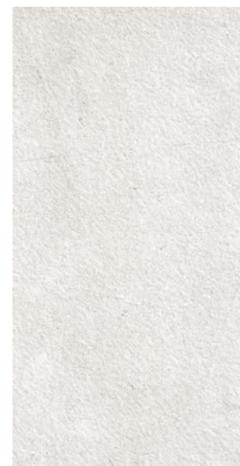

- Bocciardato rettificato.**
Bush-hammered rectified.
Bouchardé rectifié.
Gehämmert rektifiziert.

CENERE



- Naturale e rettificato.**
Natural rectified.
Naturel et rectifié.
Natur Oberfläche und rektifiziert.
- Velvet rettificato.**
Velvet rectified.
Velvet rectifié.
Velvet rektifiziert.
- Lucidato e rettificato.**
Glossy rectified.
Brillant et rectifié.
Glossy/Shiny und rektifiziert.



- Bocciardato rettificato.**
Bush-hammered rectified.
Bouchardé rectifié.
Gehämmert rektifiziert.

BEIGE



- Naturale e rettificato.**
Natural rectified.
Naturel et rectifié.
Natur Oberfläche und rektifiziert.
- Velvet rettificato.**
Velvet rectified.
Velvet rectifié.
Velvet rektifiziert.
- Lucidato e rettificato.**
Glossy rectified.
Brillant et rectifié.
Glossy/Shiny und rektifiziert.



- Bocciardato rettificato.**
Bush-hammered rectified.
Bouchardé rectifié.
Gehämmert rektifiziert.

SABBIA



- Naturale e rettificato.**
Natural rectified.
Naturel et rectifié.
Natur Oberfläche und rektifiziert.
- Velvet rettificato.**
Velvet rectified.
Velvet rectifié.
Velvet rektifiziert.
- Lucidato e rettificato.**
Glossy rectified.
Brillant et rectifié.
Glossy/Shiny und rektifiziert.



- Bocciardato rettificato.**
Bush-hammered rectified.
Bouchardé rectifié.
Gehämmert rektifiziert.

CONTINUITÀ PROGETTUALE INDOOR-OUTDOOR

Design continuity indoors and out / Continuité conceptuelle à l'intérieur et à l'extérieur / Entwurfskontinuität im innen-und Aussenbereich



INDOOR

Soluzioni contemporanee per l'interior design
Contemporary solutions for interior design.
Solutions contemporaines pour le design intérieur.
Zeitgemäße Lösungen für das Interior Design.

OUTDOOR

Versatilità e prestazioni per la progettazione in esterna
Versatility and performance for outdoor design.
Polyvalence et performance pour l'aménagement extérieur.
Vielseitigkeit und Leistungen für Outdoor-Design.

SISTEMI DI POSA

Laying systems / Systemes de pose / Verlegearten

Posa su erba

Laying on grass
Pose sur l'herbe
Verlegung auf Wiese



Posa su sabbia

Laying on sand
Pose sur sable
Verlegung auf Sand



Posa sopraelevata

Raised laying
Pose surélevée
Verlegung auf Stützlagern



Posa su ghiaia

Laying on gravel
Pose sur gravier
Verlegung auf Kies



Posa tradizionale

Standard laying
Pose traditionnelle
Herkömmliche Verlegung



Spessore . Thickness . Epaisseur . Stärke - 9 mm

Gres porcellanato colorato in massa. Full-body coloured porcelain stoneware. Grès cérame coloré dans la masse. In der Masse gefärbtes Feinsteinzeug.

DECORI

Decors / Décors / Dekore

BRAID

60x120 . 24"x48"

BIANCO



CENERE



BEIGE



SABBIA



TEXARTS

60x120 . 24"x48"

BIANCO



CENERE



BEIGE



SABBIA



MOSAICO 5x5

30x30 . 12"x12"

BIANCO



Naturale



Velvet



Lucidato

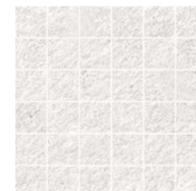

Bocciardato

CENERE



Naturale



Velvet



Lucidato



Bocciardato

BEIGE



Naturale



Velvet



Lucidato



Bocciardato

SABBIA



Naturale



Velvet



Lucidato



Bocciardato

I mosaici "Blended" sono composti da un mix di tessere nelle 4 finiture disposte in modo casuale.
The Blended mosaics are composed of a mix of tiles in the 4 finishes arranged randomly.
Les mosaïques Blended sont composées d'un mélange de carreaux dans les 4 finitions disposées au hasard.
Die Blended-Mosaik bestehen aus einem Kachelmix in 4 Ausführungen, die auf zufällige Art und Weise angeordnet sind.

MOSAICO 5x5 BLENDED 30x30 . 12"x12"

BIANCO



CENERE



BEIGE



SABBIA



MOSAICO ESAGONA 28x29 . 11"x11 1/2"

BIANCO



CENERE



BEIGE



SABBIA



STONE & CLASSIC
COLLECTION
PIETRA D'ORVIETO**Spessore** . Thickness . Epaisseur . Stärke - 9 mm**Gres porcellanato colorato in massa**. Full-body coloured porcelain stoneware. Grès cérame coloré dans la masse. In der Masse gefärbtes Feinsteinzeug.**DECORI**

Decors / Décors / Dekore

GEOMETRIC**STRIPES****STRIPES: La scatola contiene 1 pezzo per formato, non su rete, nella finitura come illustrato nel dettaglio.**

STRIPES: The box contains 1 piece per size, not on grid (loose), in the finish as shown in the detail sheet.

STRIPES: La boîte contient 1 pièce par format, pas sur filet, dans la finition comme illustré dans le détail.

STRIPES: Die Box enthält 1 Stück pro Format, nicht auf Netz, in der Ausführung wie im Detail abgebildet.

OPTICAL**OPTICAL: I rombi e i quadrati che compongono il decoro sono forniti nella finitura come illustrato nel dettaglio.**

OPTICAL: The rhombuses and squares that make up the decor are supplied in the finish as shown in the detail sheet.

OPTICAL: Les losanges et les carrés qui composent le décor sont fournis dans la finition comme illustré dans le détail.

OPTICAL: Die Rauten und Quadrate, aus denen sich das Dekor zusammensetzt, werden in der Ausführung geliefert, wie im Detail abgebildet.

RIVESTIMENTO . WALL
CENERE Decoro Stripes Ret.PAVIMENTO . FLOOR
BIANCO 120x120 Nat. Ret.

PIETRA D'ORVIETO

Spessore . Thickness . Epaisseur . Stärke - **9 mm**

Gres porcellanato colorato in massa. Full-body coloured porcelain stoneware. Grès cérame coloré dans la masse. In der Masse gefärbtes Feinsteinzeug.

DECORI

Decors / Décors / Dekore



Braid
60x120
24"x48"



Texarts
60x120
24"x48"

Geometric

Stripes



Optical



Mosaico (5x5)
30x30
12"x12"



Mosaico (5x5) Blended
30x30
12"x12"



Mosaico Esagona Blended
28x29
11"x11 1/2"

SPESSORE - THICKNESS - EPAISSEUR - STÄRKE		9 mm	9 mm	9 mm	9 mm	9 mm	9 mm	9 mm
	□ Nat. Ret.	138358	138362	138334			138300	
	○ Bocciardato Ret.	-	-	138335	138330	138354	138301	138320
	○ Lucidato Ret.	-	-	138336			138302	138324
	◇ Velvet Ret.	-	-	138337			138303	
	□ Nat. Ret.	138359	138363	138338			138304	
	○ Bocciardato Ret.	-	-	138339	138331	138355	138305	138321
	○ Lucidato Ret.	-	-	138340			138306	138325
	◇ Velvet Ret.	-	-	138341			138307	
	□ Nat. Ret.	138360	138364	138342			138308	
	○ Bocciardato Ret.	-	-	138343	138332	138356	138309	138322
	○ Lucidato Ret.	-	-	138344			138310	138326
	◇ Velvet Ret.	-	-	138345			138311	
	□ Nat. Ret.	138361	138365	138350			138312	
	○ Bocciardato Ret.	-	-	138351	138333	138357	138313	138323
	○ Lucidato Ret.	-	-	138352			138314	138327
	◇ Velvet Ret.	-	-	138353			138315	



RIVESTIMENTO CUCINA . KITCHEN BACKSPLASH
CENERE Mosaico Blended 30x30 Ret.

□ Naturale e rettificato.
Natural rectified.
Naturel et rectifié.
Natur Oberfläche und rektifiziert.

○ Bocciardato rettificato.
Bush-hammered rectified.
Bouchardé rectifié.
Gehämmert und rektifiziert.

○ Lucidato e rettificato.
Glossy rectified.
Brillant et rectifié.
Glossy/Shiny und rektifiziert.

◇ Velvet rettificato.
Velvet rectified.
Velvet rectifié.
Velvet rektifiziert.

PIETRA D'ORVIETO

Spessore . Thickness . Epaisseur . Stärke - 6 mm

Lastre in gres porcellanato pressate a secco . Dry-pressed porcelain stoneware slabs . Dalles en grès cérame pressées à sec . Trocken gepresste Platten aus Feinsteinzeug.

Spessore . Thickness . Epaisseur . Stärke - 9 mm

Gres porcellanato colorato in massa . Full-body coloured porcelain stoneware . Grès cérame coloré dans la masse . In der Masse gefärbtes Feinsteinzeug.

INDOOR

TABELLA RIEPILOGATIVA
Summary table
Tableau récapitulatif
Zusammenfassende Tabelle

		120x280 48"x110"	120x120 48"x48"	80x80 31 1/2"x31 1/2"	60x120 24"x48"	60x60 24"x24"	30x60 12"x24"	10x30 4"x12"	Mosaico (5x5) 30x30 12"x12"	Mosaico (5x5) Blended 30x30 12"x12"	Mosaico Esagono Blended 28x29 11"x11 1/2"	*** Coprispigolo triangolare 0,8x120 1/2"x48"	1,4x120 1/2"x48"	Ang. Coprispigolo triang. 0,8x0,8 1/2"x 1/2"	1,4x1,4 1/2"x 1/2"	Battiscopa 6,3x120 2 1/2"x48"	7,2x80 3"x31 1/2"	7,2x60 3"x24"	* Gradino a C 33x120x3,2h 13"x48"x1 1/4"h	* Ang. Gradino a C - SX 33x120x3,2h 13"x48"x1 1/4"h	* Ang. Gradino a C - DX 33x120x3,2h 13"x48"x1 1/4"h	
SPESSORE - THICKNESS - EPAISSEUR - STÄRKE		6 mm	9 mm	9 mm	9 mm	9 mm	9 mm	9 mm	9 mm	9 mm	9 mm	6 mm	9 mm	6 mm	9 mm	9 mm	9 mm	9 mm	9 mm	9 mm		
	□ Nat. Ret.	138001	138021	138017	138041	138069	138071	138091	138300			138324	138400	138420	138440	138460	138150	138166	138170	138200	138264	138232
	○ Bocciardato Ret.	138002	-	-	138042	138070	138072	138092	138301	138320			138401	138421	138441	138461	138151	-	138171	138201	138265	138233
	○ Lucidato Ret.	-	-	-	138043	138129	138073	138093	138302				-	138422	-	138462	138152	-	138172	138202	138266	138234
	◇ Velvet Ret.	138004	138024	138020	138044	138107	138074	138094	138303				138403	138423	138443	138463	138153	138169	138173	138203	138267	138235
	□ Nat. Ret.	138005	138025	138037	138045	138108	138075	138095	138304			138325	138404	138424	138444	138464	138154	138186	138174	138204	138268	138236
	○ Bocciardato Ret.	138006	-	-	138046	138109	138076	138096	138305	138321			138405	138425	138445	138465	138155	-	138175	138205	138269	138237
	○ Lucidato Ret.	-	-	-	138047	138130	138077	138097	138306				-	138426	-	138466	138156	-	138176	138206	138270	138238
	◇ Velvet Ret.	138008	138028	138040	138048	138110	138078	138098	138307				138407	138427	138447	138467	138157	138189	138177	138207	138271	138239
	□ Nat. Ret.	138009	138029	138057	138049	138119	138079	138099	138308			138326	138408	138428	138448	138468	138158	138190	138178	138208	138272	138240
	○ Bocciardato Ret.	138010	-	-	138050	138120	138080	138100	138309	138322			138409	138429	138449	138469	138159	-	138179	138209	138273	138241
	○ Lucidato Ret.	-	-	-	138051	138131	138081	138101	138310				-	138430	-	138470	138160	-	138180	138210	138274	138242
	◇ Velvet Ret.	138012	138032	138060	138052	138121	138082	138102	138311				138411	138431	138451	138471	138161	138193	138181	138211	138275	138243
	□ Nat. Ret.	138013	138033	138087	138053	138122	138083	138103	138312			136327	138412	138432	138452	138472	138162	138194	138182	138212	138276	138244
	○ Bocciardato Ret.	138014	-	-	138054	138123	138084	138104	138313	138323			138413	138433	138453	138473	138163	-	138183	138213	138277	138245
	○ Lucidato Ret.	-	-	-	138055	138132	138085	138105	138314				-	138434	-	138474	138164	-	138184	138214	138278	138246
	◇ Velvet Ret.	138016	138036	138090	138056	138124	138086	138106	138315				138415	138435	138455	138475	138165	138197	138185	138215	138279	138247
MQ x pezzo - Sqm x pcs		3,36																				
Kg x pezzo - Kg x pcs		48,6																				
IMBALLI - PACKAGING EMBALLAGE - VERPACKUNG																						
N°		20																				
m²		67,2																				
** Kg		1062																				
			2	2	2	3	6	20	11	11		11	6	6		9	8	14	2	1	1	
			2,88	1,28	1,44	1,08	1,08	0,6	0,99	0,99		0,89	1,2	1,8		14,2	8,5	10,6	21	10,5	10,5	
			58	26	29	22	22	12	19,5	19,5		17,5										
			18	40	30	40	40	72														
			51,84	51,2	43,2	43,2	43,2	43,2														
			1097	1060	890	900	900	884														
			65	95	75	75	75	73														
Imballo (tara) - Packaging (tare)		(90)	(53)	(20)	(20)	(20)	(20)	(20)	(20)	(20)	(20)	(20)	(20)	(20)	(20)	(20)	(20)	(20)	(20)	(20)	(20)	
N°		44																				
m²		147,84																				
** Kg		2259																				
Imballo (tara) - Packaging (tare)		(120)																				

I pesi riportati in tabella sono indicativi e potrebbero essere soggetti a leggere variazioni.
The weights stated in the chart may undergo slight changes for production reasons.
Les poids indiqués dans le tableau peuvent subir de légères variations pour des raisons de production.
Die in der Tabelle angegebenen Gewichte können aus Produktionsgründen geringfügigen Abweichungen unterliegen.

Non si garantisce l'abbinabilità tra fondi di spessori diversi e tra fondo e pezzo speciale.
It is not guaranteed that background tiles with different thicknesses can be used together, nor is it guaranteed for background tiles and trims.
Nous ne garantissons pas la possibilité de combiner des carrelages de sol de différentes épaisseurs et un carrelage de sol avec une pièce spéciale.
Die Kombinierbarkeit von Fliesen unterschiedlicher Stärke sowie zwischen Fliese und Formteil kann nicht garantiert werden.

I mosaici "Blended" sono composti da un mix di tessere nelle 4 finiture disposte in modo casuale.
The Blended mosaics are composed of a mix of tiles in the 4 finishes arranged randomly.
Les mosaïques Blended sont composées d'un mélange de carreaux dans les 4 finitions disposées au hasard.
Die Blended-Mosaik bestehen aus einem Kachelmix in 4 Ausführungen, die auf zufällige Art und Weise angeordnet sind.

* A disposizione solo su richiesta. Tempi di consegna 30 gg.
Available upon request only. Delivery terms: 30 days.
Disponible seulement sur requête. Délais de livraison: 30 jours.
Verfügbar auf Anfrage. Lieferzeit: 30 Tage.

** Il peso è comprensivo dell'imballo.
The total weight includes the packaging.
Le poids comprend aussi l'emballage.
Das Gesamtgewicht enthält auch die Verpackung.

*** Vendita a scatola completa.
Full box sale.
Vente à la boîte complète.
Volle Kartons.

- Naturale e rettificato. Natural rectified. Naturel et rectifié. Natur Oberfläche und rektifiziert.
- Bocciardato rettificato. Bush-hammered rectified. Bouchardé rectifié. Gehämmert und rektifiziert.
- Lucidato e rettificato. Glossy rectified. Brillant et rectifié. Glossy/Shiny und rektifiziert.
- ◇ Velvet rettificato. Velvet rectified. Velvet rectifié. Velvet rektifiziert.

Spessore . Thickness . Epaisseur . Stärke - 9 mm R11 - 20 mm R11

Gres porcellanato colorato in massa. Full-body coloured porcelain stoneware. Grès cérame coloré dans la masse. In der Masse gefärbtes Feinsteinzeug.

OUTDOOR

TABELLA RIEPILOGATIVA
Summary table
Tableau récapitulatif
Zusammenfassende Tabelle

		120x120 48"x48"	60x120 24"x48"	120x120 48"x48"	80x80 31 1/2"x31 1/2"	60x120 24"x48"	*Elemento a L monolitico △ 15x30x4h 6"x12"x1 1/2"h
SPESSORE - THICKNESS - ÉPAISSEUR - STÄRKE		9 mm	9 mm	20 mm	20 mm	20 mm	9,5 mm
	□ Nat. Ret.	138125	138061	138115	138111	138065	
	■ Nat. Nat.						138501
	□ Nat. Ret.	138126	138062	138116	138112	138066	
	■ Nat. Nat.						138502
	□ Nat. Ret.	138127	138063	138117	138113	138067	
	■ Nat. Nat.						138503
	□ Nat. Ret.	138128	138064	138118	138114	138068	
	■ Nat. Nat.						138504
IMBALLI - PACKAGING EMBALLAGE - VERPACKUNG							
		Pallet speciale Special pallet 123x144	Pallet 80x120	Pallet speciale Special pallet 123x144	Pallet 80x120	Pallet 80x120	Pallet 80x120
N°							
m²							
** Kg							
		2	2	1	1	1	6
m² x		2,88	1,44	1,44	0,64	0,72	
Kg x		58	29	64	28,5	32	7,5
		18	30	18	45	30	
m² x		51,84	43,2	25,92	28,8	21,6	
** Kg x		1097	890	1205	1302,5	980	
h x		65	75	65	100	75	
Imballo (tara) - Packaging (tare)		(53)	(20)	(53)	(20)	(20)	(20)

I pesi riportati in tabella sono indicativi e potrebbero essere soggetti a leggere variazioni.
The weights stated in the chart may undergo slight changes for production reasons.
Les poids indiqués dans le tableau peuvent subir de légères variations pour des raisons de production.
Die in der Tabelle angegebenen Gewichte können aus Produktionsgründen geringfügigen Abweichungen unterliegen.

Non si garantisce l'abbinabilità tra fondi di spessori diversi e tra fondo e pezzo speciale.
It is not guaranteed that background tiles with different thicknesses can be used together, nor is it guaranteed for background tiles and trims.
Nous ne garantissons pas la possibilité de combiner des carrelages de sol de différentes épaisseurs et un carrelage de sol avec une pièce spéciale.
Die Kombinierbarkeit von Fliesen unterschiedlicher Stärke sowie zwischen Fliese und Formteil kann nicht garantiert werden.

** Il peso è comprensivo dell'imballo.
The total weight includes the packaging.
Le poids comprend aussi l'emballage.
Das Gesamtgewicht enthält auch die Verpackung.

□ Naturale e rettificato.
Natural rectified.
Naturel et rectifié.
Natur Oberfläche und rektifiziert.

■ Naturale e naturale.
Natural and natural.
Naturel et naturel.
Natur natur.

PEZZI SPECIALI PER ESTERNO 20 mm R11 - □ Nat. Ret.

Special pieces for outdoor - Pièces spéciales pour extérieur - Formteile für Aussenbereich

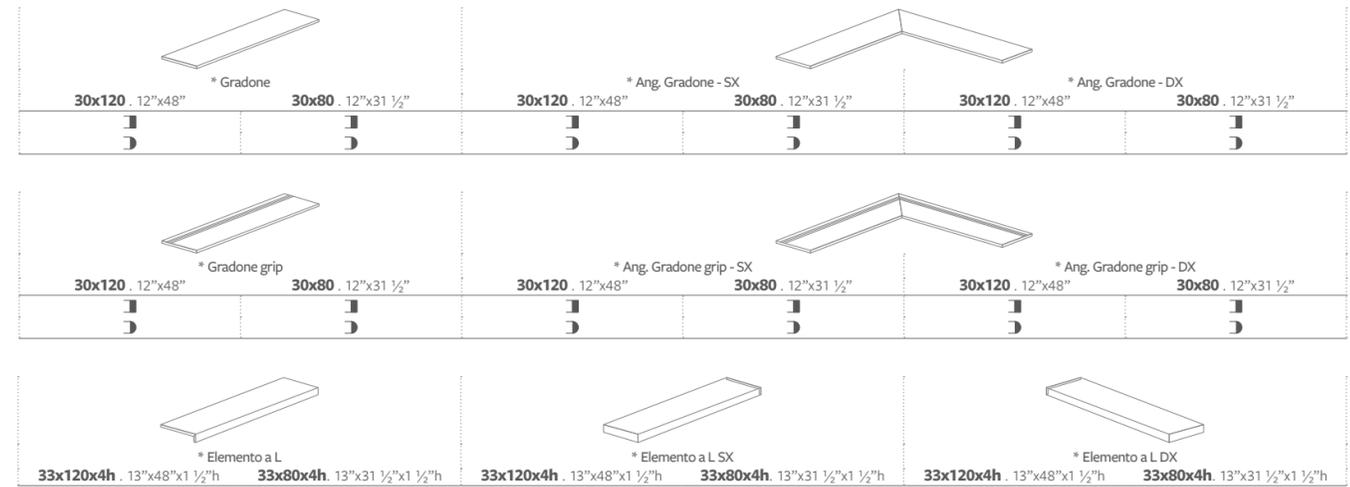

PEZZI SPECIALI PER PISCINA 20 mm R11 - □ Nat. Ret.

Special pieces for swimming pool - Pièces spéciales pour piscine - Formteile für Schwimmbad

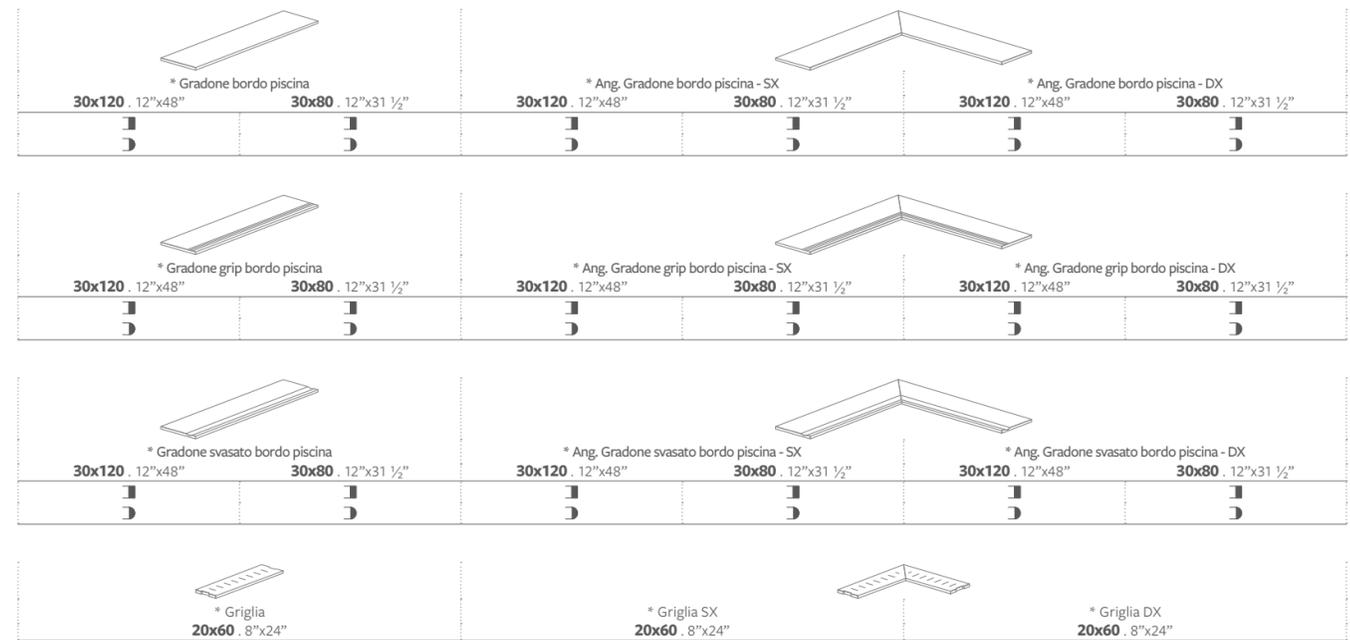

Per maggiori informazioni su imballi e codici articolo consultare la Sezione Tecnica: "Pezzi speciali per esterno" e "Pezzi speciali per piscina".
For more information on packaging and item codes, please refer to the Technical Section: "Special pieces for outdoor" and "Special pieces for swimming pools".
Pour plus d'informations sur les emballages et les codes articles, vous pouvez consulter la Section Technique: "Pièces spéciales pour extérieur" et "Pièces spéciales pour piscines".
Weitere Informationen für Verpackungen und Artikelcodes finden Sie im Technischen Abschnitt: "Formteile für Außenbereich" und "Formteile für Schwimmbad".

Supporti per pavimentazioni sopraelevate nella Sezione "Posa sopraelevata".
Supports for raised paving system, please refer to the Section: "Raised Laying".
Supports pour le système de carrelage surélevé dans la Section "Pose surélevée".
Stelzlagnern für Doppelboden Wire im Abschnitt "Verlegung auf Stelzlagnern".

* A disposizione solo su richiesta. Tempi di consegna 30 gg.
Available upon request only. Delivery terms: 30 days.
Disponibile seulement sur requête. Délais de livraison: 30 jours.
Verfügbar auf Anfrage. Lieferzeit: 30 Tage.

□ Costa retta.
Straight edge.
Bord droit.
Gerade Kante.

▤ Costa toro.
Bullnose edge.
Bord boudin.
Abgerundete Kante.

MEDITERRANEA

Ieri, oggi e domani: la storia, la contemporaneità e lo stile intramontabile dei panorami mediterranei sono le caratteristiche di **MEDITERRANEA**. Una collezione che si ispira alla pietra lì protagonista che, rimasta nuda allo sguardo, viene scaldata dal sole e levigata dalla natura. Una pietra dalle varie facce per le sue molte origini i cui bordi, lavorati dal tempo, le donano una profondità ed una personalità unica. Una pietra che sa essere classica e moderna allo stesso tempo, ricca di storia ma anche fonte di ispirazione per immaginare il futuro.

Yesterday, today, and tomorrow: the history, the modernity, and the timeless style of the Mediterranean landscapes are the traits of **MEDITERRANEA**. A collection inspired by the characteristic stone of that area, which, left naked to the eye, is warmed by the sun and smoothed by nature. A stone with many facets due to its many origins, whose edges, worn by time, give it a unique depth and personality. A stone that is classic and modern at the same time, rich in history but also a source of inspiration to imagine the future.

Hier, aujourd'hui et demain : l'histoire, la contemporanéité et le style intemporel des paysages méditerranéens sont les caractéristiques de **MEDITERRANEA**. Une collection inspirée par la pierre qui en est le protagoniste, laissée à nu, réchauffée par le soleil et polie par la nature. Une pierre aux multiples faces en raison de ses nombreuses origines, dont les arêtes, travaillées par le temps, lui donnent de la profondeur et une personnalité unique. Une pierre qui sait être à la fois classique et moderne, riche en histoire mais aussi source d'inspiration pour imaginer l'avenir.

Gestern, heute und morgen: Geschichte, Aktualität und der zeitlose Stil der mediterranen Landschaften sind die charakteristischen Merkmale von **MEDITERRANEA**. Eine Kollektion, die vom Stein inspiriert ist, dem Protagonisten, der sich in seiner Natürlichkeit präsentiert, von der Sonne erwärmt und von der Natur geglättet. Ein Stein mit vielen Gesichtern dank seiner vielfältigen Ursprünge, dessen von der Zeit geprägte Kanten ihm eine einzigartige Tiefe und Persönlichkeit verleihen. Ein Stein, der klassisch und modern zugleich ist, reich an Geschichte, aber auch eine Quelle der Inspiration für die Zukunft.

100% Made in Italy



MENFI 60x90 Nat. Ret.
 AMELIA "B" 20x20 Nat. Ret.
 AMELIA "B" 60x90 Nat. Ret.



SCALE . STAIRS
 DOR 90x90 Nat. Ret.
 Coprispigo triangolare DOR 1,4x90



7



MODULO C3
ERICA 60x90 Nat. Ret.
ERICA 60x60 Nat. Ret.
ERICA 30x60 Nat. Ret.



STONE & CLASSIC
COLLECTION

MEDITERRANEA



ERICE Nat. Ret.
Modulo D4
BANCONE . COUNTER Collection MARQUINA NERO 120x280 Lucidato Ret.





DOR Nat. Ret. R11

MODULO D2

40x60 Nat. Ret. R11 - 33,3%

40x40 Nat. Ret. R11 - 44,4%

20x40 Nat. Ret. R11 - 11,1%

20x20 Nat. Ret. R11 - 11,1%



D3

DOR

40x60 - 16"x24"
40x40 - 16"x16"
20x40 - 8"x16"
20x20 - 8"x8"



D4

ERICE

40x60 - 16"x24"
40x40 - 16"x16"
20x40 - 8"x16"
20x20 - 8"x8"

**PER MAGGIORI
INFORMAZIONI SUI MODULI
SCARICA IL MANUALE
"SCHEMI DI POSA"**

For further information about
laying patterns download our
"Laying pattern" catalogue.

Pour des informations
supplémentaires concernant
les plans de pose télécharger le
manuel "Plans de pose".

Laden Sie das Katalog
der Verlegemuster" für
weitere Informationen zum
Verlegungsschema.

Modularità / Modularity / Modularité / Modularität

MODULO

D3 40x60 - 46,1%
40x40 - 30,8%
20x40 - 15,4%
20x20 - 7,7%

MODULO

D4 40x60 - 40,0%
40x40 - 40,0%
20x40 - 13,3%
20x20 - 6,7%

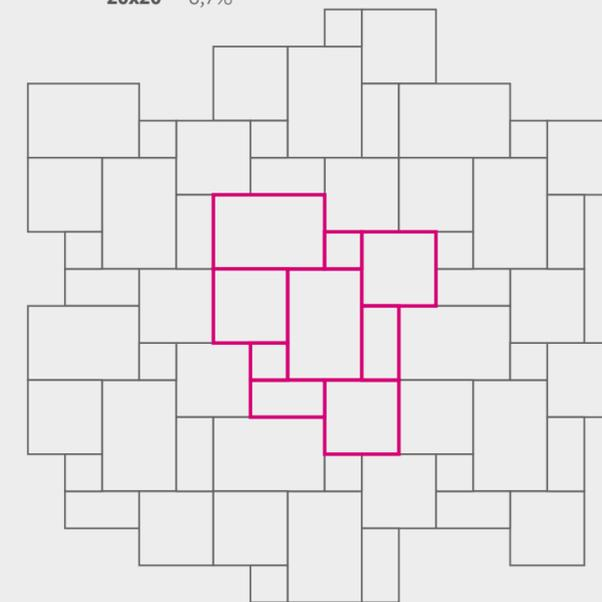
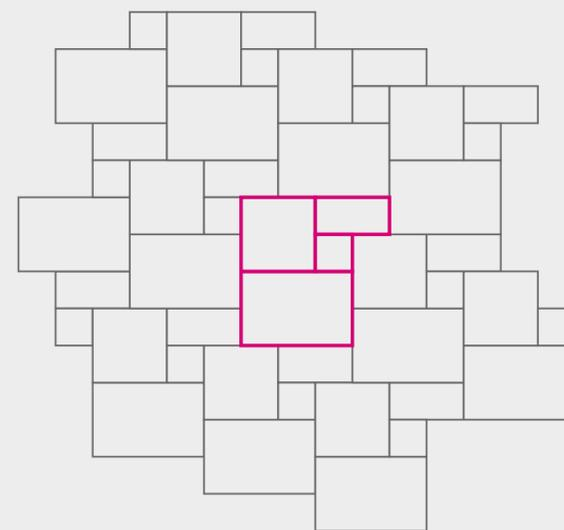

Per maggiori informazioni sui moduli consultare il manuale "Schemi di posa" sul sito www.tagina.it
For further information about laying patterns see our "Laying pattern" manual which is available to download from our website: www.tagina.it.
Pour des informations supplémentaires concernant les plans de pose veuillez consulter le manuel "Plans de pose" téléchargées sur le site Internet www.tagina.it.
Auf der Seite www.tagina.it unter dem Katalog der "Verlegemuster" können Sie weitere Informationen zum Verlegungsschema finden.



C3

BYBLOS

60x90 - 24"x35 1/2"
60x60 - 24"x24"
30x60 - 12"x24"



C4

MENFI

60x90 - 24"x35 1/2"
60x60 - 24"x24"
30x60 - 12"x24"

**PER MAGGIORI
INFORMAZIONI SUI MODULI
SCARICA IL MANUALE
"SCHEMI DI POSA"**

For further information about
laying patterns download our
"Laying pattern" catalogue.

Pour des informations
supplémentaires concernant
les plans de pose télécharger le
manuel "Plans de pose".

Laden Sie das Katalog
der Verlegemuster" für
weitere Informationen zum
Verlegungsschema.

Modularità / Modularity / Modularité / Modularität

MODULO

C3 **60x90** - 50,0%
60x60 - 33,3%
30x60 - 16,7%

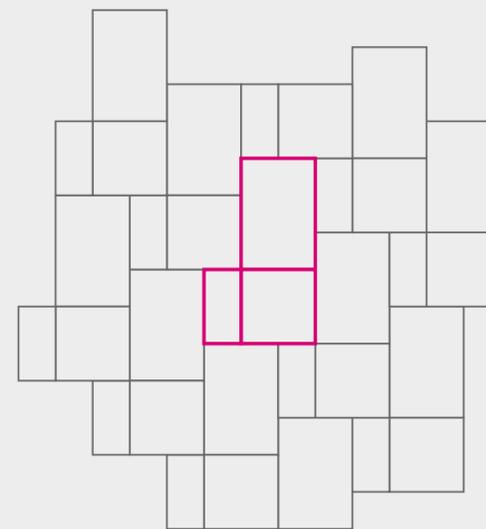

MODULO

C4 **60x90** - 50,0%
60x60 - 33,3%
30x60 - 16,7%

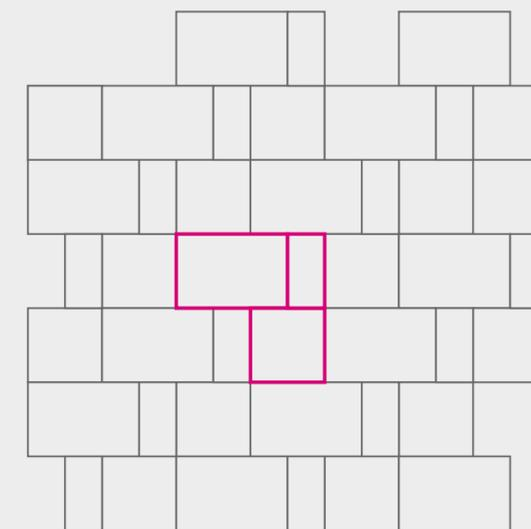

Per maggiori informazioni sui moduli consultare il manuale "Schemi di posa" sul sito www.tagina.it
For further information about laying patterns see our "Laying pattern" manual which is available to download from our website: www.tagina.it.
Pour des informations supplémentaires concernant les plans de pose veuillez consulter le manuel "Plans de pose" téléchargées sur le site Internet www.tagina.it.
Auf der Seite www.tagina.it unter dem Katalog der "Verlegemuster" können Sie weitere Informationen zum Verlegungsschema finden.

FORMATI

Sizes / Formats / Formate

10 mm . 90x90 - 35 1/2"x35 1/2" / 60x90 - 24"x35 1/2" / 60x60 - 24"x24" / 30x60 - 12"x24"

40x60 - 16"x24" / 40x40 - 16"x16" / 20x40 - 8"x16" / 20x20 - 8"x8"

10 mm R11 . 60x90 - 24"x35 1/2" / 40x60 - 16"x24" / 40x40 - 16"x16" / 20x40 - 8"x16" / 20x20 - 8"x8"

20 mm R11 . 90x90 - 35 1/2"x35 1/2" / 60x90 - 24"x35 1/2"

COLORI

Colours / Couleurs / Farben



BYBLOS

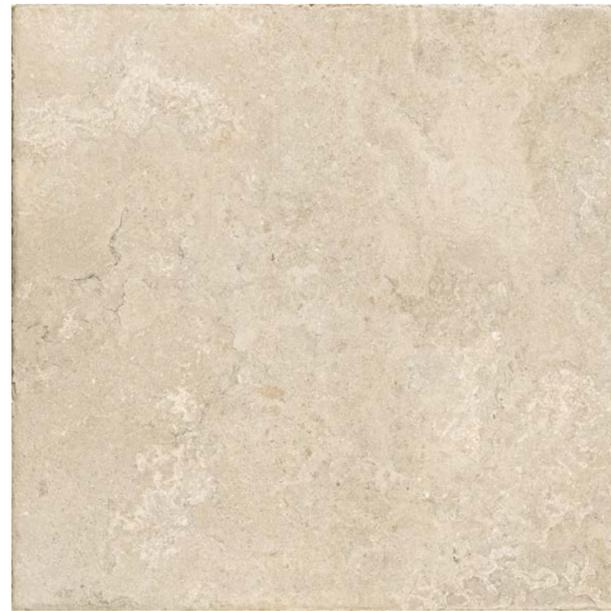

DOR



ERICE



MENFI

CONTINUITÀ PROGETTUALE INDOOR-OUTDOOR

Design continuity indoors and out / Continuité conceptuelle à l'intérieur et à l'extérieur / Entwurfskontinuität im innen-und Aussenbereich



INDOOR

Soluzioni contemporanee per l'interior design.
Contemporary solutions for interior design.
Solutions contemporaines pour le design intérieur.
Zeitgemäße Lösungen für das Interior Design.

SPESORE
THICKNESS
10mm



OUTDOOR

Versatilità e prestazioni per la progettazione in esterna.
Versatility and performance for outdoor design.
Polyvalence et performance pour l'aménagement extérieur.
Vielseitigkeit und Leistungen für Outdoor-Design.

SPESORE
THICKNESS
10mm

SPESORE
THICKNESS
20mm

R11
A+B+C

SISTEMI DI POSA

Laying systems / Systemes de pose / Verlegearten

Posa su erba
Laying on grass
Pose sur l'herbe
Verlegung auf Wiese

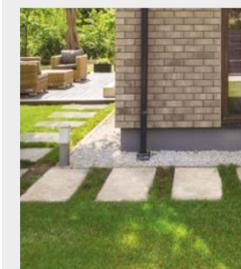

Posa su sabbia
Laying on sand
Pose sur sable
Verlegung auf Sand



Posa sopraelevata
Raised laying
Pose surélevée
Verlegung auf Stelzlagern



Posa su ghiaia
Laying on gravel
Pose sur gravier
Verlegung auf Kies



Posa tradizionale
Standard laying
Pose traditionnelle
Herkömmliche Verlegung

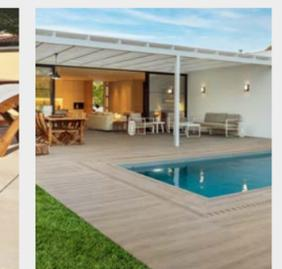

Spessore . Thickness . Epaisseur . Stärke - **10 mm - 20 mm R11**

Gres porcellanato colorato in massa. Full-body coloured porcelain stoneware. Grès cérame coloré dans la masse. In der Masse gefärbtes Feinsteinzeug.

DECORI

Decors / Décors / Dekore

INDOOR

10 mm . 20x20 - 8"x8"

AMELIA "A"

Fino a 16 grafiche . Up to 16 graphics. Jusqu'à 16 graphismes. Bis zum 16 Grafiken



10 mm . 20x20 - 8"x8"

AMELIA "B"

Fino a 16 grafiche . Up to 16 graphics. Jusqu'à 16 graphismes. Bis 16 Grafiken



10 mm . 60x90 - 24"x35 1/2"

AMELIA "A"

Fino a 3 grafiche . Up to 3 graphics. Jusqu'à 3 graphismes. Bis zum 3 Grafiken



AMELIA "B"



OUTDOOR

20 mm R11 . 60x90 - 24"x35 1/2"

ERACLEA

Fino a 60 grafiche . Up to 60 graphics. Jusqu'à 60 graphismes. Bis zum 60 Grafiken



ERACLEA DOR



ERACLEA BYBLOS



ERACLEA ERICE



ERACLEA MENFI



All'interno delle scatole il mix dei soggetti del decoro è del tutto casuale. In alcune scatole qualche soggetto potrebbe ripetersi.
The mix of decor patterns within each box is entirely random. Some of the decor patterns within each box may be the same.
A l'intérieur des boîtes le mélange des sujets de décoration est complètement aléatoire. Dans certaines boîtes parfois les sujets peuvent se répéter.
Im Inneren der Kartons kommt die Mischung der Motive einzelner Dekore völlig zufällig vor. In einigen Kartons können sich einige Motive wiederholen.

I Decori Amelia si abbinano al fondo ma possono essere di tonalità diversa.
Amelia Decors match the base but may be of a different tone.
Les décors Amelia sont assortis au fond, mais les tonalités peuvent être différentes.
Die Dekore Amelia passen zum Unifliese, können jedoch unterschiedliche Farbtöne aufweisen.

Spessore . Thickness . Epaisseur . Stärke - 10 mm

Gres porcellanato colorato in massa. Full-body coloured porcelain stoneware. Grès cérame coloré dans la masse. In der Masse gefärbtes Feinsteinzeug.

INDOOR

TABELLA RIEPILOGATIVA
Summary table
Tableau récapitulatif
Zusammenfassende Tabelle

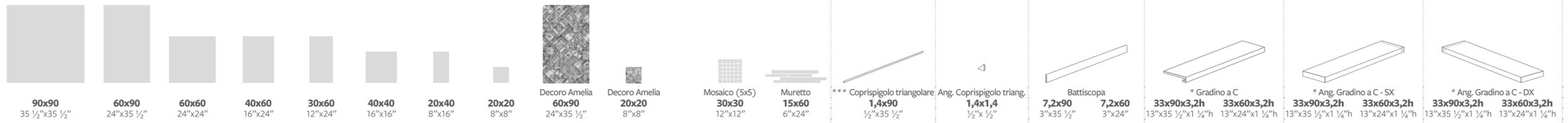

SPESSORE - THICKNESS - EPAISSEUR - STÄRKE		10 mm	10 mm	10 mm	10 mm	10 mm	10 mm	10 mm	10 mm	10 mm	10 mm	10 mm	10 mm	10 mm	10 mm	10 mm	10 mm	10 mm	10 mm	10 mm	10 mm	10 mm	
	DOR <input type="checkbox"/> Nat. Ret.	128015	128025	128035	128045	128055	128065	128075	128085	(A) 128090	(A) 128092	128301	128311	128401	128411	128101	128111	128201	128211	128231	128251	128221	128241
	BYBLOS <input type="checkbox"/> Nat. Ret.	128016	128026	128036	128046	128056	128066	128076	128086			128302	128312	128402	128412	128102	128112	128202	128212	128232	128252	128222	128242
	ERICE <input type="checkbox"/> Nat. Ret.	128017	128027	128037	128047	128057	128067	128077	128087	(B) 128091	(B) 128093	128303	128313	128403	128413	128103	128113	128203	128213	128233	128253	128223	128243
	MENFI <input type="checkbox"/> Nat. Ret.	128018	128028	128038	128048	128058	128068	128078	128088			128304	128314	128404	128414	128104	128114	128204	128214	128234	128254	128224	128244
IMBALLI - PACKAGING EMBALLAGE - VERPACKUNG																							
		Pallet	Pallet	Pallet	Pallet	Pallet	Pallet	Pallet	Pallet	Pallet	Pallet	Pallet	Pallet			Pallet	Pallet	Pallet	Pallet	Pallet	Pallet	Pallet	Pallet
		94x120	94x120	80x120	80x120	80x120	80x120	80x120	80x120	94x120	80x120	80x120	80x120			80x120	80x120	80x120	80x120	80x120	80x120	80x120	80x120
N°																							
m²																							
** Kg																							
		2	2	3	4	6	6	8	16	2	16	11	3	6		8	14	2	4	1	2	1	2
m² x		1,62	1,08	1,08	0,96	1,08	0,96	0,64	0,64	1,08	0,64	0,99	0,27										
Kg x		37	24	24	21,5	24	21,5	14	14	24	14	20,5	6	2		11	11,7	16,5	22	8,5	11	8,5	11
		20	48	40	48	40	60	72	72	48	72												
m² x		32,4	51,84	43,2	46,08	43,2	57,6	46,08	46,08	51,84	46,08												
** Kg x		760	1172	980	1052	980	1310	1028	1028	1172	1028												
h x		64	75	75	73	75	94	73	73	75	73												
Imballo (tara) - Packaging (tare)		(20)	(20)	(20)	(20)	(20)	(20)	(20)	(20)	(20)	(20)	(20)	(20)			(20)	(20)	(20)	(20)	(20)	(20)	(20)	(20)

	MODULO C3 60x90 - 60x60- 30x60	MODULO C4 60x90 - 60x60- 30x60	MODULO D3 40x60 - 40x40- 20x40 - 20x20	MODULO D4 40x60 - 40x40- 20x40 - 20x20
SPESSORE - THICKNESS - EPAISSEUR - STÄRKE	10 mm	10 mm	10 mm	10 mm

I pesi riportati in tabella sono indicativi e potrebbero essere soggetti a leggere variazioni.
The weights stated in the chart may undergo slight changes for production reasons.
Les poids indiqués dans le tableau peuvent subir de légères variations pour des raisons de production.
Die in der Tabelle angegebenen Gewichte können aus Produktionsgründen geringfügigen Abweichungen unterliegen.

Non si garantisce l'abbinabilità tra fondi di spessori diversi e tra fondo e pezzo speciale.
It is not guaranteed that background tiles with different thicknesses can be used together, nor is it guaranteed for background tiles and trims.
Nous ne garantissons pas la possibilité de combiner des carrelages de sol de différentes épaisseurs et un carrelage de sol avec une pièce spéciale.
Die Kombinierbarkeit von Fliesen unterschiedlicher Stärke sowie zwischen Fliese und Formteil kann nicht garantiert werden.

* A disposizione solo su richiesta. Tempi di consegna 30 gg.
Available upon request only. Delivery terms: 30 days.
Disponible seulement sur requête. Délais de livraison: 30 jours.
Verfügbar auf Anfrage. Lieferzeit: 30 Tage.

** Il peso è comprensivo dell'imballo.
The total weight includes the packaging.
Le poids comprend aussi l'emballage.
Das Gesamtgewicht enthält auch die Verpackung.

*** Vendita a scatola completa.
Full box sale.
Vente à la boîte complète.
Volle Kartons.

Naturale e rettificato.
Natural rectified.
Naturel et rectifié.
Natur Oberfläche und rektifiziert.

Spessore . Thickness . Epaisseur . Stärke - 10 mm R11 - 20 mm R11

Gres porcellanato colorato in massa. Full-body coloured porcelain stoneware. Grès cérame coloré dans la masse. In der Masse gefärbtes Feinsteinzeug.

OUTDOOR

TABELLA RIEPILOGATIVA
Summary table
Tableau récapitulatif
Zusammenfassende Tabelle

		60x90 24"x35 1/2"	40x60 16"x24"	40x40 16"x16"	20x40 8"x16"	20x20 8"x8"	90x90 35 1/2"x35 1/2"	60x90 24"x35 1/2"	Dec. Eraclea 60x90 24"x35 1/2"	Elemento a L monolitico △ 15x30x4h 6"x12"x1 1/2"h
SPESSORE - THICKNESS - EPAISSEUR - STÄRKE		10 mm	10 mm	10 mm	10 mm	10 mm	20 mm	20 mm	20 mm	9,5 mm
DOR R11	□ Nat. Ret.	128021	128041	128061	128071	128081	128001	128005	128096	
	■ Nat. Nat.									128261
BYBLOS R11	□ Nat. Ret.	128022	128042	128062	128072	128082	128002	128006	128097	
	■ Nat. Nat.									128262
ERICE R11	□ Nat. Ret.	128023	128043	128063	128073	128083	128003	128007	128098	
	■ Nat. Nat.									128263
MENFI R11	□ Nat. Ret.	128024	128044	128064	128074	128084	128004	128008	128099	
	■ Nat. Nat.									128264
IMBALLI - PACKAGING EMBALLAGE - VERPACKUNG										
		Pallet	Pallet	Pallet	Pallet	Pallet	Pallet	Pallet	Pallet	Pallet
		94x120	80x120	80x120	80x120	80x120	94x94	96x126	96x126	80x120
N°										
m²										
** Kg										
		2	4	6	8	16	1	1	1	6
m² x		1,08	0,96	0,96	0,64	0,64	0,81	0,54	0,54	
Kg x		24	21,5	21,5	14	14	37	24	24	7,5
		48	48	60	72	72	30	48	48	
m² x		51,84	46,08	57,6	46,08	46,08	24,3	25,92	25,92	
** Kg x		1172	1052	1310	1028	1028	1130	1172	1172	
h x		75	73	94	73	73	80	70	70	
Imballo (tara) - Packaging (tare)		(20)	(20)	(20)	(20)	(20)	(20)	(20)	(20)	(20)

I pesi riportati in tabella sono indicativi e potrebbero essere soggetti a leggere variazioni.
The weights stated in the chart may undergo slight changes for production reasons.
Les poids indiqués dans le tableau peuvent subir de légères variations pour des raisons de production.
Die in der Tabelle angegebenen Gewichte können aus Produktionsgründen geringfügigen Abweichungen unterliegen.

Non si garantisce l'abbinabilità tra fondi di spessori diversi e tra fondo e pezzo speciale.
It is not guaranteed that background tiles with different thicknesses can be used together, nor is it guaranteed for background tiles and trims.
Nous ne garantissons pas la possibilité de combiner des carrelages de sol de différentes épaisseurs et un carrelage de sol avec une pièce spéciale.
Die Kombinierbarkeit von Fliesen unterschiedlicher Stärke sowie zwischen Fliese und Formteil kann nicht garantiert werden.

** Il peso è comprensivo dell'imballo.
The total weight includes the packaging.
Le poids comprend aussi l'emballage.
Das Gesamtgewicht enthält auch die Verpackung.

□ Naturale e rettificato. Natural rectified. Naturel et rectifié. Natur Oberfläche und rektifiziert.

■ Naturale e naturale. Natural and natural. Naturel et naturel. Natur natur.

△ Monolitico. Monolithic step. Monolitico. Monolithische Stufenplatte.

PEZZI SPECIALI PER ESTERNO 20 mm R11 - □ Nat. Ret.

Special pieces for outdoor - Pièces spéciales pour extérieur - Formteile für Aussenbereich

	* Gradone 30x90 . 12"x35 1/2"		* Ang. Gradone - SX 30x90 . 12"x35 1/2"		* Ang. Gradone - DX 30x90 . 12"x35 1/2"
	* Gradone grip 30x90 . 12"x35 1/2"		* Ang. Gradone grip - SX 30x90 . 12"x35 1/2"		* Ang. Gradone grip - DX 30x90 . 12"x35 1/2"
	* Elemento a L 33x90x4h . 13"x35 1/2"x1 1/2"h		* Elemento a L SX 33x90x4h . 13"x35 1/2"x1 1/2"h		* Elemento a L DX 33x90x4h . 13"x35 1/2"x1 1/2"h

PEZZI SPECIALI PER PISCINA 20 mm R11 - □ Nat. Ret.

Special pieces for swimming pool - Pièces spéciales pour piscine - Formteile für Schwimmbad

	* Gradone bordo piscina 30x90 . 12"x35 1/2"		* Ang. Gradone bordo piscina - SX 30x90 . 12"x35 1/2"		* Ang. Gradone bordo piscina - DX 30x90 . 12"x35 1/2"
	* Gradone grip bordo piscina 30x90 . 12"x35 1/2"		* Ang. Gradone grip bordo piscina - SX 30x90 . 12"x35 1/2"		* Ang. Gradone grip bordo piscina - DX 30x90 . 12"x35 1/2"
	* Gradone svasato bordo piscina 30x90 . 12"x35 1/2"		* Ang. Gradone svasato bordo piscina - SX 30x90 . 12"x35 1/2"		* Ang. Gradone svasato bordo piscina - DX 30x90 . 12"x35 1/2"
	* Griglia 20x60 . 8"x24"		* Griglia SX 20x60 . 8"x24"		* Griglia DX 20x60 . 8"x24"

Per maggiori informazioni su imballi e codici articolo consultare la Sezione Tecnica: "Pezzi speciali per esterno" e "Pezzi speciali per piscina".
For more information on packaging and item codes, please refer to the Technical Section: "Special pieces for outdoor" and "Special pieces for swimming pools".
Pour plus d'informations sur les emballages et les codes articles, vous pouvez consulter la Section Technique: "Pièces spéciales pour extérieur" et "Pièces spéciales pour piscines".
Weitere Informationen für Verpackungen und Artikelcodes finden Sie im Technischen Abschnitt: "Formteile für Außenbereich" und "Formteile für Schwimmbad".

Supporti per pavimentazioni sopraelevate nella Sezione "Posa sopraelevata".
Sopports for raised paving system, please refer to the Section: "Raised Laying".
Supports pour le système de carrelage surélevé dans la Section "Pose surélevée".
Stelzlagern für Doppelboden Wire im Abschnitt "Verlegung auf Stelzlagern".

* A disposizione solo su richiesta. Tempi di consegna 30 gg.
Available upon request only. Delivery terms: 30 days.
Disponible seulement sur requête. Délais de livraison: 30 jours.
Verfügbar auf Anfrage. Lieferzeit: 30 Tage.

Costa retta. Straight edge. Bord droit. Gerade Kante.

Costa toro. Bullnose edge. Bord boudin. Abgerundete Kante.

NAMUR

NAMUR si ispira alla Pierre Bleu o Pietra Blu, la tipica roccia sedimentaria belga dalle caratteristiche sfumature grigio-blu. Nell'interpretazione di **Tagina**, la pietra assume molteplici tonalità di colore che spaziano dal nero al beige, fino al grigio, per un uso concepito in piena continuità cromatica e di formato tra ambienti interni ed esterni grazie alle eccezionali caratteristiche di ingelività e durezza tipiche del gres porcellanato.

NAMUR is inspired by Pierre Bleue or Blue Stone, the Belgian sedimentary rock with characteristic grey-blue hues. In **Tagina's** interpretation, the stone takes on multiple shades of colour ranging from black to beige, up to grey, in full chromatic and size continuity with both internal and external environments thanks to the exceptional characteristics of frost resistance and durability typical of porcelain stoneware.

NAMUR s'inspire de la Pierre Bleue ou Pietra Blu, la roche sédimentaire caractéristique de couleur bleu gris provenant de Belgique. Dans l'interprétation de **Tagina**, la pierre prend de multiples nuances de couleur allant du noir au beige, jusqu'au gris, pour un usage conçu en pleine continuité chromatique et dimensionnelle entre l'intérieur et l'extérieur grâce aux caractéristiques exceptionnelles de résistance au gel et de durabilité typique du grès cérame.

NAMUR ist inspiriert vom Pierre Bleue oder Blaustein, dem typischen belgischen Sedimentgestein mit seinen charakteristischen graublauen Farbtönen. In der Interpretation von **Tagina** nimmt der Stein mehrere Farbtöne an, die von Schwarz über Beige bis hin zu Grau reichen, für eine Verwendung, die dank der außergewöhnlichen Frostbeständigkeit und der für Feinsteinzeug typischen Dauerhaftigkeit in voller Farb- und Formatkontinuität zwischen Innen- und Außenbereichen konzipiert ist.

100% Made in Italy





FONCÉ 90x90 Nat. Ret.



FONCÉ 90x90 20 mm Nat. Ref. R11



RIVESTIMENTO . WALL
FONCE Mosaico 30x30 Nat. Ret.

LAVABO - WASHBASIN
Collection CALACATTA GOLD 6 mm Nat.

PAVIMENTO . FLOOR
FONCE Esagono 25x22 Nat. Nat.



TAVOLO . TABLE:
STATUARIO 6 mm Nat.

PAVIMENTO . FLOOR:
CENDRE Esagono 25x22 Nat. Nat.
CENDRE Esagono Astrid 25x22 Nat. Nat.



NAMUR

FORMATI

Sizes / Formats / Formate

10 mm . 90x90 - 35 1/2"x35 1/2" / 60x90 - 24"x35 1/2" / 60x60 - 24"x24" / Esagono 25x22 - 10"x8 1/2"
20 mm R11 . 90x90 - 35 1/2"x35 1/2" / 60x90 - 24"x35 1/2" / 60x60 - 24"x24"

COLORI

Colours / Couleurs / Farben



BLANCHE

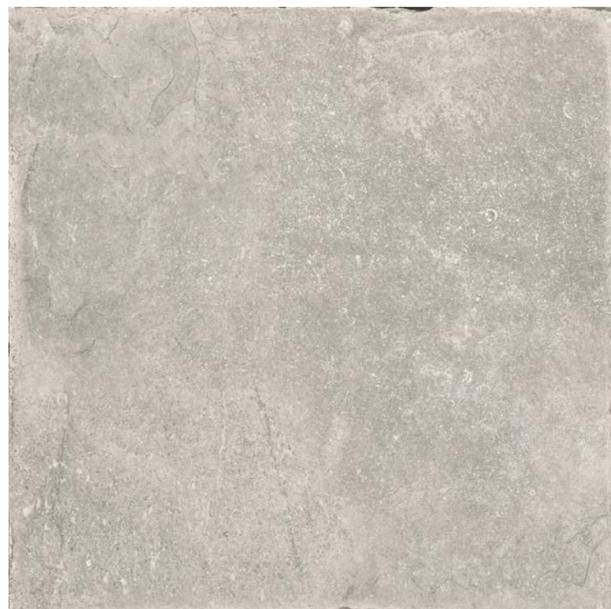

CENDRE



FONCÉ

CONTINUITÀ PROGETTUALE INDOOR-OUTDOOR

Design continuity indoors and out / Continuité conceptuelle à l'intérieur et à l'extérieur / Entwurfskontinuität im innen-und Aussenbereich



INDOOR

Soluzioni contemporanee per l'interior design
Contemporary solutions for interior design.
Solutions contemporaines pour le design intérieur.
Zeitgemäße Lösungen für das Interior Design.



OUTDOOR

Versatilità e prestazioni per la progettazione in esterna
Versatility and performance for outdoor design.
Polyvalence et performance pour l'aménagement extérieur.
Vielseitigkeit und Leistungen für Outdoor-Design.

SISTEMI DI POSA

Laying systems / Systemes de pose / Verlegearten

Posa su erba
Laying on grass
Pose sur l'herbe
Verlegung auf Wiese



Posa su sabbia
Laying on sand
Pose sur sable
Verlegung auf Sand



Posa sopraelevata
Raised laying
Pose surélevée
Verlegung auf Stelzlagern

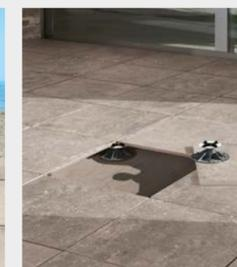

Posa su ghiaia
Laying on gravel
Pose sur gravier
Verlegung auf Kies



Posa tradizionale
Standard laying
Pose traditionnelle
Herkömmliche Verlegung



Spessore . Thickness . Epaisseur . Stärke - **10 mm****Gres porcellanato colorato in massa** . Full-body coloured porcelain stoneware . Grès cérame coloré dans la masse . In der Masse gefärbtes Feinsteinzeug.**DECORI**

Decors / Décors / Dekore

ESAGONO ASTRID**25x22** - 10"x8 1/2"**Fino a 45 grafiche per colore** . Up to 45 graphics per colours . Jusqu'à 45 graphismes par couleur . Bis zum 45 Grafiken pro Farbe

BLANCHE



CENDRE

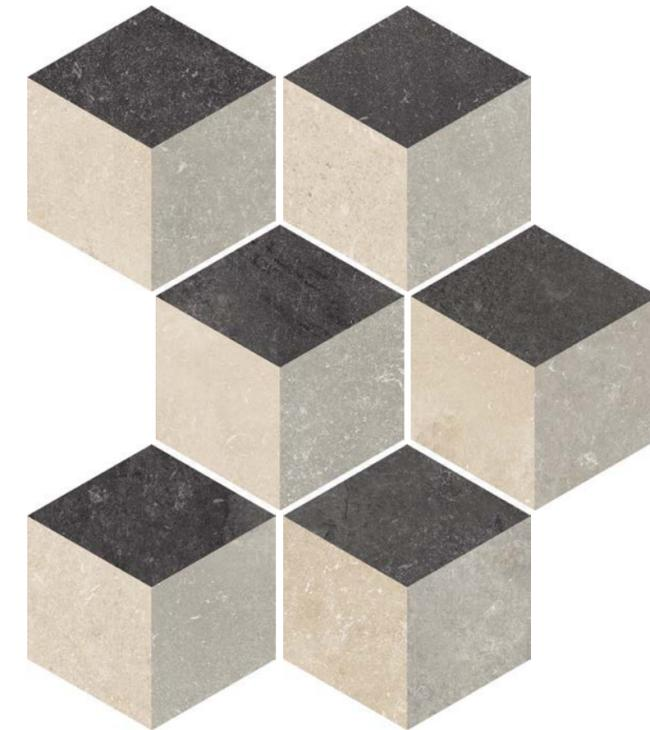

FONCÉ

**ESAGONO CUBE****25x22** - 10"x8 1/2"**Fino a 42 grafiche** . Up to 42 graphics . Jusqu'à 42 graphismes . Bis zum 42 Grafiken**MOSAICO (5x5)****30x30** - 12"x12"

BLANCHE



CENDRE

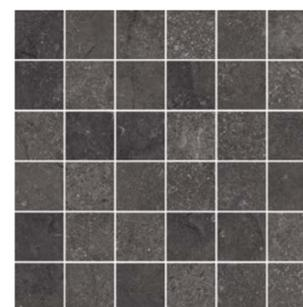

FONCÉ

**COPRISPIGOLO TRIANGOLARE****1,4x90** - 1/2"x35 1/2"

BLANCHE



CENDRE



FONCÉ



All'interno delle scatole il mix dei soggetti del decoro è del tutto casuale. In alcune scatole qualche soggetto potrebbe ripetersi.
The mix of decor patterns within each box is entirely random. Some of the decor patterns within each box may be the same.
A l'intérieur des boîtes le mélange des sujets de décoration est complètement aléatoire. Dans certaines boîtes parfois les sujets peuvent se répéter.
Im Inneren der Kartons kommt die Mischung der Motive einzelner Dekore völlig zufällig vor. In einigen Kartons können sich einige Motive wiederholen.

I decori si abbinano al fondo ma possono essere di tonalità diversa.
Decors match the base but may be of a different tone.
Les décors sont assortis au fond, mais les tonalités peuvent être différentes.
Die Dekore passen zum Unifliese, können jedoch unterschiedliche Farbtöne aufweisen.

Spessore . Thickness . Epaisseur . Stärke - 10 mm

Gres porcellanato colorato in massa. Full-body coloured porcelain stoneware. Grès cérame coloré dans la masse. In der Masse gefärbtes Feinsteinzeug.

INDOOR

TABELLA RIEPILOGATIVA
Summary table
Tableau récapitulatif
Zusammenfassende Tabelle

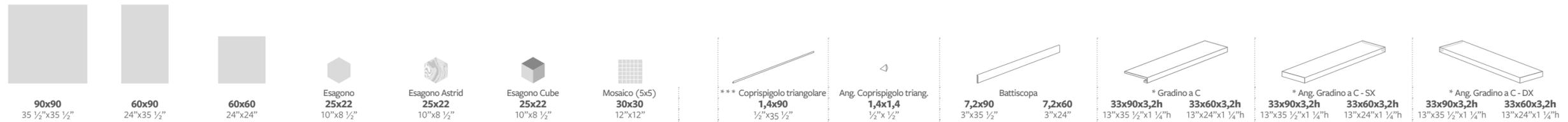

SPESSORE - THICKNESS - EPAISSEUR - STÄRKE		10 mm	10 mm	10 mm	10 mm	10 mm	10 mm	10 mm	10 mm	10 mm	10 mm	10 mm	10 mm	10 mm	10 mm	10 mm	10 mm			
	□ Nat. Ret.	136001	136007	136011				136301		136401	136411	136101	136111	136201	136211	136231	136251	136221	136241	
	■ Nat. Nat.				136021	136027	136030													
	□ Nat. Ret.	136003	136008	136013				136303		136403	136413	136103	136113	136203	136213	136233	136253	136223	136243	
	■ Nat. Nat.				136023	136028	136030													
	□ Nat. Ret.	136005	136009	136015				136305		136405	136415	136105	136115	136205	136215	136235	136255	136225	136245	
	■ Nat. Nat.				136025	136029	136030													
IMBALLI - PACKAGING EMBALLAGE - VERPACKUNG																				
	Pallet	Pallet	Pallet	Pallet	Pallet	Pallet	Pallet	Pallet				Pallet	Pallet	Pallet	Pallet	Pallet	Pallet	Pallet	Pallet	Pallet
		94x120	94x120	80x120	80x120	80x120	80x120	80x120				80x120	80x120	80x120	80x120	80x120	80x120	80x120	80x120	80x120
N°																				
m²																				
Kg																				
x		2	2	3	9	9	9	11		6		8	14	2	4	1	2	1	2	
m² x		1,62	1,08	1,08	0,37	0,37	0,37	0,99												
Kg x		37	24	24	8,2	8,2	8,2	20,5		2		11	11,7	16,5	22	8,5	11	8,5	11	
x		20	48	40	72	72	72													
m² x		32,4	51,84	43,2	26,64	26,64	26,64													
** Kg x		760	1172	980	611	611	611													
h x		64	75	75																
Imballo (tara) - Packaging (tare)		(20)	(20)	(20)	(20)	(20)	(20)	(20)				(20)	(20)	(20)	(20)	(20)	(20)	(20)	(20)	(20)

I pesi riportati in tabella sono indicativi e potrebbero essere soggetti a leggere variazioni.
The weights stated in the chart may undergo slight changes for production reasons.
Les poids indiqués dans le tableau peuvent subir de légères variations pour des raisons de production.
Die in der Tabelle angegebenen Gewichte können aus Produktionsgründen geringfügigen Abweichungen unterliegen.

Non si garantisce l'abbinabilità tra fondi di spessori diversi e tra fondo e pezzo speciale.
It is not guaranteed that background tiles with different thicknesses can be used together, nor is it guaranteed for background tiles and trims.
Nous ne garantissons pas la possibilité de combiner des carrelages de sol de différentes épaisseurs et un carrelage de sol avec une pièce spéciale.
Die Kombinierbarkeit von Fliesen unterschiedlicher Stärke sowie zwischen Fliese und Formteil kann nicht garantiert werden.

* A disposizione solo su richiesta. Tempi di consegna 30 gg.
Available upon request only. Delivery terms: 30 days.
Disponibile seulement sur requête. Délais de livraison: 30 jours.
Verfügbar auf Anfrage. Lieferzeit: 30 Tage.

** Il peso è comprensivo dell'imballo.
The total weight includes the packaging.
Le poids comprend aussi l'emballage.
Das Gesamtgewicht enthält auch die Verpackung.

*** Vendita a scatola completa.
Full box sale.
Vente à la boîte complète.
Volle Kartons.

□ Naturale e rettificato.
Natural rectified.
Naturel et rectifié.
Natur Oberfläche und rektifiziert.

■ Naturale e naturale.
Natural and natural.
Naturel et naturel.
Natur natur.

Spessore . Thickness . Epaisseur . Stärke - 20 mm R11

Gres porcellanato colorato in massa. Full-body coloured porcelain stoneware. Grès cérame coloré dans la masse. In der Masse gefärbtes Feinsteinzeug.

OUTDOOR

TABELLA RIEPILOGATIVA
Summary table
Tableau récapitulatif
Zusammenfassenden Tabelle

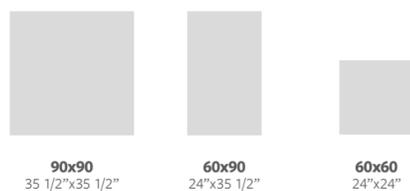

SPESSORE - THICKNESS - EPAISSEUR - STÄRKE	20 mm	20 mm	20 mm
BLANCHE R11 □ Nat. Ret.	136041	136045	136051
CENDRE R11 □ Nat. Ret.	136042	136046	136052
FONCÉ R11 □ Nat. Ret.	136043	136047	136053
IMBALLI - PACKAGING EMBALLAGE - VERPACKUNG			
	Pallet	Pallet	Pallet
	94x94	94x120	80x120
N° □			
m²			
Kg			
x	1	1	2
m² x	0,81	0,54	0,72
Kg x	37	24	32
x	30	45	32
m² x	24,3	24,3	23,04
** Kg x	1130	1100	1044
h x	80	75	75
Imballo (tara) - Packaging (tare)	(20)	(20)	(20)

PEZZI SPECIALI PER ESTERNO 20 mm R11 - □ Nat. Ret.

Special pieces for outdoor - Pièces spéciales pour extérieur - Formteile für Aussenbereich

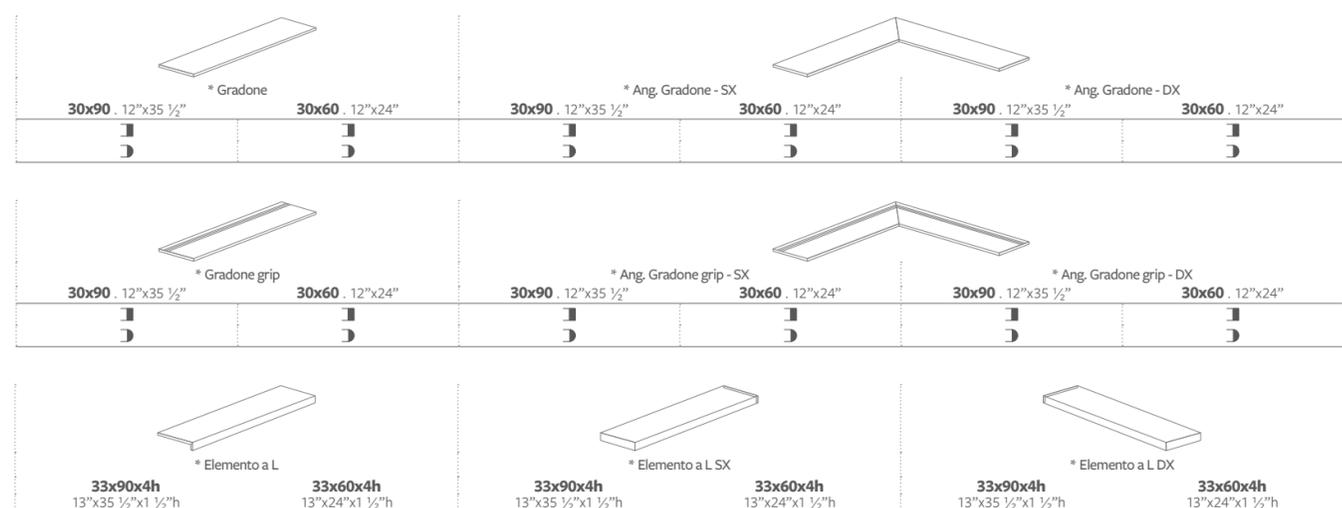

PEZZI SPECIALI PER PISCINA 20 mm R11 - □ Nat. Ret.

Special pieces for swimming pool - Pièces spéciales pour piscine - Formteile für Schwimmbad

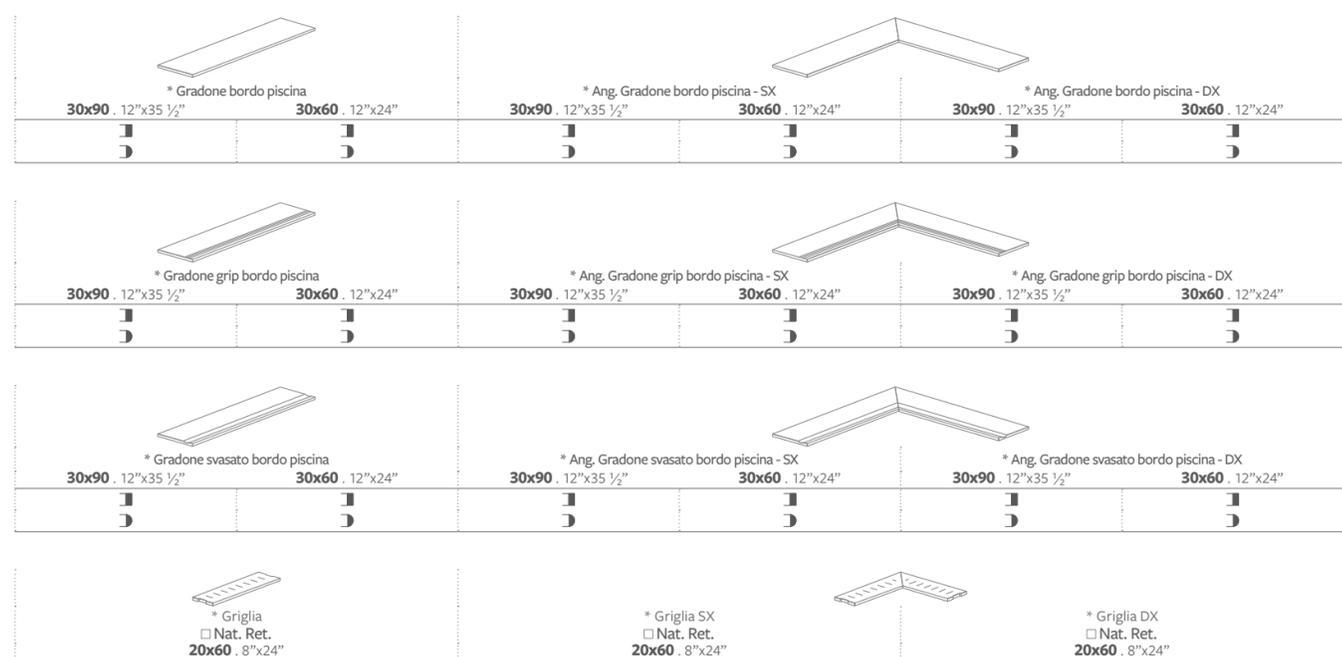

I pesi riportati in tabella sono indicativi e potrebbero essere soggetti a leggere variazioni.
The weights stated in the chart may undergo slight changes for production reasons.
Nous ne garantissons pas la possibilité de combiner des carrelages de sol de différentes épaisseurs et un carrelage de sol avec une pièce spéciale.
Die in der Tabelle angegebenen Gewichte können aus Produktionsgründen geringfügigen Abweichungen unterliegen.

Non si garantisce l'abbinabilità tra fondi di spessori diversi e tra fondo e pezzo speciale.
It is not guaranteed that background tiles with different thicknesses can be used together, nor is it guaranteed for background tiles and trims.
Nous ne garantissons pas la possibilité de combiner des carrelages de sol de différentes épaisseurs et un carrelage de sol avec une pièce spéciale.
Die Kombinierbarkeit von Fliesen unterschiedlicher Stärke sowie zwischen Fliese und Formteil kann nicht garantiert werden.

** Il peso è comprensivo dell'imballo. □ Naturale e rettificato.
The total weight includes the packaging. Natural rectified.
Le poids comprend aussi l'emballage. Naturel et rectifié.
Das Gesamtgewicht enthält auch die Verpackung. Natur Oberfläche und rektifiziert.

Per maggiori informazioni su imballi e codici articolo consultare la Sezione Tecnica: "Pezzi speciali per esterno" e "Pezzi speciali per piscina".
For more information on packaging and item codes, please refer to the Technical Section: "Special pieces for outdoor" and "Special pieces for swimming pools".
Pour plus d'informations sur les emballages et les codes articles, vous pouvez consulter la Section Technique: "Pièces spéciales pour extérieur" et "Pièces spéciales pour piscines".
Weitere Informationen für Verpackungen und Artikelcodes finden Sie im Technischen Abschnitt: "Formteile für Außenbereich" und "Formteile für Schwimmbad".



Supporti per pavimentazioni sopraelevate nella Sezione "Posa sopraelevata".
Supports for raised paving system, please refer to the Section: "Raised Laying".
Supports pour le système de carrelage surélevé dans la Section "Pose surélevée".
Stelzlagern für Doppelboden Wire im Abschnitt "Verlegung auf Stelzlagern".

* A disposizione solo su richiesta. Tempi di consegna 30 gg.
Available upon request only. Delivery terms: 30 days.
Disponibile seulement sur requête. Délais de livraison: 30 jours.
Verfügbar auf Anfrage. Lieferzeit: 30 Tage.

Costa retta.
Straight edge.
Bord droit.
Gerade Kante.

Costa toro.
Bullnose edge.
Bord boudin.
Abgerundete Kante.

ILCOTTOTAGINA

Una collezione forte ed intrigante, in stile grunge, ispirata da "cotti" oramai centenari tipici della zona del centro Italia. **ILCOTTOTAGINA** è un progetto caratterizzato da un'accurata attività di ricerca dove ogni faccia è stata creata su misura, con tonalità calibrate per realizzare una leggera stonalizzazione e per dar luogo ad ambienti non solo classici ma anche moderni con uno stile inusuale.

Quattro toni caldi, accoglienti e delicati, che si adattano a qualsiasi spazio indoor e outdoor, in stile classico e moderno grazie anche al grande formato 90x90 disponibile fino al 30 mm di spessore.

An intriguing collection with high visual impact and a grunge mood, inspired by the hundred-year-old terracotta tiles traditionally found in Central Italy. Created from thorough research activity, the **ILCOTTOTAGINA** collection features bespoke surfaces with careful calibrated shades and varying tonal intensities, designed for both classic and contemporary settings with an eclectic feel.

Four warm, welcoming, subtle colour options, suitable for any indoor and outdoor space, are ideal for classic designs, with a contemporary twist added through the large 90x90 slab available in thicknesses of up to 30 mm thick.

Une collection forte et intrigante, dans le style grunge, inspirée des « cottes » désormais centenaires, typiques du centre de l'Italie. **ILCOTTOTAGINA** est un projet caractérisé par une recherche minutieuse où chaque face a été réalisé sur mesure, avec des nuances calibrées pour créer une légère stonalisation et donner naissance à des espaces classiques et modernes avec un style inhabituel. Quatre tons chauds, doux et délicats qui s'adaptent à tout espace intérieur ou extérieur, dans un style classique ou moderne, grâce aussi au grand format 90x90 disponible jusqu'à 30 mm d'épaisseur.

Eine starke und faszinierende Kollektion im Grunge-Stil, die von den nunmehr hundert Jahre alten, für Mittelitalien typischen „Tonfliesen“ inspiriert wird. **ILCOTTOTAGINA** ist ein Projekt, das durch eine sorgfältige Forschungstätigkeit gekennzeichnet ist bei der jede Seite nach Maß erstellt wurde. Die Farbtöne sind so rektifiziert, dass sie eine leichte Schattierung entstehen lassen und Umgebungen schaffen, die nicht nur klassisch, sondern auch modern sind und einen ungewöhnlichen Stil aufweisen.

Vier warme, einladende und zarte Töne, die sich auch dank des großen Formats von 90x90, das bis zu einer Stärke von 30 mm erhältlich ist, sowohl im klassischen als auch im modernen Stil jedem Innen- und Außenbereich anpassen.

100% Made in Italy



GREY 90x90 Nat. Ret.
GREY Déco Stencil 90x90 Nat. Ret.



RIVESTIMENTO - WALL
NATURAL 30x60 Nat. Ret.
NATURAL 30x60 Déco Painted Nat. Ret.

PAVIMENTO - FLOOR
NATURAL 60x60 Nat. Ret.



NATURAL 90x90 Nat. Ret.
NATURAL 90x90 Déco Stencil Nat. Ret.



CLEAR 90x90 20 mm Nat. Ret. R11
CLEAR 90x90 Déco Painted 20 mm Nat. Ret. R11

FORMATI

Sizes / Formats / Formate

10 mm . 90x90 - 35 1/2"x35 1/2" / 60x60 - 24"x24" / 30x60 - 12"x24"
10 mm R11 . 90x90 - 35 1/2"x35 1/2"
20 mm R11 . 90x90 - 35 1/2"x35 1/2" / 60x60 - 24"x24"
30 mm R11 . 90x90 - 35 1/2"x35 1/2"

COLORI

Colours / Couleurs / Farben



NATURAL



CLEAR



RED

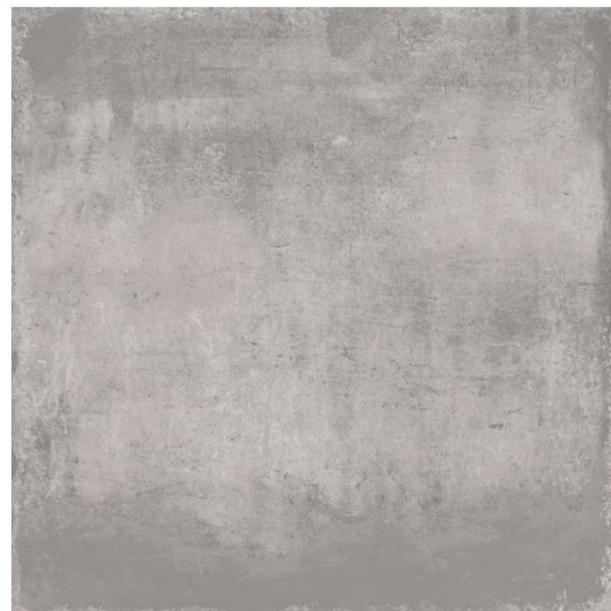

GREY

CONTINUITÀ PROGETTUALE INDOOR-OUTDOOR

Design continuity indoors and out / Continuité conceptuelle à l'intérieur et à l'extérieur / Entwurfskontinuität im innen-und Aussenbereich



INDOOR

Soluzioni contemporanee per l'interior design
 Contemporary solutions for interior design.
 Solutions contemporaines pour le design intérieur.
 Zeitgemäße Lösungen für das Interior Design.



OUTDOOR

Versatilità e prestazioni per la progettazione in esterna
 Versatility and performance for outdoor design.
 Polyvalence et performance pour l'aménagement extérieur.
 Vielseitigkeit und Leistungen für Outdoor-Design.

SISTEMI DI POSA

Laying systems / Systemes de pose / Verlegearten

Posa su erba
 Laying on grass
 Pose sur l'herbe
 Verlegung auf Wiese



Posa su sabbia
 Laying on sand
 Pose sur sable
 Verlegung auf Sand



Posa sopraelevata
 Raised laying
 Pose surélevée
 Verlegung auf Stelzlagern



Posa su ghiaia
 Laying on gravel
 Pose sur gravier
 Verlegung auf Kies



Posa tradizionale
 Standard laying
 Pose traditionnelle
 Herkömmliche Verlegung

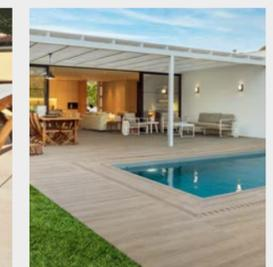

Spessore . Thickness . Epaisseur . Stärke - 10 mm

Gres porcellanato colorato in massa. Full-body coloured porcelain stoneware. Grès cérame coloré dans la masse. In der Masse gefärbtes Feinsteinzeug.

DECORI

Decors / Décors / Dekore

I N D O O R

DECO PAINTED

30x60 - 12"x24"

Fino a 12 grafiche . Up to 12 graphics. Jusqu'à 12 graphismes. Bis zum 12 Grafiken



DECO PAINTED NATURAL



DECO PAINTED CLEAR



DECO PAINTED RED



DECO PAINTED GREY

DECO STENCIL

90x90 - 35 1/2"x35 1/2"

Fino a 4 grafiche . Up to 4 graphics. Jusqu'à 4 graphismes. Bis zum 4 Grafiken



DECO STENCIL NATURAL



DECO STENCIL CLEAR



DECO STENCIL RED



DECO STENCIL GREY

Spessore . Thickness . Epaisseur . Stärke - 20 mm R11

Gres porcellanato colorato in massa. Full-body coloured porcelain stoneware. Grès cérame coloré dans la masse. In der Masse gefärbtes Feinsteinzeug.

O U T D O O R

DECO PAINTED

20 mm R11 . 90x90 - 35 1/2"x35 1/2"

Fino a 4 grafiche . Up to 4 graphics. Jusqu'à 4 graphismes. Bis zum 4 Grafiken



DECO PAINTED NATURAL



DECO PAINTED CLEAR



DECO PAINTED RED



DECO PAINTED GREY

20 mm R11 . 60x60 - 24"x24"

Fino a 6 grafiche . Up to 6 graphics. Jusqu'à 6 graphismes. Bis zum 6 Grafiken



DECO PAINTED NATURAL



DECO PAINTED CLEAR



DECO PAINTED RED

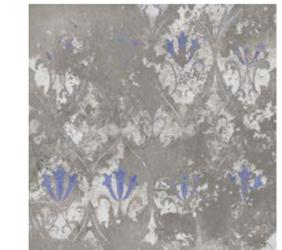

DECO PAINTED GREY

DECO STENCIL

20 mm R11 . 90x90 - 35 1/2"x35 1/2"

Fino a 4 grafiche . Up to 4 graphics. Jusqu'à 4 graphismes. Bis zum 4 Grafiken



DECO STENCIL NATURAL



DECO STENCIL CLEAR



DECO STENCIL RED



DECO STENCIL GREY

20 mm R11 . 60x60 - 24"x24"

Fino a 4 grafiche . Up to 4 graphics. Jusqu'à 4 graphismes. Bis zum 4 Grafiken



DECO STENCIL NATURAL



DECO STENCIL CLEAR



DECO STENCIL RED



DECO STENCIL GREY

Spessore . Thickness . Epaisseur . Stärke - 10 mm

Gres porcellanato colorato in massa. Full-body coloured porcelain stoneware. Grès cérame coloré dans la masse. In der Masse gefärbtes Feinsteinzeug.

INDOOR

TABELLA RIEPILOGATIVA
Summary table
Tableau récapitulatif
Zusammenfassenden Tabelle

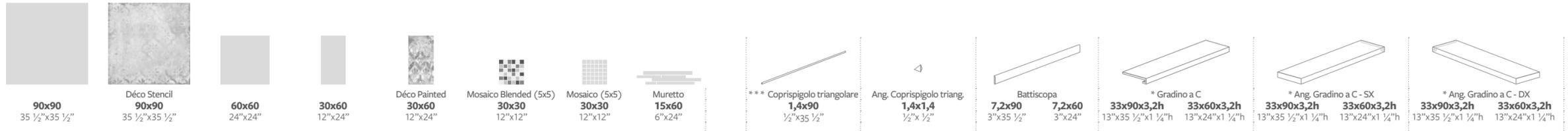

SPESSORE - THICKNESS - EPAISSEUR - STÄRKE		10 mm	10 mm	10 mm	10 mm	10 mm	10 mm	10 mm	10 mm	10 mm	10 mm	10 mm	10 mm	10 mm	10 mm	10 mm	10 mm	10 mm	10 mm
	NATURAL <input type="checkbox"/> Nat. Ret.	116041	116037	116095	116158	116162	116166	116168	116220	116230	116235	116250	116240	116278	116260	116290	116272	116284	116266
	CLEAR <input type="checkbox"/> Nat. Ret.	116044	116039	116097	116160	116164		116170	116221	116231	116236	116251	116241	116279	116261	116291	116273	116285	116267
	RED <input type="checkbox"/> Nat. Ret.	116040	116036	116094	116157	116161		116167	116222	116232	116237	116252	116242	116280	116262	116292	116274	116286	116268
	GREY <input type="checkbox"/> Nat. Ret.	116042	116038	116096	116159	116163		116169	116223	116233	116238	116253	116243	116281	116263	116293	116275	116287	116269
IMBALLI - PACKAGING EMBALLAGE - VERPACKUNG																			
		Pallet	Pallet	Pallet	Pallet	Pallet	Pallet	Pallet	Pallet			Pallet	Pallet	Pallet	Pallet	Pallet	Pallet	Pallet	Pallet
		94x120	94x120	80x120	80x120	80x120	80x120	80x120	80x120			80x120	80x120	80x120	80x120	80x120	80x120	80x120	80x120
N°																			
m²																			
Kg																			
x		2	2	3	7	7	11	11	3	6		8	14	2	4	1	2	1	2
m² x		1,62	1,62	1,08	1,26	1,26	0,99	0,99	0,27										
Kg x		37	37	24	28	28	20,5	20,5	6	2		11	11,7	21	22	10,5	11	10,5	11
x		20	20	40	40	40													
m² x		32,4	32,4	43,2	50,4	50,4													
** Kg x		760	760	980	1140	1140													
h x		64	64	75	75	75													
Imballo (tara) - Packaging (tare)		(20)	(20)	(20)	(20)	(20)	(20)	(20)	(20)			(20)	(20)	(20)	(20)	(20)	(20)	(20)	(20)

Il mosaico "Blended" è composto da un mix di tessere sia dei 4 colori della collezione che del decoro Déco Painted, disposte in modo casuale.
The Blended mosaic is made up of a mix of tiles both in the 4 colours of the collection and in the Déco Painted decor, arranged randomly.
La mosaïque Blended est composée d'un mélange de carreaux dans les 4 couleurs de la collection et dans le décor Déco Painted, disposés de manière aléatoire.
Das Blended-Mosaik besteht aus einem Kachelmix aus den 4 Farben der Kollektion und dem Dekor Déco Painted, die in einer kausalen Weise angeordnet sind.

I pesi riportati in tabella sono indicativi e potrebbero essere soggetti a leggere variazioni.
The weights stated in the chart may undergo slight changes for production reasons.
Les poids indiqués dans le tableau peuvent subir de légères variations pour des raisons de production.
Die in der Tabelle angegebenen Gewichte können aus Produktionsrunden geringfügigen Abweichungen unterliegen.

Non si garantisce l'abbinabilità tra fondi di spessori diversi e tra fondo e pezzo speciale.
It is not guaranteed that background tiles with different thicknesses can be used together, nor is it guaranteed for background tiles and trims.
Nous ne garantissons pas la possibilité de combiner des carrelages de sol de différentes épaisseurs et un carrelage de sol avec une pièce spéciale.
Die Kombinierbarkeit von Fliesen unterschiedlicher Stärke sowie zwischen Fliese und Formteil kann nicht garantiert werden.

* A disposizione solo su richiesta. Tempi di consegna 30 gg.
Available upon request only. Delivery terms: 30 days.
Disponibile seulement sur requête. Délais de livraison: 30 jours.
Verfügbar auf Anfrage. Lieferzeit: 30 Tage.

** Il peso è comprensivo dell'imballo.
The total weight includes the packaging.
Le poids comprend aussi l'emballage.
Das Gesamtgewicht enthält auch die Verpackung.

*** Vendita a scatola completa.
Full box sale.
Vente à la boîte complète.
Volle Kartons.

Naturale e rettificato.
Natural rectified.
Naturel et rectifié.
Natur Oberfläche und rektifiziert.

Spessore . Thickness . Epaisseur . Stärke - 10 mm R11 - 20 mm R11 - 30 mm R11

Gres porcellanato colorato in massa. Full-body coloured porcelain stoneware. Grès cérame coloré dans la masse. In der Masse gefärbtes Feinsteinzeug.

OUTDOOR

TABELLA RIEPILOGATIVA
Summary table
Tableau récapitulatif
Zusammenfassenden Tabelle



90x90
35 1/2"x35 1/2"



90x90
35 1/2"x35 1/2"



Déco Stencil
90x90
35 1/2"x35 1/2"



Déco Painted
90x90
35 1/2"x35 1/2"



60x60
24"x24"



Déco Stencil
60x60
24"x24"



Déco Painted
60x60
24"x24"



90x90
35 1/2"x35 1/2"

SPESSORE - THICKNESS - EPAISSEUR - STÄRKE		10 mm	20 mm	20 mm	20 mm	20 mm	20 mm	20 mm	30 mm	
	NATURAL R11 <input type="checkbox"/> Nat. Ret.	116020	116046	116058	116062		116107	116111	116115	116050
	CLEAR R11 <input type="checkbox"/> Nat. Ret.	116022	116048	116060	116064		116109	116113	116117	116052
	RED R11 <input type="checkbox"/> Nat. Ret.	116024	116045	116057	116061		116106	116110	116114	-
	GREY R11 <input type="checkbox"/> Nat. Ret.	116026	116047	116059	116063		116108	116112	116116	116051
IMBALLI - PACKAGING EMBALLAGE - VERPACKUNG										
		Pallet	Pallet	Pallet	Pallet		Pallet	Pallet	Pallet	Pallet
		94x120	94x94	94x94	94x94		80x120	80x120	80x120	95x95
N°										
m²										
Kg										
x		2	1	1	1		2	2	2	1
m² x		1,62	0,81	0,81	0,81		0,72	0,72	0,72	0,81
Kg x		37	37	37	37		32	32	32	55
x		20	30	30	30		32	32	32	20
m² x		32,4	24,3	24,3	24,3		23,04	23,04	23,04	16,2
** Kg x		760	1130	1130	1130		1044	1044	1044	1120
h x		64	80	80	80		75	75	75	78
Imballo (tara) - Packaging (tare)		(20)	(20)	(20)	(20)		(20)	(20)	(20)	(20)

I pesi riportati in tabella sono indicativi e potrebbero essere soggetti a leggere variazioni.
The weights stated in the chart may undergo slight changes for production reasons.
Les poids indiqués dans le tableau peuvent subir de légères variations pour des raisons de production.
Die in der Tabelle angegebenen Gewichte können aus Produktionsgründen geringfügigen Abweichungen unterliegen.

Non si garantisce l'abbinabilità tra fondi di spessori diversi e tra fondo e pezzo speciale.
It is not guaranteed that background tiles with different thicknesses can be used together, nor is it guaranteed for background tiles and trims.
Nous ne garantissons pas la possibilité de combiner des carrelages de sol de différentes épaisseurs et un carrelage de sol avec une pièce spéciale.
Die Kombinierbarkeit von Fliesen unterschiedlicher Stärke sowie zwischen Fliese und Formteil kann nicht garantiert werden.

o Nuova pallettizzazione disponibile ad esaurimento dello stock esistente.
New pallet configuration once current stock fully exhausted.
Nouvelle palettisation disponible jusqu'à épuisement du stock existant.
Neue Palettierung verfügbar solange der Vorrat reicht.

Naturale e rettificato.
Natural rectified.
Naturel et rectifié.
Natur Oberfläche und rektifiziert.

** Il peso è comprensivo dell'imballo.
The total weight includes the packaging.
Le poids comprend aussi l'emballage.
Das Gesamtgewicht enthält auch die Verpackung.

PEZZI SPECIALI PER ESTERNO 20 mm R11 - □ Nat. Ret.
Special pieces for outdoor - Pièces spéciales pour extérieur - Formteile für Aussenbereich

 * Gradone 30x90 . 12"x35 1/2" 30x60 . 12"x24"	 * Ang. Gradone - SX 30x90 . 12"x35 1/2" 30x60 . 12"x24"	 * Ang. Gradone - DX 30x90 . 12"x35 1/2" 30x60 . 12"x24"
 * Gradone grip 30x90 . 12"x35 1/2" 30x60 . 12"x24"	 * Ang. Gradone grip - SX 30x90 . 12"x35 1/2" 30x60 . 12"x24"	 * Ang. Gradone grip - DX 30x90 . 12"x35 1/2" 30x60 . 12"x24"
 * Elemento a L 33x90x4h 13"x35 1/2"x1 1/2"h	 * Elemento a L SX 33x90x4h 13"x35 1/2"x1 1/2"h	 * Elemento a L DX 33x90x4h 13"x35 1/2"x1 1/2"h

PEZZI SPECIALI PER PISCINA 20 mm R11 - □ Nat. Ret.
Special pieces for swimming pool - Pièces spéciales pour piscine - Formteile für Schwimmbad

 * Gradone bordo piscina 30x90 . 12"x35 1/2" 30x60 . 12"x24"	 * Ang. Gradone bordo piscina - SX 30x90 . 12"x35 1/2" 30x60 . 12"x24"	 * Ang. Gradone bordo piscina - DX 30x90 . 12"x35 1/2" 30x60 . 12"x24"
 * Gradone grip bordo piscina 30x90 . 12"x35 1/2" 30x60 . 12"x24"	 * Ang. Gradone grip bordo piscina - SX 30x90 . 12"x35 1/2" 30x60 . 12"x24"	 * Ang. Gradone grip bordo piscina - DX 30x90 . 12"x35 1/2" 30x60 . 12"x24"
 * Gradone svasato bordo piscina 30x90 . 12"x35 1/2" 30x60 . 12"x24"	 * Ang. Gradone svasato bordo piscina - SX 30x90 . 12"x35 1/2" 30x60 . 12"x24"	 * Ang. Gradone svasato bordo piscina - DX 30x90 . 12"x35 1/2" 30x60 . 12"x24"
 * Griglia 20x60 . 8"x24"	 * Griglia SX 20x60 . 8"x24"	 * Griglia DX 20x60 . 8"x24"

Per maggiori informazioni su imballi e codici articolo consultare la Sezione Tecnica: "Pezzi speciali per esterno" e "Pezzi speciali per piscina".
For more information on packaging and item codes, please refer to the Technical Section: "Special pieces for outdoor" and "Special pieces for swimming pools".
Pour plus d'informations sur les emballages et les codes articles, vous pouvez consulter la Section Technique: "Pièces spéciales pour extérieur" et "Pièces spéciales pour piscines".
Weitere Informationen für Verpackungen und Artikelcodes finden Sie im Technischen Abschnitt: "Formteile für Außenbereich" und "Formteile für Schwimmbad".

□ Naturale e rettificato.
Natural rectified.
Naturel et rectifié.
Natur Oberfläche und rektifiziert.

 Supporti per pavimentazioni sopraelevate nella Sezione "Posa sopraelevata".
Sopports for raised paving system, please refer to the Section: "Raised Laying".
Supports pour le système de carrelage surélevé dans la Section "Pose surélevée".
Stelzlager für Doppelboden Wäre im Abschnitt "Verlegung auf Stelzlager".

* A disposizione solo su richiesta. Tempi di consegna 30 gg.
Available upon request only. Delivery terms: 30 days.
Disponibile seulement sur requête. Délais de livraison: 30 jours.
Verfügbar auf Anfrage. Lieferzeit: 30 Tage.

┌ Costa retta.
Straight edge.
Bord droit.
Gerade Kante.

┐ Costa toro.
Bullnose edge.
Bord boudin.
Abgerundete Kante.



RED 90x90 20 mm Nat. Ret. R11
RED 90x90 Déco Stencil 20 mm Nat. Ret. R11

UMBRIA ANTICA

Un prodotto materico ad alte prestazioni estetiche e funzionali... così nasce la bellezza del manufatto che respira.

Un grès porcellanato morbido al tatto, resistente all'usura e che si esprime in una miscela di tonalità che vanno dai colori più freddi fino ai toni più caldi, sfaccettature a contrasto creano pattern unici e di grande impatto visivo. Grazie ai grandi formati la sua destinazione finale è molteplice, sia da interno che da esterno; la soluzione ideale per ambienti contemporanei dal gusto sofisticato, un materiale ricco di storia e tradizione che sa coniugare antico e moderno.

A material product with high aesthetic and functional performances... in this way the beauty of the "breathing" product comes to life.

A porcelain tile soft to the touch, wear-resistant that is expressed in a mixture of shades starting from colder colors to warmer tones, different facets create unique patterns of great visual impact. Thanks to the large sizes, its final destination is multiple, both indoor and outdoor; the ideal solution for a contemporary spaces with a sophisticated taste, a material rich in history and tradition that combines ancient and modern.

Un produit texturé aux performances esthétiques et fonctionnelles élevées... c'est ainsi que naît la beauté du produit qui respire.

Un grès cérame doux au toucher, résistant à l'usure et s'exprimant dans un mélange de nuances allant des tons les plus froids aux plus chauds, les facettes contrastées créent des motifs uniques de grand impact visuel. Grâce à ses grandes dimensions, les possibilités d'utilisation sont innombrables, tant à l'intérieur qu'à l'extérieur: c'est la solution idéale pour les espaces contemporains au goût sophistiqué, un matériau riche en histoire et en tradition qui sait allier l'ancien et le moderne.

Ein strukturiertes Produkt mit hohen ästhetischen und funktionalen Leistungsfähigkeiten... so wird die Schönheit eines "atmenden" Produkts ins Leben gerufen.

Ein keramisches Produkt mit sanfter Oberfläche und beständig gegen Abnutzung, das sich in einem Mix von kälteren bis wärmeren Farbtönen wiederfindet und einzigartige und facettenreiche Zusammensetzungen von hohem visuellem Impact wiedergeben. Dank der Großformate sind die Anwendungsbereiche vielseitig, sowohl im Indoor als auch im Outdoor; die ideale Lösung für einen modernen Lebensstil mit besonderem Geschmack, ein Material reich an Geschichte und Tradition, das Vergangenheit und Moderne eint.

100% Made in Italy







FORMATI

Sizes / Formats / Formate

10 mm . 90x90 - 35 1/2"x35 1/2" / 45x90 - 18"x35 1/2" / 60x120 - 24"x48" / 60x60 - 24"x24" / 30x60 - 12"x24"
9 mm R11 . 30,2x60,4 - 12"x24"
10 mm R11 . 45x90 - 18"x35 1/2" / 30,2x60,4 - 12"x24"
20 mm R11 . 90x90 - 35 1/2"x35 1/2" / 60x120 - 24"x48" / 60x60 - 24"x24"
30 mm R11 . 90x90 - 35 1/2"x35 1/2" / 60x60 - 24"x24"

COLORI

Colours / Couleurs / Farben



BIANCO



GRIGIO



ANTRACITE

CONTINUITÀ PROGETTUALE INDOOR-OUTDOOR

Design continuity indoors and out / Continuité conceptuelle à l'intérieur et à l'extérieur / Entwurfskontinuität im innen-und Aussenbereich



INDOOR

SPESORE
THICKNESS
10mm

Soluzioni contemporanee per l'interior design
 Contemporary solutions for interior design.
 Solutions contemporaines pour le design intérieur.
 Zeitgemäße Lösungen für das Interior Design.



R11
A+B+C

OUTDOOR

SPESORE
THICKNESS
9/10mm
SPESORE
THICKNESS
20mm
SPESORE
THICKNESS
30mm

Versatilità e prestazioni per la progettazione in esterna
 Versatility and performance for outdoor design.
 Polyvalence et performance pour l'aménagement extérieur.
 Vielseitigkeit und Leistungen für Outdoor-Design.

SISTEMI DI POSA

Laying systems / Systemes de pose / Verlegearten

Posa su erba
 Laying on grass
 Pose sur l'herbe
 Verlegung auf Wiese



Posa su sabbia
 Laying on sand
 Pose sur sable
 Verlegung auf Sand



Posa sopraelevata
 Raised laying
 Pose surélevée
 Verlegung auf Stelzlagern



Posa su ghiaia
 Laying on gravel
 Pose sur gravier
 Verlegung auf Kies



Posa tradizionale
 Standard laying
 Pose traditionnelle
 Herkömmliche Verlegung



Spessore . Thickness . Epaisseur . Stärke - 10 mm

Gres porcellanato colorato in massa. Full-body coloured porcelain stoneware. Grès cérame coloré dans la masse. In der Masse gefärbtes Feinsteinzeug.

INDOOR

TABELLA RIEPILOGATIVA
Summary table
Tableau récapitulatif
Zusammenfassenden Tabelle

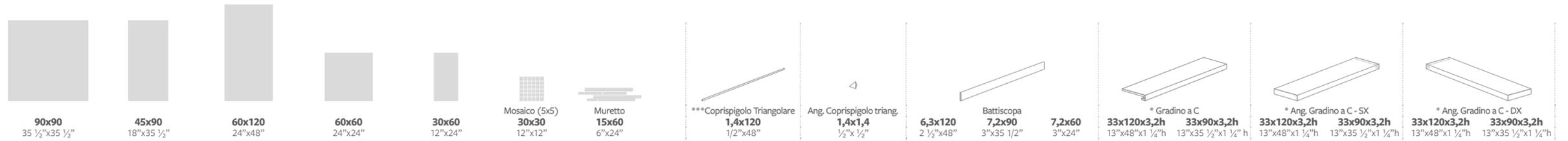

SPESSORE - THICKNESS - EPAISSEUR - STÄRKE		10 mm	10 mm	10 mm	10 mm	10 mm	10 mm	10 mm	10 mm	10 mm	10 mm	10 mm	10 mm	10 mm	10 mm	10 mm	10 mm	10 mm	
	BIANCO <input type="checkbox"/> Nat. Ret.	114030	114118	114112	114095	114160	114230	114236	114247	114250	114256	114253	114250	114268	114259	114274	114265	114271	114262
	GRIGIO <input type="checkbox"/> Nat. Ret.	114029	114117	114110	114094	114159	114231	114237	114248	114251	114257	114254	114251	114269	114260	114275	114266	114272	114263
	ANTRACITE <input type="checkbox"/> Nat. Ret.	114031	114119	114114	114096	114161	114232	114238	114249	114252	114258	114255	114252	114270	114261	114276	114267	114273	114264
IMBALLI - PACKAGING EMBALLAGE - VERPACKUNG																			
		Pallet	Pallet	Pallet	Pallet	Pallet	Pallet	Pallet			Pallet	Pallet	Pallet	Pallet	Pallet	Pallet	Pallet	Pallet	Pallet
		94x120	94x120	94x120	80x120	80x120	80x120	80x120			80x120	80x120	80x120	80x120	80x120	80x120	80x120	80x120	80x120
N°																			
m²																			
** Kg																			
		2	3	2	3	6	11	3	6		9	8	14	2	2	1	1	1	1
m² x		1,62	1,22	1,44	1,08	1,08	0,99	0,27											
Kg x		37	27	32	24	24	20,5	6	2		14,9	11	11,7	23	16,5	11,5	10,5	11,5	10,5
		30	30	36	40	40													
m² x		48,6	36,6	51,84	43,2	43,2													
** Kg x		1130	830	1172	980	980													
h x		105	60	75	75	75													
Imballo (tara) - Packaging (tare)		(20)	(20)	(20)	(20)	(20)	(20)	(20)			(20)	(20)	(20)	(20)	(20)	(20)	(20)	(20)	(20)

I pesi riportati in tabella sono indicativi e potrebbero essere soggetti a leggere variazioni.
The weights stated in the chart may undergo slight changes for production reasons.
Les poids indiqués dans le tableau peuvent subir de légères variations pour des raisons de production.
Die in der Tabelle angegebenen Gewichte können aus Produktionsgründen geringfügigen Abweichungen unterliegen.

Non si garantisce l'abbinabilità tra fondi di spessori diversi e tra fondo e pezzo speciale.
It is not guaranteed that background tiles with different thicknesses can be used together, nor is it guaranteed for background tiles and trims.
Nous ne garantissons pas la possibilité de combiner des carrelages de sol de différentes épaisseurs et un carrelage de sol avec une pièce spéciale.
Die Kombinierbarkeit von Fliesen unterschiedlicher Stärke sowie zwischen Fliese und Formteil kann nicht garantiert werden.

* A disposizione solo su richiesta. Tempi di consegna 30 gg.
Available upon request only. Delivery terms: 30 days.
Disponibile seulement sur requête. Délais de livraison: 30 jours.
Verfügbar auf Anfrage. Lieferzeit: 30 Tage.

** Il peso è comprensivo dell'imballo.
The total weight includes the packaging.
Le poids comprend aussi l'emballage.
Das Gesamtgewicht enthält auch die Verpackung.

*** Vendita a scatola completa.
Full box sale.
Vente à la boîte complète.
Volle Kartons.

Naturale e rettificato.
Natural rectified.
Naturel et rectifié.
Natur Oberfläche und rektifiziert.

Spessore . Thickness . Epaisseur . Stärke - 9 / 10 mm R11 - 20 mm R11 - 30 mm R11

Gres porcellanato colorato in massa. Full-body coloured porcelain stoneware. Grès cérame coloré dans la masse. In der Masse gefärbtes Feinsteinzeug.

OUTDOOR

TABELLA RIEPILOGATIVA
Summary table
Tableau récapitulatif
Zusammenfassenden Tabelle

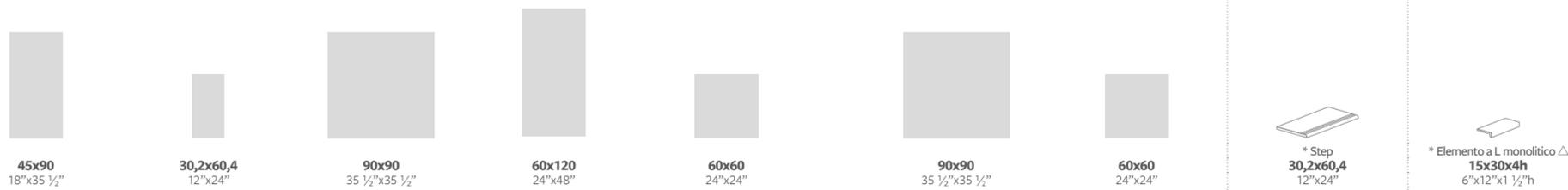

SPESSORE - THICKNESS - EPAISSEUR - STÄRKE		10 mm	▼ 9 mm	20 mm	20 mm	20 mm	20 mm	30 mm	30 mm	▼ 9 mm	9,5 mm
	□ Nat. Ret.	114120		114040	114107	114100		114190	114195		
	■ Nat. Nat.		114221							114277	114280
	□ Nat. Ret.	114121		114039	114106	114099		114187	114196		
	■ Nat. Nat.		114222							114278	114281
	□ Nat. Ret.	114122		114041	114108	114101		114186	114192		
	■ Nat. Nat.		114223							114279	114282
IMBALLI - PACKAGING EMBALLAGE - VERPACKUNG											
	Pallet	Pallet	Pallet	Pallet	Pallet	Pallet		Pallet	Pallet	Pallet	Pallet
		94x120	80x120	94x94	80x120	80x120		95x95	65x125	80x120	80x120
N°											
m²											
Kg											
	3	6	1	1	2		1	1	6	6	
m² x	1,22	1,1	0,81	0,72	0,72		0,81	0,36	1,1		
Kg x	27	22,5	37	32	32		55	25	22,5	7,50	
	30	40	30	30	32		20	44	40		
m² x	36,6	44	24,3	21,6	23,04		16,2	15,84	44		
** Kg x	830	920	1130	980	1044		1120	1116	920		
h x	60	76	80	75	75		78	84	76		
Imballo (tara) - Packaging (tare)	(20)	(20)	(20)	(20)	(20)		(20)	(16)	(20)	(20)	

I pesi riportati in tabella sono indicativi e potrebbero essere soggetti a leggere variazioni.
The weights stated in the chart may undergo slight changes for production reasons.
Les poids indiqués dans le tableau peuvent subir de légères variations pour des raisons de production.
Die in der Tabelle angegebenen Gewichte können aus Produktionsgründen geringfügigen Abweichungen unterliegen.

Non si garantisce l'abbinabilità tra fondi di spessori diversi e tra fondo e pezzo speciale.
It is not guaranteed that background tiles with different thicknesses can be used together, nor is it guaranteed for background tiles and trims.
Nous ne garantissons pas la possibilité de combiner des carrelages de sol de différentes épaisseurs et un carrelage de sol avec une pièce spéciale.
Die Kombinierbarkeit von Fliesen unterschiedlicher Stärke sowie zwischen Fliese und Formteil kann nicht garantiert werden.

▼ Gli articoli nel nuovo spessore 9 mm saranno disponibili ad esaurimento dello stock esistente in spessore 10 mm.
9 mm items will be available once the current 10 mm stock we have has run out.
Les articles de 9 mm d'épaisseur seront disponibles dès que le stock en 10 mm sera terminé.
Die 9 mm Artikel werden verfügbar sein, sobald die 10 mm Lagerbestände abverkauft sind.

○ Nuova pallettizzazione disponibile ad esaurimento dello stock esistente.
New pallet configuration once current stock fully exhausted.
Nouvelle palettisation disponible jusqu'à épuisement du stock existant.
Neue Palettierung verfügbar solange der Vorrat reicht.

* A disposizione solo su richiesta. Tempi di consegna 30 gg.
Available upon request only. Delivery terms: 30 days.
Disponible seulement sur requête. Délais de livraison: 30 jours.
Verfügbar auf Anfrage. Lieferzeit: 30 Tage.

** Il peso è comprensivo dell'imballo.
The total weight includes the packaging.
Le poids comprend aussi l'emballage.
Das Gesamtgewicht enthält auch die Verpackung.

□ Naturale e rettificato.
Natural rectified.
Naturel et rectifié.
Natur Oberfläche und rektifiziert.

■ Naturale e naturale.
Natural and natural.
Naturel et naturel.
Natur natur.

△ Monolitico
Monolithic step
Monolitico
Monolitische Stufenplatte

PEZZI SPECIALI PER ESTERNO 20 mm R11 - □ Nat. Ret.
Special pieces for outdoor - Pièces spéciales pour extérieur - Formteile für Aussenbereich

 * Gradone 30x120 . 12"x48" 30x90 . 12"x35 1/2" 30x60 . 12"x24"	 * Ang. Gradone - SX 30x120 . 12"x48" 30x90 . 12"x35 1/2" 30x60 . 12"x24"	 * Ang. Gradone - DX 30x120 . 12"x48" 30x90 . 12"x35 1/2" 30x60 . 12"x24"
 * Gradone grip 30x120 . 12"x48" 30x90 . 12"x35 1/2" 30x60 . 12"x24"	 * Ang. Gradone grip - SX 30x120 . 12"x48" 30x90 . 12"x35 1/2" 30x60 . 12"x24"	 * Ang. Gradone grip - DX 30x120 . 12"x48" 30x90 . 12"x35 1/2" 30x60 . 12"x24"
 * Elemento a L 33x120x4h 13"x48"x1 1/2"h	 * Elemento a L SX 33x90x4h 13"x35 1/2"x1 1/2"h	 * Elemento a L DX 33x90x4h 13"x35 1/2"x1 1/2"h

PEZZI SPECIALI PER PISCINA 20 mm R11 - □ Nat. Ret.
Special pieces for swimming pool - Pièces spéciales pour piscine - Formteile für Schwimmbad

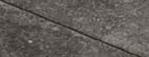
 * Gradone bordo piscina 30x120 . 12"x48" 30x90 . 12"x35 1/2" 30x60 . 12"x24"	 * Ang. Gradone bordo piscina - SX 30x120 . 12"x48" 30x90 . 12"x35 1/2" 30x60 . 12"x24"	 * Ang. Gradone bordo piscina - DX 30x120 . 12"x48" 30x90 . 12"x35 1/2" 30x60 . 12"x24"
 * Gradone grip bordo piscina 30x120 . 12"x48" 30x90 . 12"x35 1/2" 30x60 . 12"x24"	 * Ang. Gradone grip bordo piscina - SX 30x120 . 12"x48" 30x90 . 12"x35 1/2" 30x60 . 12"x24"	 * Ang. Gradone grip bordo piscina - DX 30x120 . 12"x48" 30x90 . 12"x35 1/2" 30x60 . 12"x24"
 * Gradone svasato bordo piscina 30x120 . 12"x48" 30x90 . 12"x35 1/2" 30x60 . 12"x24"	 * Ang. Gradone svasato bordo piscina - SX 30x120 . 12"x48" 30x90 . 12"x35 1/2" 30x60 . 12"x24"	 * Ang. Gradone svasato bordo piscina - DX 30x120 . 12"x48" 30x90 . 12"x35 1/2" 30x60 . 12"x24"
 * Griglia 20x60 . 8"x24"	 * Griglia SX 20x60 . 8"x24"	 * Griglia DX 20x60 . 8"x24"

Per maggiori informazioni su imballi e codici articolo consultare la Sezione Tecnica: "Pezzi speciali per esterno" e "Pezzi speciali per piscina".
For more information on packaging and item codes, please refer to the Technical Section: "Special pieces for outdoor" and "Special pieces for swimming pools".
Pour plus d'informations sur les emballages et les codes articles, vous pouvez consulter la Section Technique: "Pièces spéciales pour extérieur" et "Pièces spéciales pour piscines".
Weitere Informationen für Verpackungen und Artikelcodes finden Sie im Technischen Abschnitt: "Formteile für Außenbereich" und "Formteile für Schwimmbad".

□ Naturale e rettificato.
Natural rectified.
Naturel et rectifié.
Natur Oberfläche und rektifiziert.

 Supporti per pavimentazioni sopraelevate nella Sezione "Posa sopraelevata".
Supports for raised paving system, please refer to the Section: "Raised Laying".
Supports pour le système de carrelage surélevé dans la Section "Pose surélevée".
Stelzlagern für Doppelboden Wire im Abschnitt "Verlegung auf Stelzlagern".

* A disposizione solo su richiesta. Tempi di consegna 30 gg.
Available upon request only. Delivery terms: 30 days.
Disponibile seulement sur requête. Délais de livraison: 30 jours.
Verfügbar auf Anfrage. Lieferzeit: 30 Tage.

┃ Costa retta.
Straight edge.
Bord droit.
Gerade Kante.

┃ Costa toro.
Bullnose edge.
Bord boudin.
Abgerundete Kante.



ANTRACITE 90x90 20 mm Nat. Ret. R11

PIETRA REGALE

Il carattere sobrio e al tempo stesso deciso della Pietra di Luserna (da secoli fiore all'occhiello dell'architettura piemontese, impiegata in edifici simbolo della sua storia, dalla Reggia di Venaria alla Mole Antonelliana) rivive in **PIETRA REGALE**. Una collezione che interpreta questo nobile materiale con gusto contemporaneo e ne amplifica le potenzialità progettuali grazie alle caratteristiche uniche del grès porcellanato in termini di versatilità, resistenza e praticità. 5 colori, in 3 spessori, per un design che sa coniugare diversi contesti e destinazioni d'uso, indoor e outdoor, immagine e sostanza, tradizione e innovazione.

The sober and at the same time strong character of the Pietra di Luserna (for centuries the pride of Piemontese architecture, used in buildings that symbolize its history, from the Reggia di Venaria to the Mole Antonelliana) lives again in **PIETRA REGALE**. A series that represents this noble material with a contemporary taste and amplifies its project-planning potential thanks to the unique characteristics of porcelain tile for versatility, strength and functionality. 5 colours, in 3 thicknesses, for a design that combines different contexts and uses, indoor and outdoor, image and substance, tradition and innovation.

Le caractère à la fois sobre et décisif de la Pierre de Luserna (depuis des siècles la fierté de l'architecture piémontaise, utilisée dans des bâtiments qui sont des symboles de son histoire, de la Reggia di Venaria à la Mole Antonelliana) revit dans **PIETRA REGALE**. Une collection qui interprète ce matériau noble avec un goût contemporain et qui amplifie son potentiel de conception grâce aux caractéristiques uniques du grès cérame en termes de polyvalence, de résistance et de praticité. 5 couleurs, en 3 épaisseurs, pour un design qui sait combiner différents contextes et usages, indoor et outdoor, image et substance, tradition et innovation.

Der trockene aber gleichzeitig kräftige Charakter der Pietra di Luserna (seit Jahrhunderten Stolz der piemontesischen Architektur, in historisch symbolischen Bauten verwendet, wie die Reggia di Venaria und Mole Antonelliana) lebt in der **PIETRA REGALE** wieder auf. Eine Serie, die dieses noble Material mit modernen Charme umkleidet und dessen Anwendung für Projekte interessanter macht, dank der bekannten Eigenschaften von Feinsteinzeug wie Vielseitigkeit, Belastbarkeit und Zweckmäßigkeit. 5 Farben in 3 Stärken für ein Design, in der Lage unterschiedliche Kontexte und Anwendungsbereiche zu konjugieren, wie Indoor und Outdoor, Image und Substanz, Tradition und Innovation.

100% Made in Italy





RIVOLI 60x60 / 60 x120 Nat. Ret.



ELVA 30,2x60,4 Nat. Nat. R11
ELVA Elemento a L monolitico 15x30x4h Nat. Nat. R11



PIETRA REGALE

FORMATI

Sizes / Formats / Formate

- 10 mm . 90x90 - 35 1/2"x35 1/2" / 45x90 - 18"x35 1/2" / 60x120 - 24"x48" / 60x60 - 24"x24" / 30x60 - 12"x24"
 9 mm R11 . 30,2x60,4 - 12"x24"
 10 mm R11. 45x90 - 18"x35 1/2"
 20 mm R11. 90x90 - 35 1/2"x35 1/2" / 60x120 - 24"x48" / 60x60 - 24"x24"
 30 mm R11. 90x90 - 35 1/2"x35 1/2" / 60x60 - 24"x24"

COLORI

Colours / Couleurs / Farben



ELVA



RIVOLI

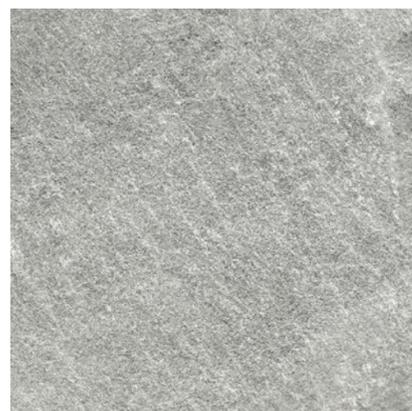

OSTANA



CHIANALE



MURAZZANO

CONTINUITÀ PROGETTUALE INDOOR-OUTDOOR

Design continuity indoors and out / Continuité conceptuelle à l'intérieur et à l'extérieur / Entwurfskontinuität im innen-und Aussenbereich



INDOOR

Soluzioni contemporanee per l'interior design
 Contemporary solutions for interior design.
 Solutions contemporaines pour le design intérieur.
 Zeitgemäße Lösungen für das Interior Design.



OUTDOOR

Versatilità e prestazioni per la progettazione in esterna
 Versatility and performance for outdoor design.
 Polyvalence et performance pour l'aménagement extérieur.
 Vielseitigkeit und Leistungen für Outdoor-Design.

SISTEMI DI POSA

Laying systems / Systemes de pose / Verlegearten

Posa su erba
 Laying on grass
 Pose sur l'herbe
 Verlegung auf Wiese



Posa su sabbia
 Laying on sand
 Pose sur sable
 Verlegung auf Sand



Posa sopraelevata
 Raised laying
 Pose surélevée
 Verlegung auf Stelzlager



Posa su ghiaia
 Laying on gravel
 Pose sur gravier
 Verlegung auf Kies



Posa tradizionale
 Standard laying
 Pose traditionnelle
 Herkömmliche Verlegung

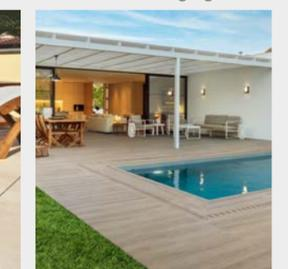

Spessore . Thickness . Epaisseur . Stärke - 10 mm

Gres porcellanato colorato in massa. Full-body coloured porcelain stoneware. Grès cérame coloré dans la masse. In der Masse gefärbtes Feinsteinzeug.

INDOOR

TABELLA RIEPILOGATIVA
Summary table
Tableau récapitulatif
Zusammenfassende Tabelle

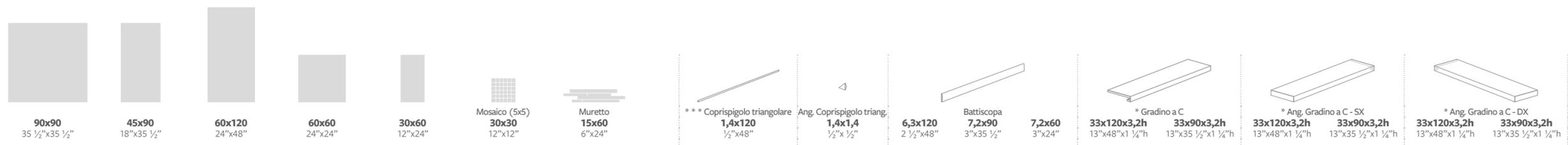

		SPESSORE - THICKNESS - EPAISSEUR - STÄRKE		10 mm		10 mm		10 mm		10 mm		10 mm		10 mm		10 mm		10 mm		10 mm	
	ELVA <input type="checkbox"/> Nat. Ret.	117072	117084	117077	117075	117112	117174	117184			117274	117275	117194	117204	117199	117214	117224	117234	117244	117254	117264
	RIVOLI <input type="checkbox"/> Nat. Ret.	117013	117083	117049	117038	117111	117173	117183			117273	117276	117193	117203	117198	117213	117223	117233	117243	117253	117263
	OSTANA <input type="checkbox"/> Nat. Ret.	117015	117082	117051	117040	117110	117172	117182			117272	117277	117192	117202	117197	117212	117222	117232	117242	117252	117262
	CHIANALE <input type="checkbox"/> Nat. Ret.	117020	117080	117056	117043	117108	117170	117180			117270	117278	117190	117200	117195	117210	117220	117230	117240	117250	117260
	MURAZZANO <input type="checkbox"/> Nat. Ret.	117017	117081	117054	117041	117109	117171	117181			117271	117279	117191	117201	117196	117211	117221	117231	117241	117251	117261
IMBALLI - PACKAGING EMBALLAGE - VERPACKUNG																					
		Pallet	Pallet	Pallet	Pallet	Pallet	Pallet	Pallet			Pallet	Pallet	Pallet	Pallet	Pallet	Pallet	Pallet	Pallet	Pallet	Pallet	Pallet
		94x120	94x120	80x120	80x120	80x120	80x120	80x120			80x120	80x120	80x120	80x120	80x120	80x120	80x120	80x120	80x120	80x120	80x120
N°																					
m²																					
** Kg																					
		2	3	2	3	6	11	3			6		9	8	14	2	2	1	1	1	1
		1,62	1,22	1,44	1,08	1,08	0,99	0,27													
		37	27	32	24	24	20,5	6			2		14,9	11	11,7	23	16,5	11,5	8,5	11,5	8,5
		30	30	30	40	40															
		48,6	36,6	43,2	43,2	43,2															
		1130	830	980	980	980															
		105	60	75	75	75															
Imballo (tara) - Packaging (tare)		(20)	(20)	(20)	(20)	(20)	(20)	(20)					(20)	(20)	(20)	(20)	(20)	(20)	(20)	(20)	(20)

I pesi riportati in tabella sono indicativi e potrebbero essere soggetti a leggere variazioni.
The weights stated in the chart may undergo slight changes for production reasons.
Les poids indiqués dans le tableau peuvent subir de légères variations pour des raisons de production.
Die in der Tabelle angegebenen Gewichte können aus Produktionsgründen geringfügigen Abweichungen unterliegen.

Non si garantisce l'abbinabilità tra fondi di spessori diversi e tra fondo e pezzo speciale.
It is not guaranteed that background tiles with different thicknesses can be used together, nor is it guaranteed for background tiles and trims.
Nous ne garantissons pas la possibilité de combiner des carrelages de sol de différentes épaisseurs et un carrelage de sol avec une pièce spéciale.
Die Kombinierbarkeit von Fliesen unterschiedlicher Stärke sowie zwischen Fliese und Formteil kann nicht garantiert werden.

© Nuova pallettizzazione disponibile ad esaurimento dello stock esistente.
New pallet configuration once current stock fully exhausted.
Nouvelle palettisation disponible jusqu'à épuisement du stock existant.
Neue Palettierung verfügbar solange der Vorrat reicht.

* A disposizione solo su richiesta. Tempi di consegna 30 gg.
Available upon request only. Delivery terms: 30 days.
Disponible seulement sur requête. Délais de livraison: 30 jours.
Verfügbar auf Anfrage. Lieferzeit: 30 Tage.

** Il peso è comprensivo dell'imballo.
The total weight includes the packaging.
Le poids comprend aussi l'emballage.
Das Gesamtgewicht enthält auch die Verpackung.

Naturale e rettificato.
Natural rectified.
Naturel et rectifié.
Natur Oberfläche und rektifiziert.

Spessore . Thickness . Epaisseur . Stärke - 9 / 10 mm R11 - 20 mm R11 - 30 mm R11

Gres porcellanato colorato in massa. Full-body coloured porcelain stoneware. Grès cérame coloré dans la masse. In der Masse gefärbtes Feinsteinzeug.

OUTDOOR

TABELLA RIEPILOGATIVA
Summary table
Tableau récapitulatif
Zusammenfassenden Tabelle

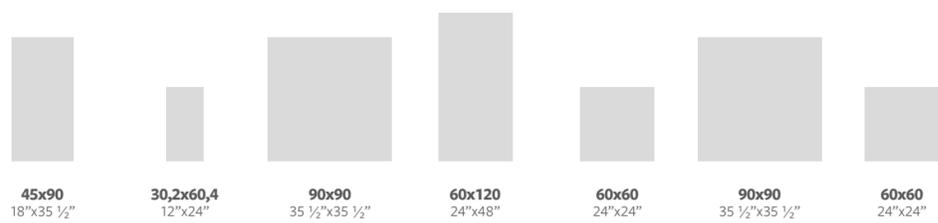

SPESSORE - THICKNESS - EPAISSEUR - STÄRKE		10 mm	▼ 9 mm	20 mm	20 mm	20 mm	30 mm	30 mm	▼ 9 mm	9,5 mm
	□ Nat. Ret.	117094		117070	117076	117073	-	-		
	■ Nat. Nat.		117103						117133	117142
	□ Nat. Ret.	117093		117001	117045	117025	117005	117029		
	■ Nat. Nat.		117102						117132	117141
	□ Nat. Ret.	117092		117002	117046	117026	117006	117030		
	■ Nat. Nat.		117101						117131	117140
	□ Nat. Ret.	117090		117004	117048	117028	117008	117032		
	■ Nat. Nat.		117099						117129	117138
	□ Nat. Ret.	117091		117003	117047	117027	117007	117031		
	■ Nat. Nat.		117100						117130	117139
IMBALLI - PACKAGING EMBALLAGE - VERPACKUNG										
		Pallet	Pallet	Pallet	Pallet	Pallet	Pallet	Pallet	Pallet	Pallet
		94x120	80x120	94x94	80x120	80x120	95x95	65x125	80x120	80x120
N°										
m ²										
Kg										
		3	8	1	1	2	1	1	8	6
m ² x		1,22	1,46	0,81	0,72	0,72	0,81	0,36	1,46	6
Kg x		27	29,2	37	32	32	55	25	29,2	7,5
		30	32	30	30	32	20	44	32	
m ² x		36,6	46,72	24,3	21,6	23,04	16,2	15,84	46,72	
** Kg x		830	954,4	1130	980	1044	1120	1116	954,4	
h x		60	76	80	75	75	78	84	76	
Imballo (tara) - Packaging (tare)		(20)	(20)	(20)	(20)	(20)	(20)	(16)	(20)	(20)

I pesi riportati in tabella sono indicativi e potrebbero essere soggetti a leggere variazioni.
The weights stated in the chart may undergo slight changes for production reasons.
Les poids indiqués dans le tableau peuvent subir de légères variations pour des raisons de production.
Die in der Tabelle angegebenen Gewichte können aus Produktionsgründen geringfügigen Abweichungen unterliegen.

Non si garantisce l'abbinabilità tra fondi di spessori diversi e tra fondo e pezzo speciale.
It is not guaranteed that background tiles with different thicknesses can be used together, nor is it guaranteed for background tiles and trims.
Nous ne garantissons pas la possibilité de combiner des carrelages de sol de différentes épaisseurs et un carrelage de sol avec une pièce spéciale.
Die Kombinierbarkeit von Fliesen unterschiedlicher Stärke sowie zwischen Fliese und Formteil kann nicht garantiert werden.

▼ Gli articoli nel nuovo spessore 9 mm saranno disponibili ad esaurimento dello stock esistente in spessore 10 mm.
9 mm items will be available once the current 10 mm stock we have has run out.
Les articles de 9 mm d'épaisseur seront disponibles dès que le stock en 10 mm sera terminé.
Die 9 mm Artikel werden verfügbar sein, sobald die 10 mm Lagerbestände abverkauft sind.

○ Nuova pallettizzazione disponibile ad esaurimento dello stock esistente.
New pallet configuration once current stock fully exhausted.
Nouvelle palettisation disponible jusqu'à épuisement du stock existant.
Neue Palettierung verfügbar solange der Vorrat reicht.

* A disposizione solo su richiesta. Tempi di consegna 30 gg.
Available upon request only. Delivery terms: 30 days.
Disponible seulement sur requête. Délais de livraison: 30 jours.
Verfügbar auf Anfrage. Lieferzeit: 30 Tage.

** Il peso è comprensivo dell'imballo.
The total weight includes the packaging.
Le poids comprend aussi l'emballage.
Das Gesamtgewicht enthält auch die Verpackung.

□ Naturale e rettificato.
Natural rectified.
Naturel et rectifié.
Natur Oberfläche und rektifiziert.

■ Naturale e naturale.
Natural and natural.
Naturel et naturel.
Natur natur.

△ Monolitico
Monolithic step
Monolitico
Monolitische Stufenplatte

PEZZI SPECIALI PER ESTERNO 20 mm R11 - □ Nat. Ret.
Special pieces for outdoor - Pièces spéciales pour extérieur - Formteile für Aussenbereich

	* Gradone		* Ang. Gradone - SX		* Ang. Gradone - DX
30x120 . 12"x48"	30x90 . 12"x35 1/2"	30x60 . 12"x24"	30x120 . 12"x48"	30x90 . 12"x35 1/2"	30x60 . 12"x24"
	* Gradone grip		* Ang. Gradone grip - SX		* Ang. Gradone grip - DX
30x120 . 12"x48"	30x90 . 12"x35 1/2"	30x60 . 12"x24"	30x120 . 12"x48"	30x90 . 12"x35 1/2"	30x60 . 12"x24"
	* Elemento a L		* Elemento a L SX		* Elemento a L DX
33x120x4h 13"x48"x1 1/2"h	33x90x4h 13"x35 1/2"x1 1/2"h	33x60x4h 13"x24"x1 1/2"h	33x120x4h 13"x48"x1 1/2"h	33x90x4h 13"x35 1/2"x1 1/2"h	33x60x4h 13"x24"x1 1/2"h

PEZZI SPECIALI PER PISCINA 20 mm R11 - □ Nat. Ret.
Special pieces for swimming pool - Pièces spéciales pour piscine - Formteile für Schwimmbad

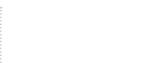
	* Gradone bordo piscina		* Ang. Gradone bordo piscina - SX		* Ang. Gradone bordo piscina - DX
30x120 . 12"x48"	30x90 . 12"x35 1/2"	30x60 . 12"x24"	30x120 . 12"x48"	30x90 . 12"x35 1/2"	30x60 . 12"x24"
	* Gradone grip bordo piscina		* Ang. Gradone grip bordo piscina - SX		* Ang. Gradone grip bordo piscina - DX
30x120 . 12"x48"	30x90 . 12"x35 1/2"	30x60 . 12"x24"	30x120 . 12"x48"	30x90 . 12"x35 1/2"	30x60 . 12"x24"
	* Gradone svasato bordo piscina		* Ang. Gradone svasato bordo piscina - SX		* Ang. Gradone svasato bordo piscina - DX
30x120 . 12"x48"	30x90 . 12"x35 1/2"	30x60 . 12"x24"	30x120 . 12"x48"	30x90 . 12"x35 1/2"	30x60 . 12"x24"
	* Griglia		* Griglia SX		* Griglia DX
20x60 . 8"x24"		20x60 . 8"x24"		20x60 . 8"x24"	

Per maggiori informazioni su imballi e codici articolo consultare la Sezione Tecnica: "Pezzi speciali per esterno" e "Pezzi speciali per piscina".
For more information on packaging and item codes, please refer to the Technical Section: "Special pieces for outdoor" and "Special pieces for swimming pools".
Pour plus d'informations sur les emballages et les codes articles, vous pouvez consulter la Section Technique: "Pièces spéciales pour extérieur" et "Pièces spéciales pour piscines".
Weitere Informationen für Verpackungen und Artikelcodes finden Sie im Technischen Abschnitt: "Formteile für Außenbereich" und "Formteile für Schwimmbad".

□ Naturale e rettificato.
Natural rectified.
Naturel et rectifié.
Natur Oberfläche und rektifiziert.

 Supporti per pavimentazioni sopraelevate nella Sezione "Posa sopraelevata".
Supports for raised paving system, please refer to the Section: "Raised Laying".
Supports pour le système de carrelage surélevé dans la Section "Pose surélevée".
Stelzlager für Doppelboden Wire im Abschnitt "Verlegung auf Stelzlager".

* A disposizione solo su richiesta. Tempi di consegna 30 gg.
Available upon request only. Delivery terms: 30 days.
Disponibile seulement sur requête. Délais de livraison: 30 jours.
Verfügbar auf Anfrage. Lieferzeit: 30 Tage.

┃ Costa retta.
Straight edge.
Bord droit.
Gerade Kante.

┃ Costa toro.
Bullnose edge.
Bord boudin.
Abgerundete Kante.



OSTANA 60x120 20-mm Nat. Ret. R11

DEEP BLUE

La collezione **DEEP BLUE** si ispira alla pietra naturale del Belgio, la Pierre Blue il cui nome deriva dal suo colore particolare di grigiocombinato a tonalità di blu che virano sia ai toni più scuri del nero, sia ai toni più chiari del bianco. La collezione presentata in 2 nuance di grigio, è disponibile dai formati 120x120 fino al 60x60, nello spessore 20 mm nella versione outdoor.

The **DEEP BLUE** collection is inspired by the Pierre Bleue, a stone native to Belgium which takes its name from its unusual blend of greys and blues, which range from darkest black to pale, almost white, shades. Available in two shades of grey, the collection comes in sizes 60x60 up to 120x120 in 20 mm thickness in the non-slip version.

La collection **DEEP BLUE** s'inspire de la pierre naturelle de Belgique, la Pierre Bleue, dont le nom vient de sa couleur grise particulière combinée à des nuances de bleu qui virent à des tons plus sombres de noir et à des tons plus clairs de blanc. La collection, présentée en 2 nuances de gris, est disponible dans des formats allant de 120x120 à 60x60 cm, en épaisseur 20 mm dans la version antidérapante.

Die Kollektion **DEEP BLUE** wird vom belgischen Naturstein Pierre Blue inspiriert, dessen Name von seiner besonderen Grautönung in Kombination mit Blautönen stammt, die sowohl von den dunkelsten Tönen des Schwarz als auch bis zu den hellsten Tönen des Weiß reichen. Die Kollektion, die in 2 Grau-Nuancen präsentiert wird, ist in den Formaten 120x120 bis 60x60 in den Stärken 20 mm in der rutschfesten Version erhältlich.

100% Made in Italy

DEEP BLUE

FORMATI

Sizes / Formats / Formate

20 mm R11. 120x120 - 48"x48" / 90x90 - 35 1/2"x35 1/2" / 60x60 - 24"x24"

COLORI

Colours / Couleurs / Farben



GRIGIO

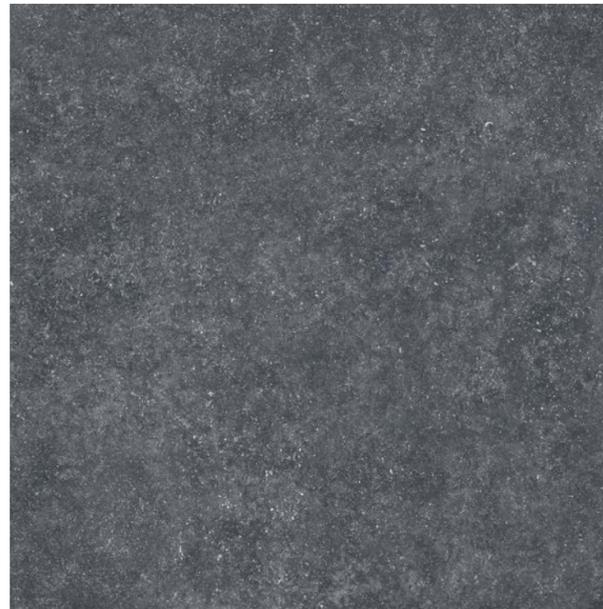

ANTRACITE

CONTINUITÀ PROGETTUALE INDOOR-OUTDOOR

Design continuity indoors and out / Continuité conceptuelle à l'intérieur et à l'extérieur / Entwurfskontinuität im innen-und Aussenbereich



OUTDOOR

Versatilità e prestazioni per la progettazione in esterna
Versatility and performance for outdoor design.
Polyvalence et performance pour l'aménagement extérieur.
Vielseitigkeit und Leistungen für Outdoor-Design.

SISTEMI DI POSA

Laying systems / Systemes de pose / Verlegearten

Posa su erba
Laying on grass
Pose sur l'herbe
Verlegung auf Wiese



Posa su sabbia
Laying on sand
Pose sur sable
Verlegung auf Sand



Posa sopraelevata
Raised laying
Pose surélevée
Verlegung auf Stelzlagern



Posa su ghiaia
Laying on gravel
Pose sur gravier
Verlegung auf Kies



Posa tradizionale
Standard laying
Pose traditionnelle
Herkömmliche Verlegung



Spessore . Thickness . Epaisseur . Stärke - 20 mm R11

Gres porcellanato colorato in massa. Full-body coloured porcelain stoneware. Grès cérame coloré dans la masse. In der Masse gefärbtes Feinsteinzeug.

OUTDOOR

TABELLA RIEPILOGATIVA
Summary table
Tableau récapitulatif
Zusammenfassenden Tabelle

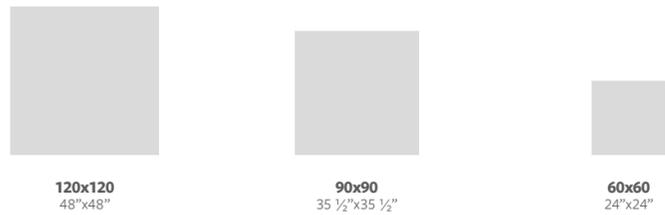

SPESORE - THICKNESS - EPAISSEUR - STÄRKE	20 mm	20 mm	20 mm
GRIGIO R11 □ Nat. Ret.	120031	120001	120014
ANTRACITE R11 □ Nat. Ret.	120032	120002	120015
IMBALLI - PACKAGING EMBALLAGE - VERPACKUNG			
	Pallet	Pallet	Pallet
	123x144	94x94	80x120
N°			
m²			
Kg			
x	1	1	2
m² x	1,44	0,81	0,72
Kg x	64	37	32
x	18	24	32
m² x	25,92	19,44	23,04
** Kg x	1205	908	1044
h x	65	74	75
Imballo (tara) - Packaging (tare)	(53)	(20)	(20)

PEZZI SPECIALI PER ESTERNO 20 mm R11 - □ Nat. Ret.
Special pieces for outdoor - Pièces spéciales pour extérieur - Formteile für Aussenbereich

<td> <td> <td> <td> <td> </td></td></td></td></td>	<td> <td> <td> <td> </td></td></td></td>	<td> <td> <td> </td></td></td>	<td> <td> </td></td>	<td> </td>							
		* Gradone						* Ang. Gradone - SX			
<td> <td> <td> <td> <td> </td></td></td></td></td>	<td> <td> <td> <td> </td></td></td></td>	<td> <td> <td> </td></td></td>	<td> <td> </td></td>	<td> </td>							
		* Gradone grip						* Ang. Gradone grip - SX			
<td> <td> <td> <td> <td> </td></td></td></td></td>	<td> <td> <td> <td> </td></td></td></td>	<td> <td> <td> </td></td></td>	<td> <td> </td></td>	<td> </td>							
		* Elemento a L						* Elemento a L SX			
<td> <td> <td> <td> <td> </td></td></td></td></td>	<td> <td> <td> <td> </td></td></td></td>	<td> <td> <td> </td></td></td>	<td> <td> </td></td>	<td> </td>							
		* Gradone bordo piscina						* Ang. Gradone bordo piscina - SX			
<td> <td> <td> <td> <td> </td></td></td></td></td>	<td> <td> <td> <td> </td></td></td></td>	<td> <td> <td> </td></td></td>	<td> <td> </td></td>	<td> </td>							
		* Gradone grip bordo piscina						* Ang. Gradone grip bordo piscina - SX			
<td> <td> <td> <td> <td> </td></td></td></td></td>	<td> <td> <td> <td> </td></td></td></td>	<td> <td> <td> </td></td></td>	<td> <td> </td></td>	<td> </td>							
		* Gradone svasato bordo piscina						* Ang. Gradone svasato bordo piscina - SX			
<td> <td> <td> <td> <td> </td></td></td></td></td>	<td> <td> <td> <td> </td></td></td></td>	<td> <td> <td> </td></td></td>	<td> <td> </td></td>	<td> </td>							
		* Griglia						* Griglia SX			
<td> <td> <td> <td> <td> </td></td></td></td></td>	<td> <td> <td> <td> </td></td></td></td>	<td> <td> <td> </td></td></td>	<td> <td> </td></td>	<td> </td>							
		* Griglia DX						* Griglia DX			

PEZZI SPECIALI PER PISCINA 20 mm R11 - □ Nat. Ret.
Special pieces for swimming pool - Pièces spéciales pour piscine - Formteile für Schwimmbad

<td> <td> <td> <td> <td> </td></td></td></td></td>	<td> <td> <td> <td> </td></td></td></td>	<td> <td> <td> </td></td></td>	<td> <td> </td></td>	<td> </td>							
		* Gradone bordo piscina						* Ang. Gradone bordo piscina - SX			
<td> <td> <td> <td> <td> </td></td></td></td></td>	<td> <td> <td> <td> </td></td></td></td>	<td> <td> <td> </td></td></td>	<td> <td> </td></td>	<td> </td>							
		* Gradone grip bordo piscina						* Ang. Gradone grip bordo piscina - SX			
<td> <td> <td> <td> <td> </td></td></td></td></td>	<td> <td> <td> <td> </td></td></td></td>	<td> <td> <td> </td></td></td>	<td> <td> </td></td>	<td> </td>							
		* Gradone svasato bordo piscina						* Ang. Gradone svasato bordo piscina - SX			
<td> <td> <td> <td> <td> </td></td></td></td></td>	<td> <td> <td> <td> </td></td></td></td>	<td> <td> <td> </td></td></td>	<td> <td> </td></td>	<td> </td>							
		* Griglia						* Griglia SX			
<td> <td> <td> <td> <td> </td></td></td></td></td>	<td> <td> <td> <td> </td></td></td></td>	<td> <td> <td> </td></td></td>	<td> <td> </td></td>	<td> </td>							
		* Griglia DX						* Griglia DX			

○ Nuova pallettizzazione disponibile ad esaurimento dello stock esistente.
New pallet configuration once current stock fully exhausted.
Nouvelle palettisation disponible jusqu'à épuisement du stock existant.
Neue Palettierung verfügbar solange der Vorrat reicht.

I pesi riportati in tabella sono indicativi e potrebbero essere soggetti a leggere variazioni.
The weights stated in the chart may undergo slight changes for production reasons.
Les poids indiqués dans le tableau peuvent subir de légères variations pour des raisons de production.
Die in der Tabelle angegebenen Gewichte können aus Produktionsgründen geringfügigen Abweichungen unterliegen.

Non si garantisce l'abbinabilità tra fondi di spessori diversi e tra fondo e pezzo speciale.
It is not guaranteed that background tiles with different thicknesses can be used together, nor is it guaranteed for background tiles and trims.
Nous ne garantissons pas la possibilité de combiner des carrelages de sol de différentes épaisseurs et un carrelage de sol avec une pièce spéciale.
Die Kombinierbarkeit von Fliesen unterschiedlicher Stärke sowie zwischen Fliese und Formteil kann nicht garantiert werden.

** Il peso è comprensivo dell'imballo.
The total weight includes the packaging.
Le poids comprend aussi l'emballage.
Das Gesamtgewicht enthält auch die Verpackung.

Per maggiori informazioni su imballi e codici articolo consultare la Sezione Tecnica: "Pezzi speciali per esterno" e "Pezzi speciali per piscina".
For more information on packaging and item codes, please refer to the Technical Section: "Special pieces for outdoor" and "Special pieces for swimming pools".
Pour plus d'informations sur les emballages et les codes articles, vous pouvez consulter la Section Technique: "Pièces spéciales pour extérieur" et "Pièces spéciales pour piscines".
Weitere Informationen für Verpackungen und Artikelcodes finden Sie im Technischen Abschnitt: "Formteile für Außenbereich" und "Formteile für Schwimmbad".



Supporti per pavimentazioni sopraelevate nella Sezione "Posa sopraelevata".
Sopports for raised paving system, please refer to the Section: "Raised Laying".
Supports pour le système de carrelage surélevé dans la Section "Pose surélevée".
Stelzlager für Doppelboden Wire im Abschnitt "Verlegung auf Stelzlager".

* A disposizione solo su richiesta. Tempi di consegna 30 gg.
Available upon request only. Delivery terms: 30 days.
Disponibile seulement sur requête. Délais de livraison: 30 jours.
Verfügbar auf Anfrage. Lieferzeit: 30 Tage.

Costa retta.
Straight edge.
Bord droit.
Gerade Kante.

Costa toro.
Bullnose edge.
Bord boudin.
Abgerundete Kante.

AURUM STONE

La tipica pietra calcarea della Baviera, un materiale elegante color paglierino dalle tonalità che spaziano dall'oro al beige, caratterizzata da particolari "disegni" che i sedimenti dell'acqua hanno lasciato sulla superficie nel corso dei millenni, è la fonte ispirativa di **AURUM STONE**. Una collezione in gres porcellanato sviluppata in 1 solo colore per mantenere intatta, con la qualità dell'alta definizione, l'essenza ed il carattere proprio della pietra originale. Arricchita con una completa gamma di formati e con finiture da interno e antiscivolo R11 da esterno ne fanno una collezione completa in grado di arredare in piena continuità cromatica ambienti interni ed esterni, sia residenziali che commerciali.

The source of inspiration for **AURUM STONE** is aurum, a limestone, commonly found in Bavaria. A stylish straw-coloured material, aurum features shades ranging from gold to beige and unusual patterns created by the water sediments that have built up on its surface over millennia. The porcelain stoneware collection is produced in one colour only, to honour the essence and character of the original stone, with high definition quality. Offering a full range of sizes, the interior and non-slip R11 exterior finishes make this collection complete, guaranteeing total colour continuity for indoor and outdoor spaces in residential and commercial settings.

La pierre calcaire typique de Bavière, un élégant matériau jaune ambré dans des tons allant de l'or au beige, caractérisé par des « dessins » particuliers que les sédiments aqueux ont laissés à la surface pendant des milliers d'années, est la source d'inspiration de **AURUM STONE**. Une collection en grès cérame développée dans une seule couleur pour préserver l'essence et le caractère de la pierre originale avec la qualité de la haute définition. Enrichie d'une gamme complète de dimensions et de finitions antidérapantes R11 pour l'intérieur et l'extérieur, cette collection complète est en mesure de meubler des espaces intérieurs et extérieurs, résidentiels et commerciaux, dans une continuité chromatique absolue.

Der typische Kalkstein aus Bayern, ein elegantes strohfarbenedes Material mit von Gold bis Beige reichenden Nuancen, das sich durch besondere "Muster" auszeichnet, die die Sedimente des Wassers im Laufe der Jahrtausende an der Oberfläche zurückgelassen haben, ist die Inspirationsquelle für **AURUM STONE**. Eine Kollektion aus Feinsteinzeug, die in nur einer Farbe entwickelt wurde, um das Wesentliche und den Charakter des Originalsteins mit der Qualität der hohen Auflösung unversehrt zu erhalten. Bereichert durch eine vollständige Palette an Formaten und mit rutschfesten Oberflächen R11 für den Innen- und Außenbereich, machen sie zu einer kompletten Kollektion, mit der sich Innen- und Außen-, Wohn- und Geschäftsbereiche in voller Farbkontinuität einrichten lassen.

100% Made in Italy





PARETE CAMINO . FIREPLACE WALL: PURE Muretto 15x60 Nat. Ret.
PAVIMENTO . FLOOR: PURE 60x120 Nat. Ret.

AURUM STONE

FORMATI

Sizes / Formats / Formate

9 mm . 60x120 - 24"x48" / 60x60 - 24"x24" / 30x60 - 12"x24" / 30,2x60,4 - 12"x24"
20 mm R11 . 60x60 - 24"x24"

COLORI

Colours / Couleurs / Farben



PURE

POSA MODULARE

Modular laying / Pose Modulaire / Modulare Verlegung

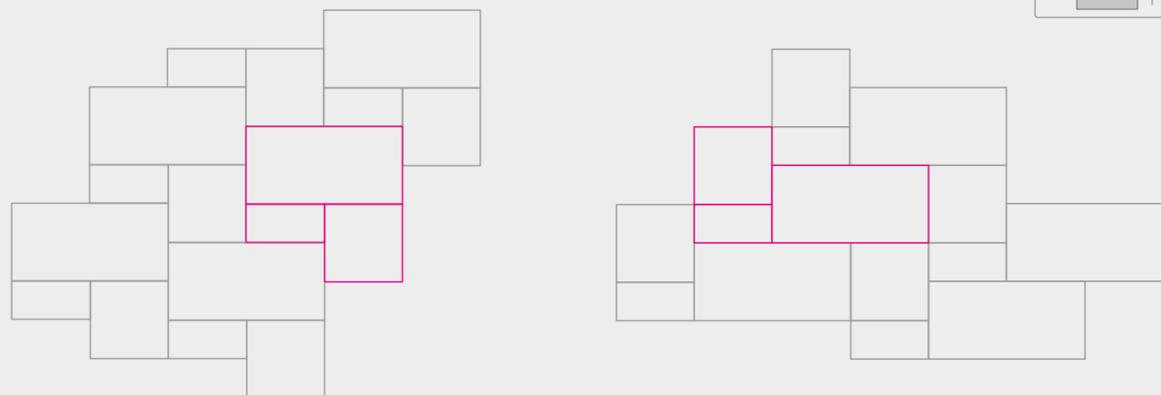
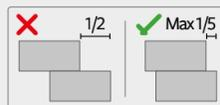

Percentuali posa modulare

Modular laying percentages - Pourcentages de pose modulaire - Anteile bei modularer Verlegung

60x120 - 57%
60x60 - 29%
30x60 - 14%

Fuga consigliata:

Recommended joint size - Joint conseillé - Empfohlene Fuge

minimo 2 mm per la posa in monoformato degli articoli rettificati.

at least 2 mm when laying one tile size only and using straight-edge tiles - 2 mm minimum pour la pose en monoformat des articles rectifiés - mindestens 2 mm bei der Verlegung der geschliffenen Artikel in einem Format

minimo 3 mm per la posa in multiformato (da 2 formati e oltre) degli articoli rettificati.

at least 3 mm when laying different sized straight-edge tiles (two or more sizes) together - 3 mm minimum pour la pose en multiformat (à partir de 2 formats) des articles rectifiés - mindestens 3 mm bei der Verlegung der geschliffenen Artikel als Multiformat (2 Formate und mehr)

minimo 4 mm per la posa degli articoli con bordi non rettificati.

at least 4 mm when laying tiles without a straight edge - 4 mm minimum pour la pose des articles avec des bords non rectifiés - mindestens 4 mm bei der Verlegung der Artikel mit ungeschliffenen Kanten

CONTINUITÀ PROGETTUALE INDOOR-OUTDOOR

Design continuity indoors and out / Continuité conceptuelle à l'intérieur et à l'extérieur / Entwurfskontinuität im innen-und Aussenbereich



INDOOR

SPESORE
INTEGRATA
9mm

Soluzioni contemporanee per l'interior design

Contemporary solutions for interior design.
Solutions contemporaines pour le design intérieur.
Zeitgemäße Lösungen für das Interior Design.



R11
A+B+C

OUTDOOR

SPESORE
INTEGRATA
20mm

Versatilità e prestazioni per la progettazione in esterna

Versatility and performance for outdoor design.
Polyvalence et performance pour l'aménagement extérieur.
Vielseitigkeit und Leistungen für Outdoor-Design.

SISTEMI DI POSA

Laying systems / Systemes de pose / Verlegearten

Posa su erba

Laying on grass
Pose sur l'herbe
Verlegung auf Wiese



Posa su sabbia

Laying on sand
Pose sur sable
Verlegung auf Sand



Posa sopraelevata

Raised laying
Pose surélevée
Verlegung auf Stelzlager

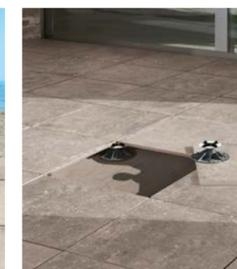

Posa su ghiaia

Laying on gravel
Pose sur gravier
Verlegung auf Kies



Posa tradizionale

Standard laying
Pose traditionnelle
Herkömmliche Verlegung



AURUM STONE

Spessore . Thickness . Epaisseur . Stärke - 9 mm - 20 mm R11

Gres porcellanato colorato in massa. Full-body coloured porcelain stoneware. Grès cérame coloré dans la masse. In der Masse gefärbtes Feinsteinzeug.

INDOOR - OUTDOOR

TABELLA RIEPILOGATIVA
Summary table
Tableau récapitulatif
Zusammenfassende Tabelle

														
		60x120 24"x48"	60x60 24"x24"	60x60 24"x24"	30x60 12"x24"	30,2x60,4 12"x24"	Mosaico (5x5) 30x30 12"x12"	Muretto 15x60 6"x24"	*** Copriscipigolo triangolare 1,4x120 1/2"x48"	Ang. Copriscipigolo triang. 1,4x1,4 1/2"x 1/2"	Battiscopa 7,2x60 3"x24"	* Gradino a C 33x120x3,2h 13"x48"x1 1/4"h	* Ang. Gradino a C - SX 33x120x3,2h 13"x48"x1 1/4"h	* Ang. Gradino a C - DX 33x120x3,2h 13"x48"x1 1/4"h
SPESSORE - THICKNESS - EPAISSEUR - STÄRKE		▼ 9 mm	▼ 9 mm	20 mm R11	▼ 9 mm	▼ 9 mm	▼ 9 mm	▼ 9 mm	▼ 9 mm	▼ 9 mm	▼ 9 mm	▼ 9 mm	▼ 9 mm	▼ 9 mm
	□ Nat. Ret.	102001	102010	102013	102018		102038	102040	102070	102071	102061	102075	102076	102077
	■ Nat. Nat.					102015								
IMBALLI - PACKAGING EMBALLAGE - VERPACKUNG														
		Pallet	Pallet	Pallet	Pallet	Pallet	Pallet							
		80x120	80x120	80x120	80x120	80x120	80x120							
N°														
m ²														
Kg														
 x 		2	4	2	6	6	11	3	6		14	2	1	1
 m ² x 		1,44	1,44	0,72	1,08	1,1	0,99	0,27						
 Kg x 		29	29,5	32	22	22,5	19,5	5,4	1,8		10,6	21	10,5	10,5
 x 		30	30	32	40	40								
 m ² x 		43,2	43,2	23,04	43,2	44								
** Kg x 		890	905	1044	900	920								
 x 		75	75	75	75	76								
Imballo (tara) - Packaging (tare)		(20)	(20)	(20)	(20)	(20)	(20)	(20)	(20)		(20)	(20)	(20)	(20)

▼ Gli articoli nel nuovo spessore 9 mm saranno disponibili ad esaurimento dello stock esistente in spessore 10 mm.
9 mm items will be available once the current 10 mm stock we have has run out.
Les articles de 9 mm d'épaisseur seront disponibles dès que le stock en 10 mm sera terminé.
Die 9 mm Artikel werden verfügbar sein, sobald die 10 mm Lagerbestände abverkauft sind.

* A disposizione solo su richiesta. Tempi di consegna 30 gg.
Available upon request only. Delivery terms: 30 days.
Disponibile seulement sur requête. Délais de livraison: 30 jours.
Verfügbar auf Anfrage. Lieferzeit: 30 Tage.

** Il peso è comprensivo dell'imballo.
The total weight includes the packaging.
Le poids comprend aussi l'emballage.
Das Gesamtgewicht enthält auch die Verpackung.

*** Vendita a scatola completa.
Full box sale.
Vente à la boîte complète.
Volle Kartons.

I pesi riportati in tabella sono indicativi e potrebbero essere soggetti a leggere variazioni.
The weights stated in the chart may undergo slight changes for production reasons.
Les poids indiqués dans le tableau peuvent subir de légères variations pour des raisons de production.
Die in der Tabelle angegebenen Gewichte können aus Produktionsgründen geringfügigen Abweichungen unterliegen.

Non si garantisce l'abbinabilità tra fondi di spessori diversi e tra fondo e pezzo speciale.
It is not guaranteed that background tiles with different thicknesses can be used together, nor is it guaranteed for background tiles and trims.
Nous ne garantissons pas la possibilité de combiner des carrelages de sol de différentes épaisseurs et un carrelage de sol avec une pièce spéciale.
Die Kombinierbarkeit von Fliesen unterschiedlicher Stärke sowie zwischen Fliese und Formteil kann nicht garantiert werden.

□ Naturale e rettificato.
Natural rectified.
Naturel et rectifié.
Natur Oberfläche und rektifiziert.

■ Naturale e naturale.
Natural and natural.
Naturel et naturel.
Natur natur.

PEZZI SPECIALI PER ESTERNO 20 mm R11 - □ Nat. Ret.
Special pieces for outdoor - Pièces spéciales pour extérieur - Formteile für Aussenbereich

 * Gradone 30x60 . 12"x24"	 * Ang. Gradone - SX 30x60 . 12"x24"	 * Ang. Gradone - DX 30x60 . 12"x24"
 * Gradone grip 30x60 . 12"x24"	 * Ang. Gradone grip - SX 30x60 . 12"x24"	 * Ang. Gradone grip - DX 30x60 . 12"x24"
 * Elemento a L 33x60x4h . 13"x24"x1 1/2"h	 * Elemento a L SX 33x60x4h . 13"x24"x1 1/2"h	 * Elemento a L DX 33x60x4h . 13"x24"x1 1/2"h

PEZZI SPECIALI PER PISCINA 20 mm R11 - □ Nat. Ret.
Special pieces for swimming pool - Pièces spéciales pour piscine - Formteile für Schwimmbad

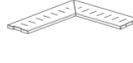
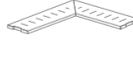
 * Gradone bordo piscina 30x60 . 12"x24"	 * Ang. Gradone bordo piscina - SX 30x60 . 12"x24"	 * Ang. Gradone bordo piscina - DX 30x60 . 12"x24"
 * Gradone grip bordo piscina 30x60 . 12"x24"	 * Ang. Gradone grip bordo piscina - SX 30x60 . 12"x24"	 * Ang. Gradone grip bordo piscina - DX 30x60 . 12"x24"
 * Gradone svasato bordo piscina 30x60 . 12"x24"	 * Ang. Gradone svasato bordo piscina - SX 30x60 . 12"x24"	 * Ang. Gradone svasato bordo piscina - DX 30x60 . 12"x24"
 * Griglia 20x60 . 8"x24"	 * Griglia SX 20x60 . 8"x24"	 * Griglia DX 20x60 . 8"x24"

Per maggiori informazioni su imballi e codici articolo consultare la Sezione Tecnica: "Pezzi speciali per esterno" e "Pezzi speciali per piscina".
For more information on packaging and item codes, please refer to the Technical Section: "Special pieces for outdoor" and "Special pieces for swimming pools".
Pour plus d'informations sur les emballages et les codes articles, vous pouvez consulter la Section Technique: "Pièces spéciales pour extérieur" et "Pièces spéciales pour piscines".
Weitere Informationen für Verpackungen und Artikelcodes finden Sie im Technischen Abschnitt: "Formteile für Außenbereich" und "Formteile für Schwimmbad".

□ Naturale e rettificato.
Natural rectified.
Naturel et rectifié.
Natur Oberfläche und rektifiziert.

 Supporti per pavimentazioni sopraelevate nella Sezione "Posa sopraelevata".
Supports for raised paving system, please refer to the Section: "Raised Laying".
Supports pour le système de carrelage surélevé dans la Section "Pose surélevée".
Stelzlager für Doppelboden Wire im Abschnitt "Verlegung auf Stelzlager".

* A disposizione solo su richiesta. Tempi di consegna 30 gg.
Available upon request only. Delivery terms: 30 days.
Disponibile seulement sur requête. Délais de livraison: 30 jours.
Verfügbar auf Anfrage. Lieferzeit: 30 Tage.

┃ Costa retta.
Straight edge.
Bord droit.
Gerade Kante.

┃ Costa toro.
Bullnose edge.
Bord boudin.
Abgerundete Kante.

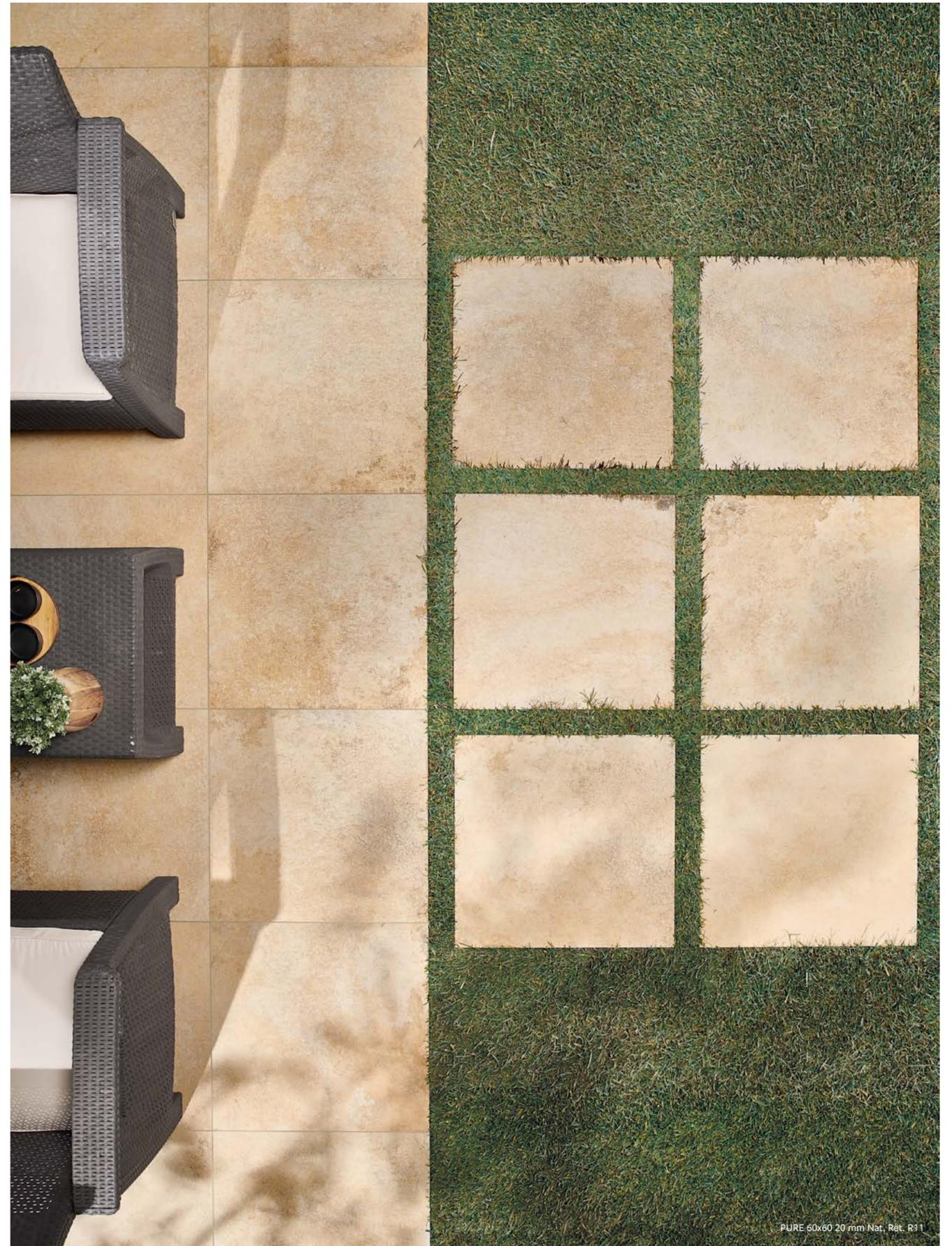

PURE 60x60 20 mm Nat. Ret. R11

CONCRETE & DESIGN



Tavola sinottica delle collezioni

Product recap by look, colour and thickness.
Tableau synoptique des collections.
Übersichtstafel.

COLORI FREDDI 174
COOL COLOURS.
COULEURS FROIDES.
KALTE FARBEN.

COLORI CALDI 175
WARM COLOURS.
COULEURS CHAUDES.
WARME FARBEN.

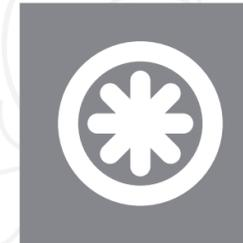
PIETRA DI LUNA 176

METAL 192

CONCRETA 208

APOGEO 224

FULL COLOURS 240

TAVOLA SINOTTICA DELLE COLLEZIONI

Product recap by look, colour and thickness . Tableau synoptique des collections . Übersichtstafel.

COLORI FREDDI

Cool colours . Couleurs froides . Kalte Farben.

□ Naturale e rettificato.
Natural rectified.
Naturel et rectifié.
Natur Oberfläche und rektifiziert.

■ Naturale e naturale.
Natural and natural.
Naturel et naturel.
Natur natur.

○ Lucidato e rettificato.
Glossy rectified.
Brillant et rectifié.
Glossy/Shiny und rektifiziert.

● Naturale non rettificato.
Natural non-rectified.
Naturel non rectifié.
Natur nicht rektifiziert.

○ Lucidato non rettificato.
Glossy non-rectified.
Brillant non rectifié.
Glossy/Shiny nicht rektifiziert.

◇ Velvet rettificato.
Velvet rectified.
Velvet rectifié.
Velvet rektifiziert.

COLORI CALDI

Warm colours . Couleurs chaudes . Warme Farben.

		MIDNIGHT	NOIR	TITANIUM	BLACK	GRIS	SHADOW	GRIGIO SCURO	GRIGIO CHIARO	GREY	IRON	MOON	BLANC	PEARL	BEIGE	WHITE	DESERT	ARGENT	CLOUD	TERRA	ANTHRACITE	CORTEN	OXIDE	BLEU			
		FULL COLOURS PAG. 240	PIETRA DI LUNA PAG. 176	METAL PAG. 192	APOGEO PAG. 224	PIETRA DI LUNA PAG. 176	FULL COLOURS PAG. 240	CONCRETA PAG. 208	CONCRETA PAG. 208	APOGEO PAG. 224	METAL PAG. 192	FULL COLOURS PAG. 240	PIETRA DI LUNA PAG. 176	METAL PAG. 192	PIETRA DI LUNA PAG. 176	APOGEO PAG. 224	FULL COLOURS PAG. 240	PIETRA DI LUNA PAG. 176	FULL COLOURS PAG. 240	CONCRETA PAG. 208	APOGEO PAG. 224	METAL PAG. 192	METAL PAG. 192	PIETRA DI LUNA PAG. 176			
R I N D O O R	6 mm	160x320 63"x126"	□ Nat. Ret. ○ Luc. Ret.				□ Nat. Ret. ○ Luc. Ret.					□ Nat. Ret. ○ Luc. Ret.					□ Nat. Ret. ○ Luc. Ret.		□ Nat. Ret. ○ Luc. Ret.								
		120x280 48"x110"	□ Nat. Ret. ○ Luc. Ret.		□ Nat. Ret.	□ Nat. Ret.		□ Nat. Ret. ○ Luc. Ret.	□ Nat. Ret.	□ Nat. Ret.	□ Nat. Ret.	□ Nat. Ret.	□ Nat. Ret. ○ Luc. Ret.		□ Nat. Ret.		□ Nat. Ret.	□ Nat. Ret. ○ Luc. Ret.		□ Nat. Ret. ○ Luc. Ret.	□ Nat. Ret.	□ Nat. Ret.	□ Nat. Ret.	□ Nat. Ret.	□ Nat. Ret.	□ Nat. Ret.	□ Nat. Ret.
		120x120 48"x48"	□ Nat. Ret. ○ Luc. Ret.		□ Nat. Ret.	□ Nat. Ret.		□ Nat. Ret. ○ Luc. Ret.			□ Nat. Ret.	□ Nat. Ret.	□ Nat. Ret. ○ Luc. Ret.		□ Nat. Ret.		□ Nat. Ret.	□ Nat. Ret. ○ Luc. Ret.		□ Nat. Ret. ○ Luc. Ret.			□ Nat. Ret.	□ Nat. Ret.	□ Nat. Ret.	□ Nat. Ret.	□ Nat. Ret.
		80x80 31"x31"½	□ Nat. Ret. ○ Luc. Ret.										□ Nat. Ret. ○ Luc. Ret.														
	9 mm	120x120 48"x48"						□ Nat. Ret.	□ Nat. Ret.												□ Nat. Ret.						
		60x120 24"x48"	□ Nat. Ret. ○ Luc. Ret.		□ Nat. Ret.	□ Nat. Ret.		□ Nat. Ret.	□ Nat. Ret.	□ Nat. Ret.	□ Nat. Ret.	□ Nat. Ret.	□ Nat. Ret. ○ Luc. Ret.		□ Nat. Ret.		□ Nat. Ret.	□ Nat. Ret.		□ Nat. Ret.	□ Nat. Ret.	□ Nat. Ret.	□ Nat. Ret.	□ Nat. Ret.	□ Nat. Ret.	□ Nat. Ret.	□ Nat. Ret.
		60x60 24"x24"				□ Nat. Ret.		□ Nat. Ret.	□ Nat. Ret.	□ Nat. Ret.	□ Nat. Ret.					□ Nat. Ret.					□ Nat. Ret.	□ Nat. Ret.					
	10 mm	90x90 36"x36"		◇ Velvet Ret. □ Nat. Ret.		□ Nat. Ret.	◇ Velvet Ret. □ Nat. Ret.		□ Nat. Ret.	□ Nat. Ret.	□ Nat. Ret.			◇ Velvet Ret. □ Nat. Ret.		◇ Velvet Ret. □ Nat. Ret.	□ Nat. Ret.		◇ Velvet Ret. □ Nat. Ret.		□ Nat. Ret.	□ Nat. Ret.				◇ Velvet Ret. □ Nat. Ret.	
		45x90 18"x36"		◇ Velvet Ret. □ Nat. Ret.		□ Nat. Ret.	◇ Velvet Ret. □ Nat. Ret.		□ Nat. Ret.	□ Nat. Ret.	□ Nat. Ret.			◇ Velvet Ret. □ Nat. Ret.		◇ Velvet Ret. □ Nat. Ret.	□ Nat. Ret.		◇ Velvet Ret. □ Nat. Ret.		□ Nat. Ret.	□ Nat. Ret.				◇ Velvet Ret. □ Nat. Ret.	
	12 mm	163x324 64"x127"	● Nat. non ret. ○ Luc. non ret.					● Nat. non ret. ○ Luc. non ret.					● Nat. non ret. ○ Luc. non ret.						● Nat. non ret. ○ Luc. non ret.		● Nat. non ret. ○ Luc. non ret.						
		20 mm	163x324 64"x127"	● Nat. non ret. ○ Luc. non ret.				● Nat. non ret. ○ Luc. non ret.					● Nat. non ret. ○ Luc. non ret.						● Nat. non ret. ○ Luc. non ret.		● Nat. non ret. ○ Luc. non ret.						
	O O D O O R	9 mm	30,2x60,4 12"x24"					■ Nat. Nat. R11	■ Nat. Nat. R11													■ Nat. Nat. R11					
10 mm			45x90 18"x36"		□ Nat. Ret. R11		□ Nat. Ret. R11	□ Nat. Ret. R11	□ Nat. Ret. R11	□ Nat. Ret. R11				□ Nat. Ret. R11							□ Nat. Ret. R11	□ Nat. Ret. R11					
20 mm		120x120 48"x48"					□ Nat. Ret. R11	□ Nat. Ret. R11													□ Nat. Ret. R11						
		90x90 36"x36"				□ Nat. Ret. R11		□ Nat. Ret. R11	□ Nat. Ret. R11	□ Nat. Ret. R11				□ Nat. Ret. R11							□ Nat. Ret. R11	□ Nat. Ret. R11					
		60x120 24"x48"			□ Nat. Ret. R11	□ Nat. Ret. R11				□ Nat. Ret. R11	□ Nat. Ret. R11				□ Nat. Ret. R11						□ Nat. Ret. R11	□ Nat. Ret. R11	□ Nat. Ret. R11	□ Nat. Ret. R11	□ Nat. Ret. R11	□ Nat. Ret. R11	
30 mm		60x60 24"x24"			□ Nat. Ret. R11		□ Nat. Ret. R11	□ Nat. Ret. R11	□ Nat. Ret. R11	□ Nat. Ret. R11				□ Nat. Ret. R11							□ Nat. Ret. R11	□ Nat. Ret. R11					
	90x90 36"x36"				□ Nat. Ret. R11		□ Nat. Ret. R11	□ Nat. Ret. R11	□ Nat. Ret. R11				□ Nat. Ret. R11							□ Nat. Ret. R11	□ Nat. Ret. R11						
		60x60 24"x24"			□ Nat. Ret. R11		□ Nat. Ret. R11	□ Nat. Ret. R11	□ Nat. Ret. R11				□ Nat. Ret. R11							□ Nat. Ret. R11	□ Nat. Ret. R11						

PIETRA DI LUNA

Blu, bianco, gradazioni di grigio e beige, un nero profondo con brillanti microglitter, **PIETRA DI LUNA** è fluida, emotiva, misteriosa. Una collezione versatile che si propone come il mezzo per dare forma alla personalità di chi la sceglie per vestire gli ambienti con atmosfere moderne ed high tech oppure romantiche e retrò. Una struttura superficiale sapientemente lavorata per un effetto pietra, vellutata al tatto nella finitura "velvet", la rendono una collezione unica, fuori dalle convenzioni, fuori dal tempo.

Blue, white, in shades of grey and beige, a deep black with shiny micro glitter, **PIETRA DI LUNA** is fluid, thrilling, mysterious. A versatile collection that aims to be the means to give shape to the personality of those who choose it, dressing environments with a modern and high-tech atmosphere or a romantic and retro one. A surface structure skilfully worked to obtain a stone effect, velvety to the touch in the "velvet" finish, make it a unique, unconventional, timeless collection.

Bleu, blanc, dans les nuances de gris et de beige, un noir profond avec des paillettes microglitter, **PIETRA DI LUNA** est fluide, émotif, mystérieux. Une collection flexible proposée comme un moyen pour donner forme à la personnalité de ceux qui la choisissent pour habiller les espaces avec des atmosphères modernes et high-tech ou bien romantiques et rétro. Sa structure superficielle savamment travaillée pour un effet pierre, veloutée au toucher dans la finition "velvet", fait d'elle une collection unique, non conventionnelle, hors du temps.

Blau, weiß, in grau- und beigeabstufungen, ein tiefes schwarz mit leuchtendem mikroglitter - **PIETRA DI LUNA** ist fließend, emotional und geheimnisvoll. Eine vielseitige kollektion als mittel, der persönlichkeit des bewohners gestalt zu verleihen, wenn er die räume mit modernen und hochtechnologischen oder romantischen und retro-atmosphären schmückt. Eine gekonnt bearbeitete oberflächenstruktur mit steineffekt, die sich in der ausführung „velvet“ samtig anfühlt, macht sie zu einer einzigartigen kollektion, unkonventionell und zeitlos.

100% Made in Italy



RIVESTIMENTO . WALL: LEAVES 90x90 Nat. Ret. - BLANC 90x90 / 45x90 Velvet Ret.
PAVIMENTO . FLOOR: BLANC 90x90 Velvet Ret.

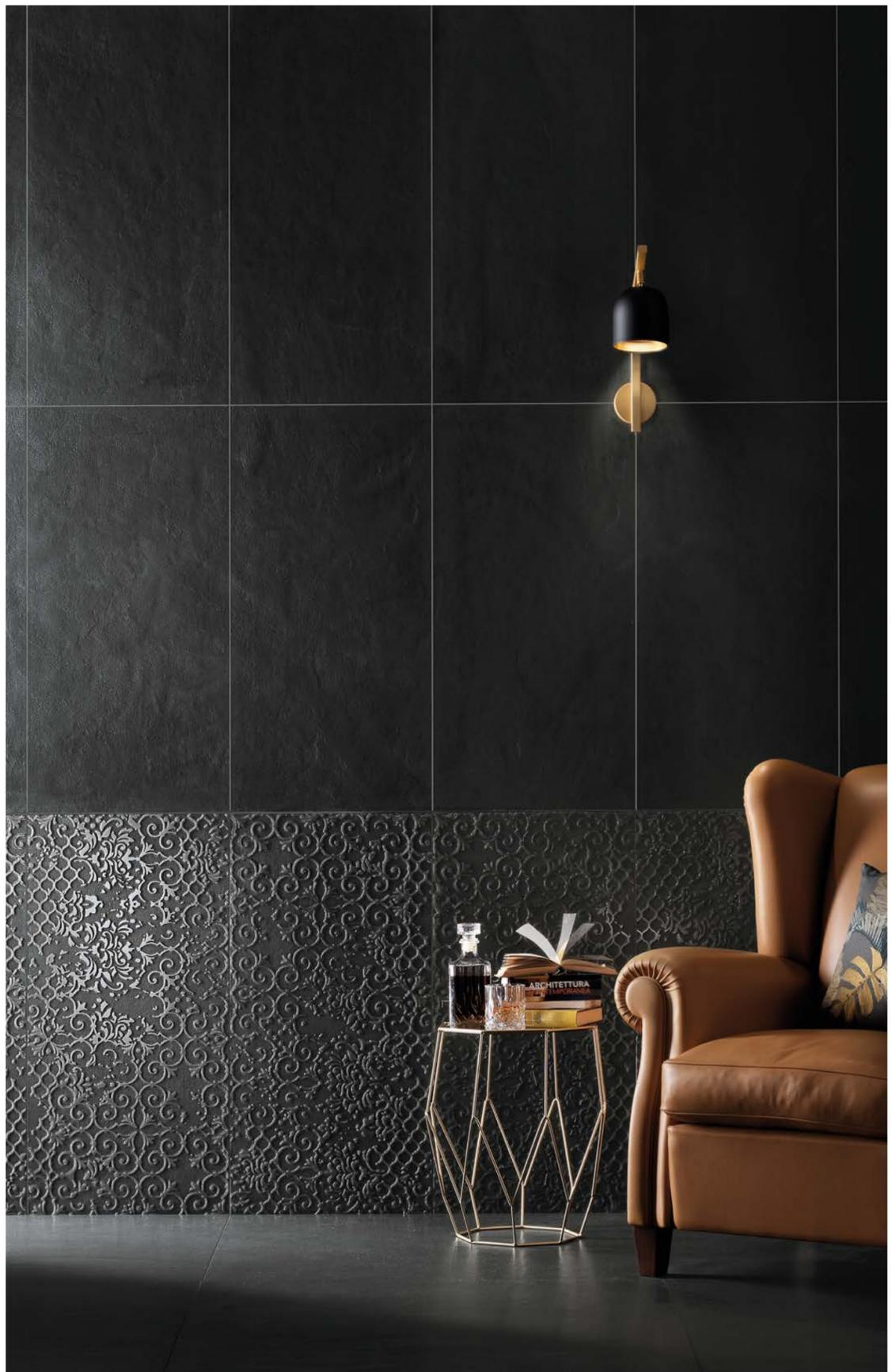

RIVESTIMENTO . WALL: VICHY NOIR 45x90 Lucidato Ret. - NOIR 45x90 Nat. Ret.
PAVIMENTO . FLOOR: NOIR 90x90 Nat. Ret.



RIVESTIMENTO . WALL: NOIR 45x90 Nat. Ret.
PAVIMENTO . FLOOR: ARGENT 90x90 Nat. Ret.



Mosaico CUBICS A 30x39 Nat. Ret.
ARGENT 45x90 Nat. Ret.



BEIGE 90x90 Nat. Ret.



GRIS 90x90 Nat. Ret.

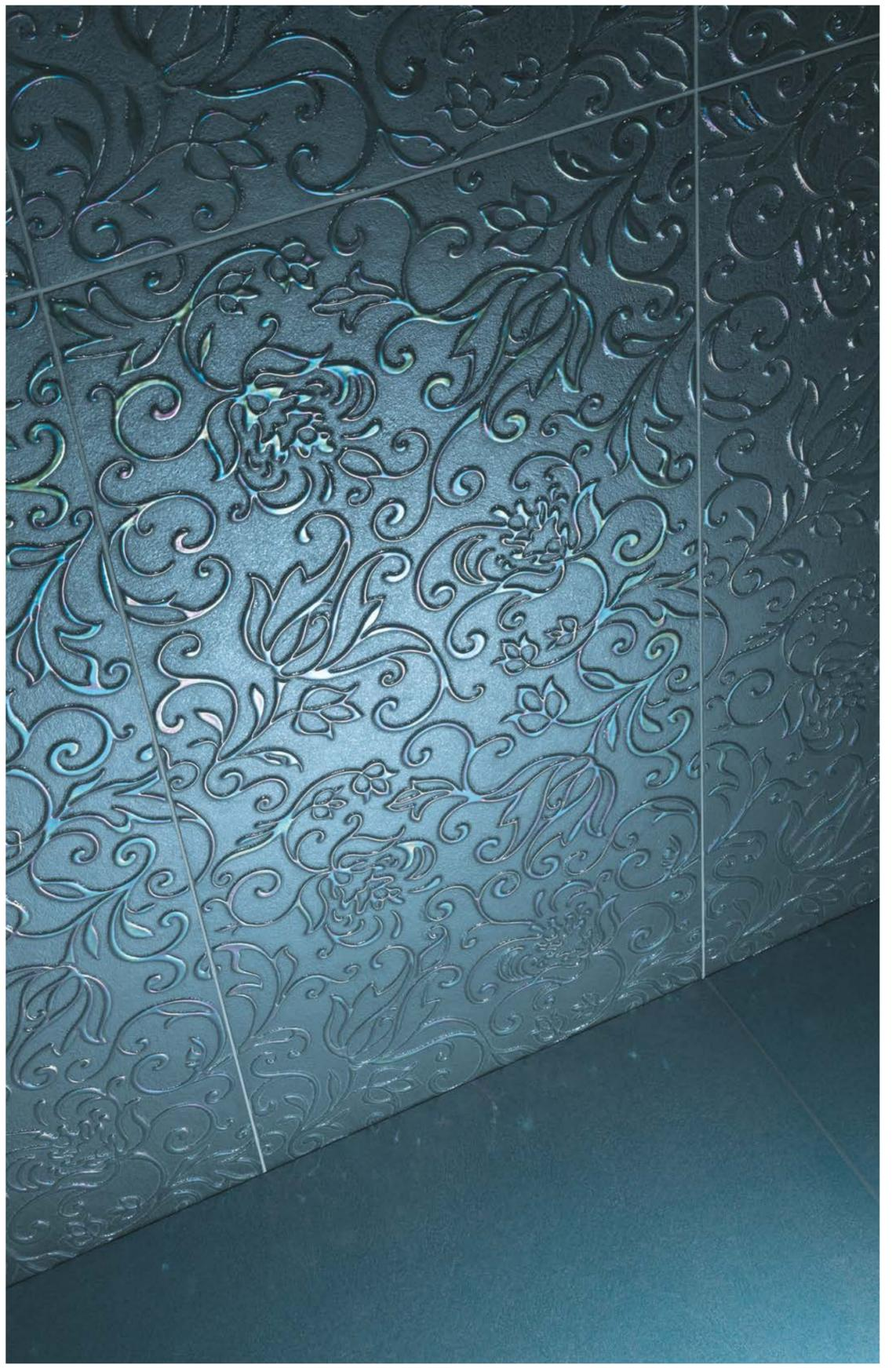

RIVESTIMENTO . WALL: IRIS BLEU 45x90 Lucidato Ret. - BLEU 45x90 Nat. Ret.
PAVIMENTO . FLOOR: BLEU 90x90 Nat. Ret.

PIETRA DI LUNA

FORMATI

Sizes / Formats / Formate

10 mm . 90x90 - 35½"x35 ½" / 45x90 - 18"x35 ½"

COLORI

Colours / Couleurs / Farben

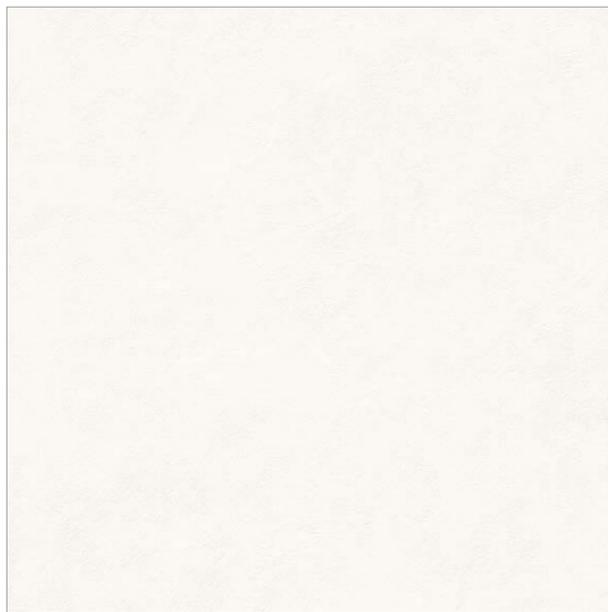

BLANC

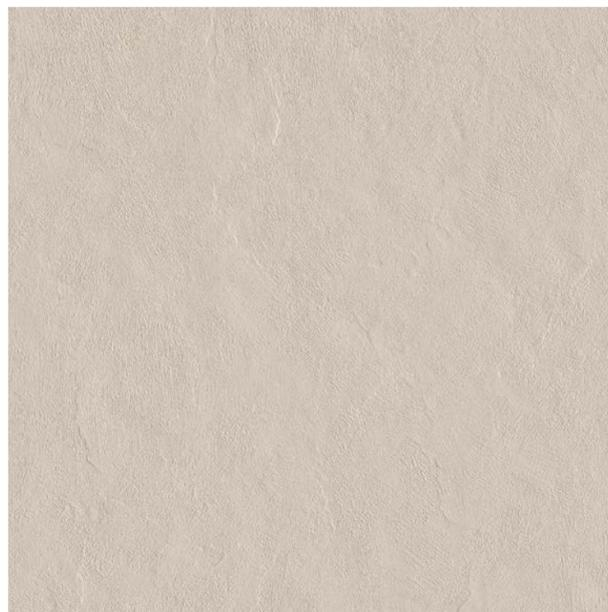

ARGENT



GRIS

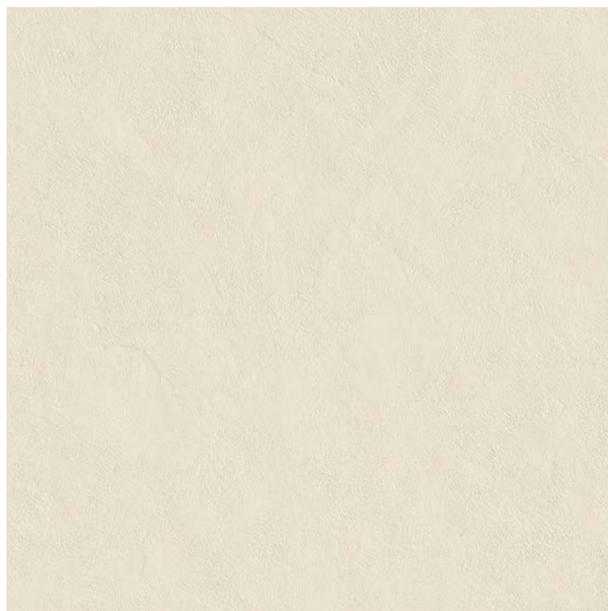

BEIGE



BLEU



NOIR

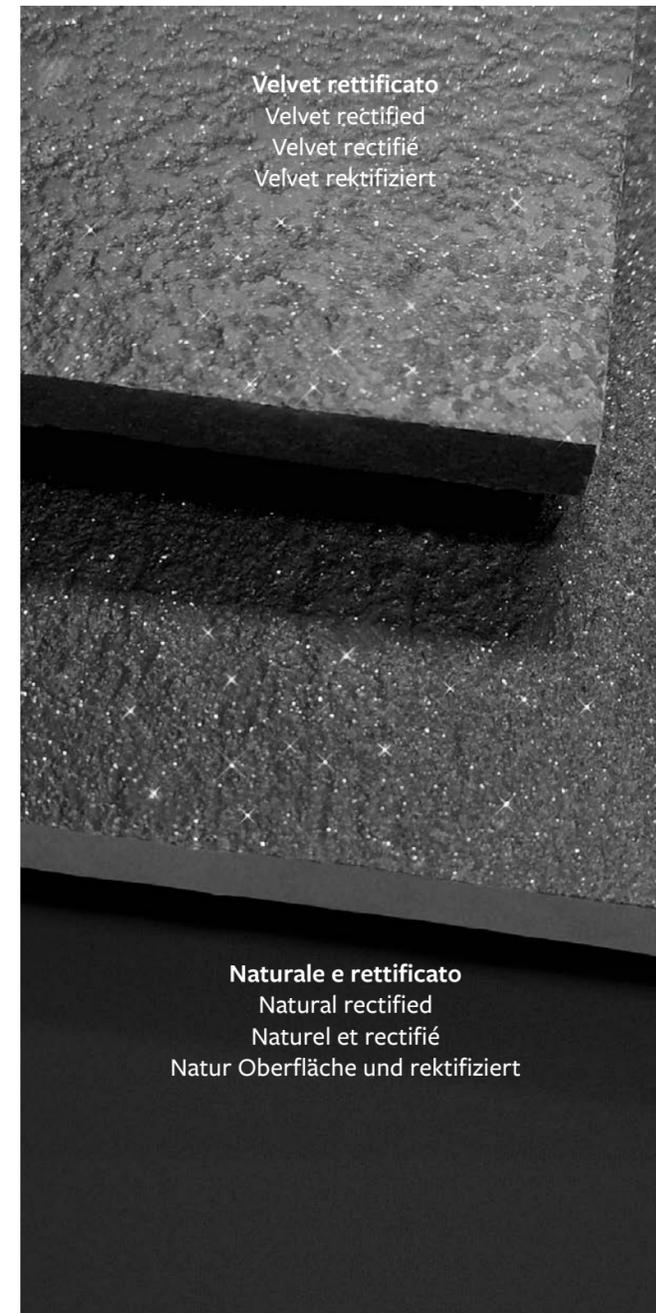

PIETRA DI LUNA

Spessore . Thickness . Epaisseur . Stärke - 10 mm

Gres porcellanato colorato in massa. Full-body coloured porcelain stoneware. Grès cérame coloré dans la masse. In der Masse gefärbtes Feinsteinzeug.

TABELLA RIEPILOGATIVA

Summary table
Tableau récapitulatif
Zusammenfassende Tabelle

													
		90x90 35 1/2"x35 1/2"	45x90 18"x35 1/2"	Mosaico (5x5) 30x30 12"x12"	Muretto 15x60 6"x24"	A Mosaico Cubics 30x39 12"x15 1/2"	B	** * Copriscopigolo triangolare 1,4x90 1/2"x35 1/2"	Angolo Copriscopigolo triangolare 1,4x1,4 1/2"x1/2"	Battiscopa 7,2x90 3"x35 1/2"	* Gradino a C 33x90x3,2h 13"x35 1/2"x1 1/4"h	* Ang. Gradino a C - DX 33x90x3,2h 13"x35 1/2"x1 1/4"h	* Ang. Gradino a C - SX 33x90x3,2h 13"x35 1/2"x1 1/4"h
Spessore - Thickness - Epaisseur - Stärke		10 mm	10 mm	10 mm	10 mm	10 mm	10 mm	10 mm	10 mm	10 mm	10 mm	10 mm	10 mm
	NOIR	◇ Velvet Ret.	122009	122073	122210	122230		122510	122531	122160	122310	122330	122351
		□ Nat. Ret.	122019	122083	122211	122231	122242	122511	122532	122161	122311	122331	122352
	BLANC	◇ Velvet Ret.	122001	122069	122200	122220		122500	122521	122150	122300	122320	122341
		□ Nat. Ret.	122015	122079	122201	122221	122241	122501	122522	122151	122301	122321	122342
	BEIGE	◇ Velvet Ret.	122003	122070	122206	122226		122506	122527	122156	122306	122326	122347
		□ Nat. Ret.	122016	122080	122207	122227	122241	122507	122528	122157	122307	122327	122348
	ARGENT	◇ Velvet Ret.	122007	122072	122202	122222		122502	122523	122152	122302	122322	122343
		□ Nat. Ret.	122018	122082	122203	122223	122241	122503	122524	122153	122303	122323	122344
	GRIS	◇ Velvet Ret.	122005	122071	122204	122224		122504	122525	122154	122304	122324	122345
		□ Nat. Ret.	122017	122081	122205	122225	122242	122505	122526	122155	122305	122325	122346
	BLEU	◇ Velvet Ret.	122021	122085	122208	122228		122508	122529	122158	122308	122328	122349
		□ Nat. Ret.	122020	122084	122209	122229	122242	122509	122530	122159	122309	122329	122350
IMBALLI - PACKAGING EMBALLAGE - VERPACKUNG													
		Pallet	Pallet	Pallet	Pallet	Pallet	Pallet			Pallet	Pallet	Pallet	Pallet
		94x120	94x120	80x120	80x120	80x120	80x120			80x120	80x120	80x120	80x120
N°													
m²													
** Kg													
 x		2	3	11	3	6	6	6		8	2	1	1
m² x		1,62	1,22	0,99	0,27	0,66	0,66						
Kg x		37	27	20,5	6	14,6	14,6	2		11	16,5	8,5	8,5
 x		20	32										
m² x		32,4	39,04										
** Kg x		760	884										
h x		64	60										
Imballo (tara) - Packaging (tare)		(20)	(20)	(20)	(20)	(20)	(20)			(20)	(20)	(20)	(20)

I pesi riportati in tabella sono indicativi e potrebbero essere soggetti a leggere variazioni.
The weights stated in the chart may undergo slight changes for production reasons.
Les poids indiqués dans le tableau peuvent subir de légères variations pour des raisons de production.
Die in der Tabelle angegebenen Gewichte können aus Produktionsgründen geringfügigen Abweichungen unterliegen.

Non si garantisce l'abbinabilità tra fondi di spessori diversi e tra fondo e pezzo speciale.
It is not guaranteed that background tiles with different thicknesses can be used together, nor is it guaranteed for background tiles and trims.
Nous ne garantissons pas la possibilité de combiner des carrelages de sol de différentes épaisseurs et un carrelage de sol avec une pièce spéciale.
Die Kombinierbarkeit von Fliesen unterschiedlicher Stärke sowie zwischen Fliese und Formteil kann nicht garantiert werden.

* A disposizione solo su richiesta. Tempi di consegna 30 gg.
Available upon request only. Delivery terms: 30 days.
Disponible seulement sur requête. Délais de livraison: 30 jours.
Verfügbar auf Anfrage. Lieferzeit: 30 Tage.

** Il peso è comprensivo dell'imballo.
The total weight includes the packaging.
Le poids comprend aussi l'emballage.
Das Gesamtgewicht enthält auch die Verpackung.

*** Vendita a scatola completa.
Full box sale.
Vente à la boîte complète.
Volle Kartons.

□ Naturale e rettificato.
Natural rectified.
Naturel et rectifié.
Natur Oberfläche und rektifiziert.

◇ Velvet rettificato.
Velvet rectified.
Velvet rectifié.
Velvet rektifiziert.

PIETRA DI LUNA

Spessore . Thickness . Epaisseur . Stärke - **10 mm**

Gres porcellanato colorato in massa. Full-body coloured porcelain stoneware. Grès cérame coloré dans la masse. In der Masse gefärbtes Feinsteinzeug.

MANDALA

45x90 - 18"x35 1/2"

VICHY

45x90 - 18"x35 1/2"

IRIS

45x90 - 18"x35 1/2"

NOIR



NOIR



GRIS



ARGENT



NOIR



GRIS



ARGENT



BLANC



BLANC



BEIGE



BLEU



BLANC



BEIGE



BLEU



LEAVES

90x90 - 35 1/2"x35 1/2"



MOSAICO (5x5)

30x30 - 12"x12"

NOIR

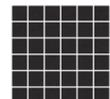

GRIS

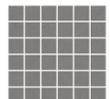

ARGENT



BLANC

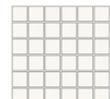

BEIGE



BLEU

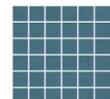

MOSAICO CUBICS

30x39 - 12"x15 1/2"

A

BLANC
BEIGE
ARGENT

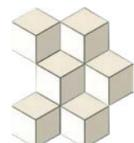

B

NOIR
GRIS
BLEU



MURETTO

15x60 - 6"x24"

NOIR



GRIS



ARGENT



BLANC



BEIGE

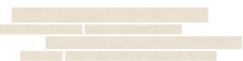

BLEU



LEAVES
90x90
35 1/2"x35 1/2"



MANDALA
45x90
18"x35 1/2"



VICHY
45x90
18"x35 1/2"



IRIS
45x90
18"x35 1/2"

Spessore - Thickness - Epaisseur - Stärke		10 mm	10 mm	10 mm	10 mm
NOIR	○ Lucidato Ret.	-	122407	122426	122416
	□ Nat. Ret.	122401	-	-	-
BLANC	○ Lucidato Ret.	-	122402	122421	122411
	□ Nat. Ret.	122401	-	-	-
BEIGE	○ Lucidato Ret.	-	-	122424	122414
	□ Nat. Ret.	122401	-	-	-
ARGENT	○ Lucidato Ret.	-	-	122422	122412
	□ Nat. Ret.	122401	-	-	-
GRIS	○ Lucidato Ret.	-	-	122423	122413
	□ Nat. Ret.	122401	-	-	-
BLEU	○ Lucidato Ret.	-	-	122425	122415
	□ Nat. Ret.	122401	-	-	-
IMBALLI - PACKAGING EMBALLAGE - VERPACKUNG					
		Pallet	Pallet	Pallet	Pallet
N°					
m²					
** Kg					
		1	2	2	2
m² x		0,81	0,81	0,81	0,81
Kg x		18	18	18	18
m² x					
** Kg x					
h x					
Imballo (tara) - Packaging (tare)					

□ Naturale e rettificato.
Natural rectified.
Naturel et rectifié.
Natur Oberfläche und rektifiziert.

○ Lucidato e rettificato.
Glossy rectified.
Brillant et rectifié.
Glossy/Shiny und rektifiziert.

✎ Da rivestimento.
Wall tile.
Décor pour revêtement.
Für Wandbelag.

METAL

Una collezione segnata dal tempo dove corrosione ed ossidazione entrano in scena donando alle lastre metalliche una personalità sempre varia ed originale. **METAL** si declina nei colori Pearl, Iron, Corten, Oxide, Titanium, in tre spessori, nei formati 120x280, 120x120, 60x120 cm. Grazie anche alla finitura R11 per outdoor **METAL** crea continuità cromatica con ambienti indoor.

A collection marked by time where corrosion and oxidation take the stage, giving the metal sheets an always varied and original personality. **METAL** is available in the colours Pearl, Iron, Corten, Oxide, Titanium, in three thicknesses and in the sizes 120x280, 120x120, 60x120 cm. Thanks also to the outdoor R11 finish, **METAL** creates chromatic continuity with indoor environments.

Une collection marquée par le temps, où la corrosion et l'oxydation occupent une place centrale, conférant aux dalles métalliques une personnalité originale et changeante. **METAL** se décline dans les couleurs Pearl, Iron, Corten, Oxide et Titanium, en trois épaisseurs et dans les dimensions 120x280, 120x120 et 60x120 cm. Grâce également à la finition R11 pour l'extérieur, **METAL** crée une continuité chromatique avec les environnements intérieurs.

Eine von der Zeit geprägte Kollektion, in der Korrosion und Oxidation zum tragenden Element werden und den Metallplatten eine vielfältige und originelle Persönlichkeit verleihen. **METAL** ist in den Farben Pearl, Iron, Corten, Oxide, Titanium, in drei Stärken und in den Formaten 120x280, 120x120, 60x120 cm erhältlich. Auch dank der R11-Oberfläche für den Außenbereich schafft **METAL** eine farbliche Kontinuität mit Innenräumen.

100% Made in Italy

SCALA - STAIRS:
TITANIUM 120x120 Nat. Ret.
Copriscopigolo triangolare TITANIUM 0,8x120 Nat. Ret.

PAVIMENTO - FLOOR:
TITANIUM 120x120 Nat. Ret.



MUSEUM





RIVESTIMENTO . WALL: PEARL 120x280 Nat. Ret.
PAVIMENTO . FLOOR: CORTEN 60x120 Nat. Ret.



IRON 120x120 Nat. Ret.



IRON 60x120 20 mm Nat. Ret. R11

Special pieces for swimming pool:

IRON GRIGLIA + ANG. 20x60 20 mm Nat. Ret. R11

IRON GRADONE GRIP BORDO PISCINA + ANG. 30x120 20 mm Nat. Ret. R11

FORMATI
Sizes / Formats / Formate

6,5 mm . 120x280 - 48"x110" / 120x120 - 48"x48"
9 mm . 60x120 - 24"x48"
20 mm R11. 60x120 - 24"x48"

GRANDI VARIETÀ DI GRAFICHE

Wide variety of graphics / Grande variété des graphismes / Große Vielfalt der Graphiken

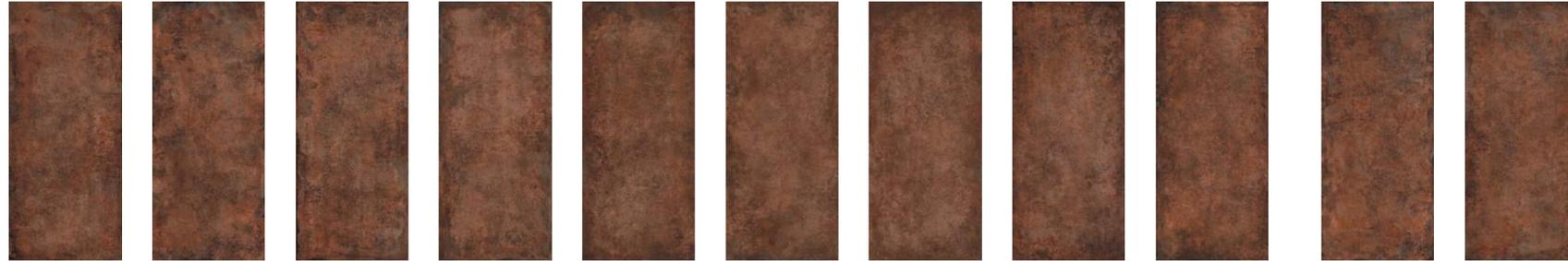

Ambienti unici e originali grazie ad una grande varietà di grafiche.
 The greatly varying patterns featured result in unique and original interiors.
 Des espaces uniques et originaux grâce à une grande variété de graphismes.
 Einzigartige und originelle Räume dank einer großen Vielfalt von Grafiken.

Il numero delle grafiche può variare rispetto a quanto riportato e può essere differente tra i vari formati e/o colori.
 The number of the patterns may differ from that shown herewith and may also vary depending on the selected size and/or colour.
 Le nombre de graphismes peut varier par rapport à ce qui est reporté et il peut varier suivant les différents formats et/ou couleurs.
 Die Anzahl der Grafiken kann von den Angaben abweichen und zwischen den verschiedenen Formaten und/oder Farben unterschiedlich sein.

COLORI

Colours / Couleurs / Farben



PEARL



IRON



CORTEN



OXIDE



TITANIUM

Spessore . Thickness . Epaisseur . Stärke - 6,5 mm

Lastre in gres porcellanato pressate a secco. Dry-pressed porcelain stoneware slabs. Dalles en grès cérame pressées à sec. Trocken gepresste Platten aus Feinsteinzeug.

Spessore . Thickness . Epaisseur . Stärke - 9 mm - 20 mm R11

Gres porcellanato colorato in massa. Full-body coloured porcelain stoneware. Grès cérame coloré dans la masse. In der Masse gefärbtes Feinsteinzeug.

INDOOR - OUTDOOR

TABELLA RIEPILOGATIVA
Summary table
Tableau récapitulatif
Zusammenfassenden Tabelle

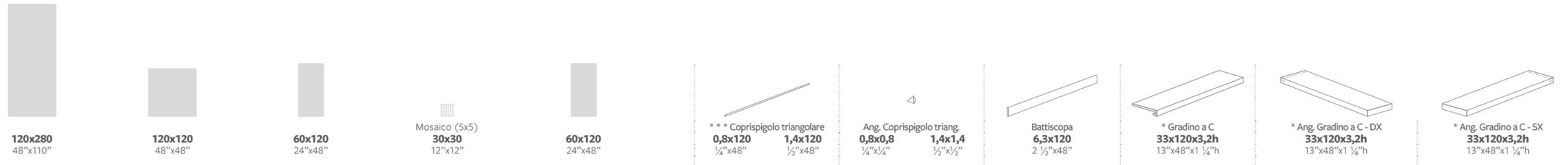

Spessore - Thickness - Epaisseur - Stärke		6,5 mm	6,5 mm	▼ 9 mm	▼ 9 mm	20 mm R11	6,5 mm	▼ 9 mm	6,5 mm	▼ 9 mm	▼ 9 mm	▼ 9 mm	▼ 9 mm	▼ 9 mm
	PEARL □ Nat. Ret.	124040	124070	124090	124250	-	124400	124410	124420	124430	124200	124300	124310	124320
	IRON □ Nat. Ret.	124042	124072	124091	124251	124097	124401	124411	124421	124431	124201	124301	124311	124321
	CORTEN □ Nat. Ret.	124043	124073	124092	124252	124098	124402	124412	124422	124432	124202	124302	124312	124322
	OXIDE □ Nat. Ret.	124041	124071	124093	124253	124099	124403	124413	124423	124433	124203	124303	124313	124323
	TITANIUM □ Nat. Ret.	124044	124074	124094	124254	124100	124404	124414	124424	124434	124204	124304	124314	124324
MQ x pezzo - Sqm x pcs		3,36												
Kg x pezzo - Kg x pcs		53												
IMBALLI - PACKAGING EMBALLAGE - VERPACKUNG														
		Cassa Crate 145x292x34h	Pallet speciale Special pallet 123x144x65h	Pallet 80x120	Pallet 80x120	Pallet 80x120					Pallet 80x120	Pallet 80x120	Pallet 80x120	Pallet 80x120
N°		18									9	2	1	1
m²		60,48												
** Kg		1044												
			2	2	11	1	6	6						
m² x			2,88	1,44	0,99	0,72								
Kg x			45,5	29	19,5	32	1,2	1,8			14,2	21	10,5	10,5
			24	30		30								
m² x			69,12	43,2		21,6								
** Kg x			1145	890		980								
h x			65	75		75								
Imballo (tara) - Packaging (tare)		(90)	(53)	(20)	(20)	(20)					(20)	(20)	(20)	(20)
		Cavalletto A-Frame 75x290x160h												
N°		44												
m²		147,84												
** Kg		2452												
Imballo (tara) - Packaging (tare)		(120)												

I pesi riportati in tabella sono indicativi e potrebbero essere soggetti a leggere variazioni.
The weights stated in the chart may undergo slight changes for production reasons.
Les poids indiqués dans le tableau peuvent subir de légères variations pour des raisons de production.
Die in der Tabelle angegebenen Gewichte können aus Produktionsgründen geringfügigen Abweichungen unterliegen.

Non si garantisce l'abbinabilità tra fondi di spessori diversi e tra fondo e pezzo speciale.
It is not guaranteed that background tiles with different thicknesses can be used together, nor is it guaranteed for background tiles and trims.
Nous ne garantissons pas la possibilité de combiner des carrelages de sol de différentes épaisseurs et un carrelage de sol avec une pièce spéciale.
Die Kombinierbarkeit von Fliesen unterschiedlicher Stärke sowie zwischen Fliese und Formteil kann nicht garantiert werden.

▼ Gli articoli nel nuovo spessore 9 mm saranno disponibili ad esaurimento dello stock esistente in spessore 10 mm.
9 mm items will be available once the current 10 mm stock we have has run out.
Les articles de 9 mm d'épaisseur seront disponibles dès que le stock en 10 mm sera terminé.
Die 9 mm Artikel werden verfügbar sein, sobald die 10 mm Lagerbestände abverkauft sind.

* A disposizione solo su richiesta. Tempi di consegna 30 gg.
Available upon request only. Delivery terms: 30 days.
Disponible seulement sur requête. Délais de livraison: 30 jours.
Verfügbar auf Anfrage. Lieferzeit: 30 Tage.

** Il peso è comprensivo dell'imballo.
The total weight includes the packaging.
Le poids comprend aussi l'emballage.
Das Gesamtgewicht enthält auch die Verpackung.

*** Vendita a scatola completa.
Full box sale.
Vente à la boîte complète.
Volle Kartons.

□ Naturale e rettificato.
Natural rectified.
Natur et rectifié.
Natur Oberfläche und rektifiziert.



OXIDE 60x120 20mm Nat. Ret. R11

PEZZI SPECIALI PER ESTERNO 20 mm R11 - □ Nat. Ret.
Special pieces for outdoor - Pièces spéciales pour extérieur - Formteile für Aussenbereich

Disponibili nei colori Iron, Corten, Oxide e Titanium
Available in Iron, Corten, Oxide and Titanium colours - Disponible dans les couleurs Iron, Corten, Oxide et Titanium - Verfügbar in den Farben Iron, Corten, Oxide und Titanium

 * Gradone 30x120 . 12"x48"	 * Ang. Gradone - SX 30x120 . 12"x48"	 * Ang. Gradone - DX 30x120 . 12"x48"
 * Gradone grip 30x120 . 12"x48"	 * Ang. Gradone grip - SX 30x120 . 12"x48"	 * Ang. Gradone grip - DX 30x120 . 12"x48"
 * Elemento a L 33x120x4h . 13"x48"x1 1/2"h	 * Elemento a L SX 33x120x4h . 13"x48"x1 1/2"h	 * Elemento a L DX 33x120x4h . 13"x48"x1 1/2"h

PEZZI SPECIALI PER PISCINA 20 mm R11 - □ Nat. Ret.
Special pieces for swimming pool - Pièces spéciales pour piscine - Formteile für Schwimmbad

Disponibili nei colori Iron, Corten, Oxide e Titanium
Available in Iron, Corten, Oxide and Titanium colours - Disponible dans les couleurs Iron, Corten, Oxide et Titanium - Verfügbar in den Farben Iron, Corten, Oxide und Titanium

 * Gradone bordo piscina 30x120 . 12"x48"	 * Ang. Gradone bordo piscina - SX 30x120 . 12"x48"	 * Ang. Gradone bordo piscina - DX 30x120 . 12"x48"
 * Gradone grip bordo piscina 30x120 . 12"x48"	 * Ang. Gradone grip bordo piscina - SX 30x120 . 12"x48"	 * Ang. Gradone grip bordo piscina - DX 30x120 . 12"x48"
 * Gradone svasato bordo piscina 30x120 . 12"x48"	 * Ang. Gradone svasato bordo piscina - SX 30x120 . 12"x48"	 * Ang. Gradone svasato bordo piscina - DX 30x120 . 12"x48"
 * Griglia 20x60 . 8"x24"	 * Griglia SX 20x60 . 8"x24"	 * Griglia DX 20x60 . 8"x24"

Per maggiori informazioni su imballi e codici articolo consultare la Sezione Tecnica: "Pezzi speciali per esterno" e "Pezzi speciali per piscina".
For more information on packaging and item codes, please refer to the Technical Section: "Special pieces for outdoor" and "Special pieces for swimming pools".
Pour plus d'informations sur les emballages et les codes articles, vous pouvez consulter la Section Technique: "Pièces spéciales pour extérieur" et "Pièces spéciales pour piscines".
Weitere Informationen für Verpackungen und Artikelcodes finden Sie im Technischen Abschnitt: "Formteile für Außenbereich" und "Formteile für Schwimmbad".

□ Naturale e rettificato.
Natural rectified.
Naturel et rectifié.
Natur Oberfläche und rektifiziert.



Supporti per pavimentazioni sopraelevate nella Sezione "Posa sopraelevata".
Supports for raised paving system, please refer to the Section: "Raised Laying".
Supports pour le système de carrelage surélevé dans la Section "Pose surélevée".
Stelzlager für Doppelboden Wire im Abschnitt "Verlegung auf Stelzlager".

* A disposizione solo su richiesta. Tempi di consegna 30 gg.
Available upon request only. Delivery terms: 30 days.
Disponibile seulement sur requête. Délais de livraison: 30 jours.
Verfügbar auf Anfrage. Lieferzeit: 30 Tage.

▮ Costa retta.
Straight edge.
Bord droit.
Gerade Kante.

▮ Costa toro.
Bullnose edge.
Bord boudin.
Abgerundete Kante.

CONCRETA

Una collezione "effetto cemento" dall'aspetto elegante e sofisticato che interpreta perfettamente la corrente minimalista contemporanea, ancora più accentuata dal grande formato. La texture dall'aspetto glamour e vissuto, volutamente imperfetta, risulta morbida e piacevole al tatto, rispetta le caratteristiche visive del cemento ma con i vantaggi del grès porcellanato anche in una finitura antiscivolo disponibile in 3 colori. Una collezione completa, disponibile in 4 spessori capace di garantire ed esaltare la continuità tra interno ed esterno.

A collection that reproduces a "cement effect" with an elegant and sophisticated look that perfectly interprets the contemporary minimalist current, even more accentuated by the large size. The texture with a glamour and lived-in look, deliberately imperfect, is soft and pleasant to the touch, respects the visual characteristics of the cement but with the advantages of porcelain stoneware also in a antislip finishing available in 3 colours. A complete collection, available in 4 thicknesses, able to guarantee and enhance the continuity between inside and outside.

Une collection « effet béton » au look élégant et sophistiqué qui interprète parfaitement la tendance minimaliste contemporaine, ultérieurement accentuée par le grand format. La texture, à l'aspect glamour et vécu, est volontairement imparfaite, douce et agréable au toucher, respectant les caractéristiques visuelles du béton, mais avec les avantages du grès cérame également dans une finition antidérapante disponible en 3 couleurs. Une collection complète, disponible en 4 épaisseurs, capable de garantir et de renforcer la continuité entre l'intérieur et l'extérieur.

Eine Kollektion mit „Zementeffekt“ und einem eleganten und raffinierten Look, der die zeitgenössische minimalistische Strömung am Besten interpretiert, betont durch das grosse Format. Die Textur mit einem glamour und lebendiges Aussehen, das bewusst nicht perfekt ist, sich weich und angenehm anfühlt, respektiert die optischen Eigenschaften des Zements, aber mit den Vorteilen des Feinsteinzeuges, und ist auch in der rutschhämmenden Oberfläche in 3 Farben verfügbar. Eine komplette Kollektion, verfügbar in 4 Stärken, um die Kontinuität zwischen Innen- und Aussenbereich zu gewährleisten.

100% Made in Italy



RIVESTIMENTO - WALL: GRIGIO SCURO 120x280 Nat. Ret. / GRIGIO SCURO COPRISPIGOLO TRIANGOLARE 0,8x120 Nat. Ret.
 PAVIMENTO - FLOOR: GRIGIO SCURO 120x120 Nat. Ret. - GRIGIO SCURO Mosaico (3x3) 30x30 Nat. Ret.



GRIGIO SCURO 120x120 Nat. Ret.





TERRA 120x120 Nat. Ret.



INDOOR: TERRA 90x90 Nat. Ret.
OUTDOOR: TERRA 90x90 20 mm Nat. Ret. R11

FORMATI

Sizes / Formats / Formate

- 6 mm . 120x280 - 48"x110"
- 9 mm . 120x120 - 48"x48" / 60x120 - 24"x48" / 60x60 - 24"x24" / 30x60 - 12"x24"
- 10 mm . 90x90 - 35 1/2"x35 1/2" / 45x90 - 18"x35 1/2"
- 9 mm R11. 30,2x60,4 - 12"x24"
- 10 mm R11. 45x90 - 18"x35 1/2"
- 20 mm R11. 120x120 - 48"x48" / 90x90 - 35 1/2"x35 1/2" / 60x60 - 24"x24"
- 30 mm R11. 90x90 - 35 1/2"x35 1/2" / 60x60 - 24"x24"

COLORI

Colours / Couleurs / Farben



GRIGIO CHIARO



GRIGIO SCURO



TERRA

CONTINUITÀ PROGETTUALE INDOOR-OUTDOOR

Design continuity indoors and out / Continuité conceptuelle à l'intérieur et à l'extérieur / Entwurfskontinuität im innen-und Aussenbereich



INDOOR

SPESSORE
THICKNESS
6mm

SPESSORE
THICKNESS
9/10mm

Soluzioni contemporanee per l'interior design
Contemporary solutions for interior design.
Solutions contemporaines pour le design intérieur.
Zeitgemäße Lösungen für das Interior Design.



R11
A+B+C

OUTDOOR

SPESSORE
THICKNESS
9/10mm

SPESSORE
THICKNESS
20mm

SPESSORE
THICKNESS
30mm

Versatilità e prestazioni per la progettazione in esterna
Versatility and performance for outdoor design.
Polyvalence et performance pour l'aménagement extérieur.
Vielseitigkeit und Leistungen für Outdoor-Design.

SISTEMI DI POSA

Laying systems / Systemes de pose / Verlegearten

Posa su erba
Laying on grass
Pose sur l'herbe
Verlegung auf Wiese

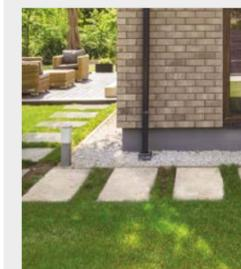

Posa su sabbia
Laying on sand
Pose sur sable
Verlegung auf Sand



Posa sopraelevata
Raised laying
Pose surélevée
Verlegung auf Stelzlager



Posa su ghiaia
Laying on gravel
Pose sur gravier
Verlegung auf Kies



Posa tradizionale
Standard laying
Pose traditionnelle
Herkömmliche Verlegung

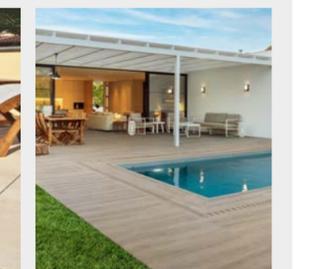

CONCRETA

Spessore . Thickness . Epaisseur . Stärke - 6 mm

Lastre in gres porcellanato pressate a secco. Dry-pressed porcelain stoneware slabs. Dalles en grès cérame pressées à sec. Trocken gepresste Platten aus Feinsteinzeug.

Spessore . Thickness . Epaisseur . Stärke - 9 / 10 mm

Gres porcellanato colorato in massa. Full-body coloured porcelain stoneware. Grès cérame coloré dans la masse. In der Masse gefärbtes Feinsteinzeug.

INDOOR

TABELLA RIEPILOGATIVA
Summary table
Tableau récapitulatif
Zusammenfassende Tabelle

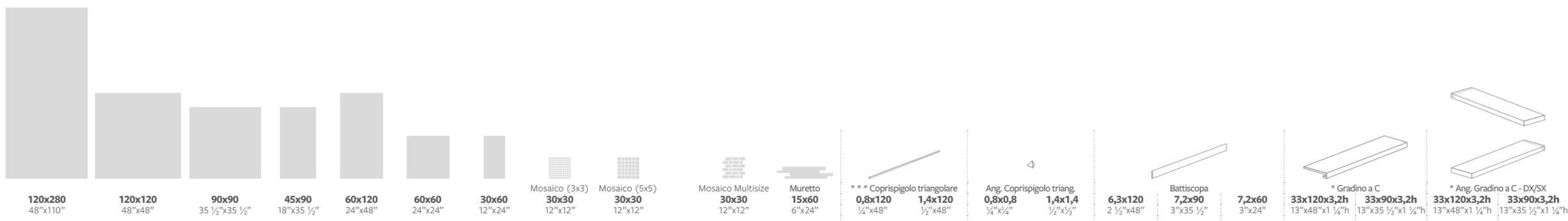

		Spessore - Thickness - Epaisseur - Stärke																						
		6 mm	▼ 9 mm	10 mm	10 mm	▼ 9 mm	▼ 9 mm	▼ 9 mm	▼ 9 mm	▼ 9 mm	▼ 9 mm	▼ 9 mm	▼ 9 mm	6 mm	▼ 9 mm	6 mm	▼ 9 mm	▼ 9 mm	10 mm	▼ 9 mm	▼ 9 mm	10 mm	▼ 9 mm	10 mm
	GRIGIO CHIARO □ Nat. Ret.	119140	119109	119010	119151	119042	119037	119165	119086	119185	119090	119190	119197	119207	119202	119212	119226	119221	119232	119255	119240	DX 119260 SX 119265	DX 119245 SX 119250	
	GRIGIO SCURO □ Nat. Ret.	119141	119107	119009	119152	119041	119035	119166	119085	119186	119089	119191	119198	119208	119203	119213	119227	119222	119233	119256	119241	DX 119261 SX 119266	DX 119246 SX 119251	
	TERRA □ Nat. Ret.	119142	119105	119008	119153	119040	119033	119167	119083	119187	119091	119192	119199	119209	119204	119214	119228	119223	119234	119257	119242	DX 119262 SX 119267	DX 119247 SX 119252	
MQ x pezzo - Sqm x pcs		3,36																						
Kg x pezzo - Kg x pcs		48,6																						
IMBALLI - PACKAGING EMBALLAGE - VERPACKUNG																								
		Cassa Crate 145x292x34h	Pallet speciale Special pallet 123x144	Pallet 94x120	Pallet 94x120	Pallet 80x120	Pallet 80x120	Pallet 80x120	Pallet 80x120	Pallet 80x120	Pallet 80x120	Pallet 80x120	Pallet 80x120	Pallet 80x120	Pallet 80x120	Pallet 80x120	Pallet 80x120	Pallet 80x120	Pallet 80x120	Pallet 80x120	Pallet 80x120	Pallet 80x120	Pallet 80x120	Pallet 80x120
N°		20																						
m²		67,2																						
Kg		1062																						
Imballo (tara) - Packaging (tare)		(90)	(53)	(20)	(20)	(20)	(20)	(20)	(20)	(20)	(20)	(20)	(20)	(20)	(20)	(20)	(20)	(20)	(20)	(20)	(20)	(20)	(20)	(20)
Imballo (tara) - Packaging (tare)																								
		Cavalletto A-Frame 75x290x160h																						
N°		44																						
m²		147,84																						
** Kg		2259																						
Imballo (tara) - Packaging (tare)		(120)																						

I pesi riportati in tabella sono indicativi e potrebbero essere soggetti a leggere variazioni.
The weights stated in the chart may undergo slight changes for production reasons.
Les poids indiqués dans le tableau peuvent subir de légères variations pour des raisons de production.
Die in der Tabelle angegebenen Gewichte können aus Produktionsgründen geringfügigen Abweichungen unterliegen.

Non si garantisce l'abbinabilità tra fondi di spessori diversi e tra fondo e pezzo speciale.
It is not guaranteed that background tiles with different thicknesses can be used together, nor is it guaranteed for background tiles and trims.
Nous ne garantissons pas la possibilité de combiner des carrelages de sol de différentes épaisseurs et un carrelage de sol avec une pièce spéciale.
Die Kombinierbarkeit von Fliesen unterschiedlicher Stärke sowie zwischen Fliese und Formteil kann nicht garantiert werden.

▼ Gli articoli nel nuovo spessore 9 mm saranno disponibili ad esaurimento dello stock esistente in spessore 10 mm.
9 mm items will be available once the current 10 mm stock we have has run out.
Les articles de 9 mm d'épaisseur seront disponibles dès que le stock en 10 mm sera terminé.
Die 9 mm Artikel werden verfügbar sein, sobald die 10 mm Lagerbestände abverkauft sind.

○ Nuova pallettizzazione disponibile ad esaurimento dello stock esistente.
New pallet configuration once current stock fully exhausted.
Nouvelle palettisation disponible jusqu'à épuisement du stock existant.
Neue Palettierung verfügbar solange der Vorrat reicht.

* A disposizione solo su richiesta. Tempi di consegna 30 gg.
Available upon request only. Delivery terms: 30 days.
Disponible seulement sur requête. Délais de livraison: 30 jours.
Verfügbar auf Anfrage. Lieferzeit: 30 Tage.

** Il peso è comprensivo dell'imballo.
The total weight includes the packaging.
Le poids comprend aussi l'emballage.
Das Gesamtgewicht enthält auch die Verpackung.

*** Vendita a scatola completa.
Full box sale.
Vente à la boîte complète.
Volle Kartons.

□ Naturale e rettificato.
Natural rectified.
Naturel et rectifié.
Natur Oberfläche und rektifiziert.

Spessore . Thickness . Epaisseur . Stärke - 9/10 mm R11 - 20 mm R11 - 30 mm R11

Gres porcellanato colorato in massa. Full-body coloured porcelain stoneware. Grès cérame coloré dans la masse. In der Masse gefärbtes Feinsteinzeug.

OUTDOOR

TABELLA RIEPILOGATIVA
Summary table
Tableau récapitulatif
Zusammenfassenden Tabelle

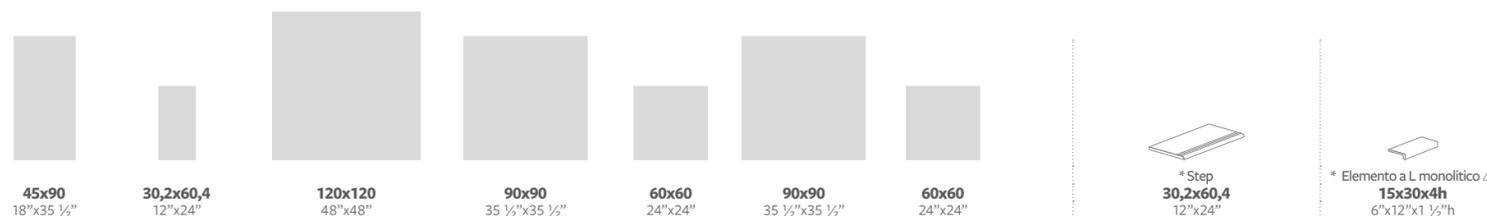

Spessore - Thickness - Epaisseur - Stärke		10 mm R11	▼ 9 mm R11	20 mm R11	20 mm R11	20 mm R11	30 mm R11	30 mm R11	▼ 9 mm R11	9,5 mm R11
	GRIGIO CHIARO	<input type="checkbox"/> Nat. Ret.	119156		119103	119006	119031	119003	119028	
		<input checked="" type="checkbox"/> Nat. Nat.		119175						119270
	GRIGIO SCURO	<input type="checkbox"/> Nat. Ret.	119157		119102	119005	119030	119002	119027	
		<input checked="" type="checkbox"/> Nat. Nat.		119176						119271
	TERRA	<input type="checkbox"/> Nat. Ret.	119158		119101	119004	119029	119001	119026	
		<input checked="" type="checkbox"/> Nat. Nat.		119177						119272
IMBALLI - PACKAGING EMBALLAGE - VERPACKUNG										
		Pallet	Pallet	Pallet speciale Special pallet	Pallet	Pallet	Pallet	Pallet	Pallet	Pallet
		94x120	80x120	123x144	94x94	80x120	95x95	65x125	80x120	80x120
N°										
m²										
Kg										
		3	6	1	1	2	1	1	6	6
m² x		1,22	1,1	1,44	0,81	0,72	0,81	0,36	1,1	
Kg x		27	22,5	64	37	32	55	25	22,5	7,5
		32	40	18	30	32	20	44	40	
m² x		39,04	44	25,92	24,3	23,04	16,2	15,84	44	
** Kg x		884	920	1205	1130	1044	1120	1116	920	
h x		60	76	65	80	75	78	84	76	
Imballo (tara) - Packaging (tare)		(20)	(20)	(53)	(20)	(20)	(20)	(16)	(20)	(20)

I pesi riportati in tabella sono indicativi e potrebbero essere soggetti a leggere variazioni.
The weights stated in the chart may undergo slight changes for production reasons.
Les poids indiqués dans le tableau peuvent subir de légères variations pour des raisons de production.
Die in der Tabelle angegebenen Gewichte können aus Produktionsgründen geringfügigen Abweichungen unterliegen.

Non si garantisce l'abbinabilità tra fondi di spessori diversi e tra fondo e pezzo speciale.
It is not guaranteed that background tiles with different thicknesses can be used together, nor is it guaranteed for background tiles and trims.
Nous ne garantissons pas la possibilité de combiner des carrelages de sol de différentes épaisseurs et un carrelage de sol avec une pièce spéciale.
Die Kombinierbarkeit von Fliesen unterschiedlicher Stärke sowie zwischen Fliese und Formteil kann nicht garantiert werden.

▼ Gli articoli nel nuovo spessore 9 mm saranno disponibili ad esaurimento dello stock esistente in spessore 10 mm.
9 mm items will be available once the current 10 mm stock we have has run out.
Les articles de 9 mm d'épaisseur seront disponibles dès que le stock en 10 mm sera terminé.
Die 9 mm Artikel werden verfügbar sein, sobald die 10 mm Lagerbestände abverkauft sind.

○ Nuova pallettizzazione disponibile ad esaurimento dello stock esistente.
New pallet configuration once current stock fully exhausted.
Nouvelle palettisation disponible jusqu'à épuisement du stock existant.
Neue Palettierung verfügbar solange der Vorrat reicht.

* A disposizione solo su richiesta. Tempi di consegna 30 gg.
Available upon request only. Delivery terms: 30 days.
Disponible seulement sur requête. Délais de livraison: 30 jours.
Verfügbar auf Anfrage. Lieferzeit: 30 Tage.

** Il peso è comprensivo dell'imballo.
The total weight includes the packaging.
Le poids comprend aussi l'emballage.
Das Gesamtgewicht enthält auch die Verpackung.

Naturale e rettificato.
Natural rectified.
Naturel et rectifié.
Natur Oberfläche und rektifiziert.

Naturale e naturale.
Natural and natural.
Naturel et naturel.
Natur natur.

Monolitico
Monolithic step
Monolitico
Monolitische Stufenplatte



INDOOR:
GRIGIO CHIARO 90x90 - Nat. Ret.

OUTDOOR:
GRIGIO CHIARO 90x90 - 20 mm Nat. Ret. R11

Special pieces for swimming pool:
GRIGIO CHIARO GRIGLIA + ANG. 20x60 20 mm Nat. Ret. R11
GRIGIO CHIARO GRADONE SVASATO BORDO PISCINA 30x90 - 20 mm Nat. Ret. R11

PEZZI SPECIALI PER ESTERNO 20 mm R11 - □ Nat. Ret.
Special pieces for outdoor - Pièces spéciales pour extérieur - Formteile für Aussenbereich

	* Gradone 30x120 . 12"x48" 30x90 . 12"x35 1/2" 30x60 . 12"x24"		* Ang. Gradone - SX 30x120 . 12"x48" 30x90 . 12"x35 1/2" 30x60 . 12"x24"		* Ang. Gradone - DX 30x120 . 12"x48" 30x90 . 12"x35 1/2" 30x60 . 12"x24"
	* Gradone grip 30x120 . 12"x48" 30x90 . 12"x35 1/2" 30x60 . 12"x24"		* Ang. Gradone grip - SX 30x120 . 12"x48" 30x90 . 12"x35 1/2" 30x60 . 12"x24"		* Ang. Gradone grip - DX 30x120 . 12"x48" 30x90 . 12"x35 1/2" 30x60 . 12"x24"
	* Elemento a L 33x120x4h 13"x48"x1 1/2"h 33x90x4h 13"x35 1/2"x1 1/2"h 33x60x4h 13"x24"x1 1/2"h		* Elemento a L SX 33x120x4h 13"x48"x1 1/2"h 33x90x4h 13"x35 1/2"x1 1/2"h 33x60x4h 13"x24"x1 1/2"h		* Elemento a L DX 33x120x4h 13"x48"x1 1/2"h 33x90x4h 13"x35 1/2"x1 1/2"h 33x60x4h 13"x24"x1 1/2"h

PEZZI SPECIALI PER PISCINA 20 mm R11 - □ Nat. Ret.
Special pieces for swimming pool - Pièces spéciales pour piscine - Formteile für Schwimmbad

	* Gradone bordo piscina 30x120 . 12"x48" 30x90 . 12"x35 1/2" 30x60 . 12"x24"		* Ang. Gradone bordo piscina - SX 30x120 . 12"x48" 30x90 . 12"x35 1/2" 30x60 . 12"x24"		* Ang. Gradone bordo piscina - DX 30x120 . 12"x48" 30x90 . 12"x35 1/2" 30x60 . 12"x24"
	* Gradone grip bordo piscina 30x120 . 12"x48" 30x90 . 12"x35 1/2" 30x60 . 12"x24"		* Ang. Gradone grip bordo piscina - SX 30x120 . 12"x48" 30x90 . 12"x35 1/2" 30x60 . 12"x24"		* Ang. Gradone grip bordo piscina - DX 30x120 . 12"x48" 30x90 . 12"x35 1/2" 30x60 . 12"x24"
	* Gradone svasato bordo piscina 30x120 . 12"x48" 30x90 . 12"x35 1/2" 30x60 . 12"x24"		* Ang. Gradone svasato bordo piscina - SX 30x120 . 12"x48" 30x90 . 12"x35 1/2" 30x60 . 12"x24"		* Ang. Gradone svasato bordo piscina - DX 30x120 . 12"x48" 30x90 . 12"x35 1/2" 30x60 . 12"x24"
	* Griglia 20x60 . 8"x24"		* Griglia SX 20x60 . 8"x24"		* Griglia DX 20x60 . 8"x24"

Per maggiori informazioni su imballi e codici articolo consultare la Sezione Tecnica: "Pezzi speciali per esterno" e "Pezzi speciali per piscina".
For more information on packaging and item codes, please refer to the Technical Section: "Special pieces for outdoor" and "Special pieces for swimming pools".
Pour plus d'informations sur les emballages et les codes articles, vous pouvez consulter la Section Technique: "Pièces spéciales pour extérieur" et "Pièces spéciales pour piscines".
Weitere Informationen für Verpackungen und Artikelcodes finden Sie im Technischen Abschnitt: "Formteile für Außenbereich" und "Formteile für Schwimmbad".

□ Naturale e rettificato.
Natural rectified.
Naturale et rectifié.
Natur Oberfläche und rektifiziert.



Supporti per pavimentazioni sopraelevate nella Sezione "Posa sopraelevata".
Supports for raised paving system, please refer to the Section: "Raised Laying".
Supports pour le système de carrelage surélevé dans la Section "Pose surélevée".
Stelzlagern für Doppelboden Wäre im Abschnitt "Verlegung auf Stelzlagern".

* A disposizione solo su richiesta. Tempi di consegna 30 gg.
Available upon request only. Delivery terms: 30 days.
Disponibile seulement sur requête. Délais de livraison: 30 jours.
Verfügbar auf Anfrage. Lieferzeit: 30 Tage.

▮ Costa retta.
Straight edge.
Bord droit.
Gerade Kante.

▮ Costa toro.
Bullnose edge.
Bord boudin.
Abgerundete Kante.

APOGEO

APOGEO è un perfetto connubio tra l'effetto materico del cemento e la pietra naturale. Il suo carattere deciso ma allo stesso tempo elegante, perfettamente in sintonia con lo stile moderno, la rende adatta a qualsiasi tipo di ambiente indoor e outdoor: da quello residenziale, a quello commerciale, fino ad arrivare agli spazi dedicati al benessere e all'hospitality.

Collezione estremamente versatile perché declinata in 4 colori sempre di tendenza in diversi formati e spessori: dal formato più grande 120x280 in 6 mm al formato 90x90 disponibile sia in 20 che in 30 mm. Alte performance tecniche e stile elegante in piena continuità progettuale tra ambienti indoor e outdoor.

APOGEO offers a perfect blend of the textures of concrete and natural stone. Its strong yet stylish character, perfectly in tune with today's trends, makes it suitable for any kind of indoor and outdoor setting: from residential to commercial, through to wellness and hospitality.

An extremely versatile collection, it is available in four on-trend colours in a range of sizes and thicknesses, from the largest (a 6 mm-thick slab measuring 120x280) to the smallest (a 90x90 slab, available in both 20 mm and 30 mm thicknesses). Advanced technical performance and stunning looks are combined with seamless continuity between indoor and outdoor designs.

APOGEO est une combinaison parfaite de l'effet matériste du béton et de la pierre naturelle. Grâce à son caractère à la fois décisif et élégant, parfaitement en accord avec le style moderne, cette collection est parfaite pour tout type d'espace intérieur ou extérieur : du résidentiel au commercial, jusqu'aux espaces dédiés au bien-être et aux collectivités.

Elle est extrêmement polyvalente, car elle se décline en 4 couleurs tendance dans différents formats et épaisseurs : du plus grand format 120x280 de 6 mm d'épaisseur au format 90x90 disponible de 20 et 30 mm d'épaisseur. Des performances techniques élevées et un style élégant dans une continuité conceptuelle totale entre les espaces intérieurs et extérieurs.

APOGEO ist eine perfekte Kombination zwischen dem materischen Effekt von Beton und Naturstein. Sein starker, aber gleichzeitig eleganter Charakter, der perfekt auf den modernen Stil abgestimmt ist, macht diese Kollektion für jede Art von Innen- und Außenbereich geeignet: von Wohn- über Gewerberäume bis hin zu Bereichen, die Wellness und Hospitality gewidmet sind.

Eine äußerst vielseitige Kollektion, da sie in 4 trendigen Farben in verschiedenen Formaten und Stärken erhältlich ist: vom größten Format 120x280 in 6 mm bis zum Format 90x90 in 20 in 30 mm Stärke. Hohe technische Leistungen und eleganter Stil in vollkommener Entwurfskontinuität zwischen den Innen- und Außenbereichen.

100% Made in Italy





CONCRETE & DESIGN
COLLECTION

APOGEO



RIVESTIMENTO . WALL: GREY 120x280 Nat. Ret.
Collection DECORS, JAY VINTAGE AZZURRO 120x280 Nat. Ret.
TOP . COUNTERTOP WASHBASINS: GREY 120x280 Nat. Ret.
PAVIMENTO . FLOOR: GREY 120x120 Nat. Ret.



BLACK 90x90 Nat. Ret.



GREY 90x90 Nat. Ret.



FORMATI

Sizes / Formats / Formate

- 6 mm . 120x280 - 48"x110" / 120x120 - 48"x48"
- 9 mm . 60x120 - 24"x48" / 60x60 - 24"x24" / 30x60 - 12"x24"
- 10 mm . 90x90 - 35 1/2"x35 1/2" / 45x90 - 18"x35 1/2"
- 10 mm R11 . 45x90 - 18"x35 1/2"
- 20 mm R11. 90x90 - 35 1/2"x35 1/2" / 60x120 - 24"x48" / 60x60 - 24"x24"
- 30 mm R11. 90x90 - 35 1/2"x35 1/2" / 60x60 - 24"x24"

COLORI

Colours / Couleurs / Farben



WHITE



GREY



ANTHRACITE



BLACK

CONTINUITÀ PROGETTUALE INDOOR-OUTDOOR

Design continuity indoors and out / Continuité conceptuelle à l'intérieur et à l'extérieur / Entwurfskontinuität im innen-und Aussenbereich



INDOOR



Soluzioni contemporanee per l'interior design
Contemporary solutions for interior design.
Solutions contemporaines pour le design intérieur.
Zeitgemäße Lösungen für das Interior Design.



OUTDOOR



Versatilità e prestazioni per la progettazione in esterna
Versatility and performance for outdoor design.
Polyvalence et performance pour l'aménagement extérieur.
Vielseitigkeit und Leistungen für Outdoor-Design.

SISTEMI DI POSA

Laying systems / Systemes de pose / Verlegearten

Posa su erba
Laying on grass
Pose sur l'herbe
Verlegung auf Wiese



Posa su sabbia
Laying on sand
Pose sur sable
Verlegung auf Sand



Posa sopraelevata
Raised laying
Pose surélevée
Verlegung auf Stelzlagern



Posa su ghiaia
Laying on gravel
Pose sur gravier
Verlegung auf Kies



Posa tradizionale
Standard laying
Pose traditionnelle
Herkömmliche Verlegung

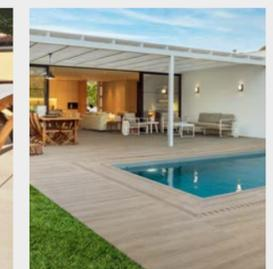

Spessore . Thickness . Epaisseur . Stärke - 10 mm R11 - 20 mm R11 - 30 mm R11

Gres porcellanato colorato in massa. Full-body coloured porcelain stoneware. Grès cérame coloré dans la masse. In der Masse gefärbtes Feinsteinzeug.

OUTDOOR

TABELLA RIEPILOGATIVA
Summary table
Tableau récapitulatif
Zusammenfassenden Tabelle

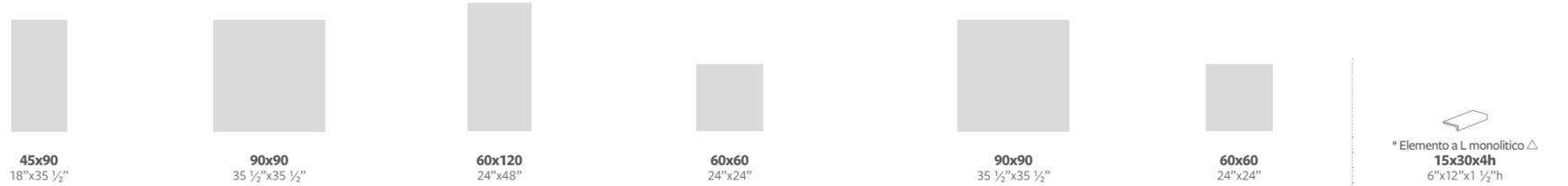

SPESSORE - THICKNESS - EPAISSEUR - STÄRKE		10 mm	20 mm	20 mm	20 mm	30 mm	30 mm	9,5 mm
	□ Nat. Ret.	113205	113102	113171	113150	113119	113162	
	■ Nat. Nat.							113545
	□ Nat. Ret.	113206	113106	113172	113154	113120	113163	
	■ Nat. Nat.							113543
	□ Nat. Ret.	113207	113108	113174	113158	113123	113165	
	■ Nat. Nat.							113544
	□ Nat. Ret.	113208	113107	113173	113157	113121	113164	
	■ Nat. Nat.							113542
IMBALLI - PACKAGING EMBALLAGE - VERPACKUNG								
		Pallet	Pallet	Pallet	Pallet	Pallet	Pallet	Pallet
		94x120	94x94	80x120	80x120	95x95	65x125	80x120
N°								
m²								
Kg								
		3	1	1	2	1	1	6
m² x		1,22	0,81	0,72	0,72	0,81	0,36	
Kg x		27	37	32	32	55	25	7,50
		32	30	30	32	20	44	
m² x		39,04	24,3	21,6	23,04	16,2	15,84	
** Kg x		884	1130	980	1044	1120	1116	
h x		60	80	75	75	78	84	
Imballo (tara) - Packaging (tare)		(20)	(20)	(20)	(20)	(20)	(16)	(20)

I pesi riportati in tabella sono indicativi e potrebbero essere soggetti a leggere variazioni.
The weights stated in the chart may undergo slight changes for production reasons.
Les poids indiqués dans le tableau peuvent subir de légères variations pour des raisons de production.
Die in der Tabelle angegebenen Gewichte können aus Produktionsgründen geringfügigen Abweichungen unterliegen.

Non si garantisce l'abbinabilità tra fondi di spessori diversi e tra fondo e pezzo speciale.
It is not guaranteed that background tiles with different thicknesses can be used together, nor is it guaranteed for background tiles and trims.
Nous ne garantissons pas la possibilité de combiner des carrelages de sol de différentes épaisseurs et un carrelage de sol avec une pièce spéciale.
Die Kombinierbarkeit von Fliesen unterschiedlicher Stärke sowie zwischen Fliese und Formteil kann nicht garantiert werden.

○ Nuova pallettizzazione disponibile ad esaurimento dello stock esistente.
New pallet configuration once current stock fully exhausted.
Nouvelle palettisation disponible jusqu'à épuisement du stock existant.
Neue Palettierung verfügbar solange der Vorrat reicht.

* A disposizione solo su richiesta. Tempi di consegna 30 gg.
Available upon request only. Delivery terms: 30 days.
Disponible seulement sur requête. Délais de livraison: 30 jours.
Verfügbar auf Anfrage. Lieferzeit: 30 Tage.

** Il peso è comprensivo dell'imballo.
The total weight includes the packaging.
Le poids comprend aussi l'emballage.
Das Gesamtgewicht enthält auch die Verpackung.

□ Naturale e rettificato.
Natural rectified.
Naturel et rectifié.
Natur Oberfläche und rektifiziert.

■ Naturale e naturale.
Natural and natural.
Naturel et naturel.
Natur natur.

△ Monolitico.
Monolithic step.
Monolitico.
Monolitische Stufenplatte.

PEZZI SPECIALI PER ESTERNO 20 mm R11 - □ Nat. Ret.

Special pieces for outdoor - Pièces spéciales pour extérieur - Formteile für Aussenbereich

	* Gradone		* Ang. Gradone-SX		* Ang. Gradone-DX
30x120 . 12"x48"	30x90 . 12"x35 1/2"	30x60 . 12"x24"	30x120 . 12"x48"	30x90 . 12"x35 1/2"	30x60 . 12"x24"
	* Gradone grip		* Ang. Gradone grip-SX		* Ang. Gradone grip-DX
30x120 . 12"x48"	30x90 . 12"x35 1/2"	30x60 . 12"x24"	30x120 . 12"x48"	30x90 . 12"x35 1/2"	30x60 . 12"x24"
	* Elemento a L		* Elemento a L SX		* Elemento a L DX
33x120x4h 13"x48"x1 1/2"h	33x90x4h 13"x35 1/2"x1 1/2"h	33x60x4h 13"x24"x1 1/2"h	33x120x4h 13"x48"x1 1/2"h	33x90x4h 13"x35 1/2"x1 1/2"h	33x60x4h 13"x24"x1 1/2"h

PEZZI SPECIALI PER PISCINA 20 mm R11 - □ Nat. Ret.

Special pieces for swimming pool - Pièces spéciales pour piscine - Formteile für Schwimmbad

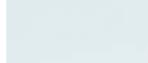
	* Gradone bordo piscina		* Ang. Gradone bordo piscina-SX		* Ang. Gradone bordo piscina-DX
30x120 . 12"x48"	30x90 . 12"x35 1/2"	30x60 . 12"x24"	30x120 . 12"x48"	30x90 . 12"x35 1/2"	30x60 . 12"x24"
	* Gradone grip bordo piscina		* Ang. Gradone grip bordo piscina-SX		* Ang. Gradone grip bordo piscina-DX
30x120 . 12"x48"	30x90 . 12"x35 1/2"	30x60 . 12"x24"	30x120 . 12"x48"	30x90 . 12"x35 1/2"	30x60 . 12"x24"
	* Gradone svasato bordo piscina		* Ang. Gradone svasato bordo piscina-SX		* Ang. Gradone svasato bordo piscina-DX
30x120 . 12"x48"	30x90 . 12"x35 1/2"	30x60 . 12"x24"	30x120 . 12"x48"	30x90 . 12"x35 1/2"	30x60 . 12"x24"
	* Griglia		* Griglia SX		* Griglia DX
20x60 . 8"x24"		20x60 . 8"x24"		20x60 . 8"x24"	

Per maggiori informazioni su imballi e codici articolo consultare la Sezione Tecnica: "Pezzi speciali per esterno" e "Pezzi speciali per piscina".
For more information on packaging and item codes, please refer to the Technical Section: "Special pieces for outdoor" and "Special pieces for swimming pools".
Pour plus d'informations sur les emballages et les codes articles, vous pouvez consulter la Section Technique: "Pièces spéciales pour extérieur" et "Pièces spéciales pour piscines".
Weitere Informationen für Verpackungen und Artikelcodes finden Sie im Technischen Abschnitt: "Formteile für Außenbereich" und "Formteile für Schwimmbad".

□ Naturale e rettificato.
Natural rectified.
Naturel et rectifié.
Natur Oberfläche und rektifiziert.



Supporti per pavimentazioni sopraelevate nella Sezione "Posa sopraelevata".
Supports for raised paving system, please refer to the Section: "Raised Laying".
Supports pour le système de carrelage surélevé dans la Section "Pose surélevée".
Stelzlager für Doppelboden Wäre im Abschnitt "Verlegung auf Stelzlager".

* A disposizione solo su richiesta. Tempi di consegna 30 gg.
Available upon request only. Delivery terms: 30 days.
Disponibile seulement sur requête. Délais de livraison: 30 jours.
Verfügbar auf Anfrage. Lieferzeit: 30 Tage.

┃ Costa retta.
Straight edge.
Bord droit.
Gerade Kante.

┃ Costa toro.
Bullnose edge.
Bord boudin.
Abgerundete Kante.



GREY 60x60 20 mm Nat. Ret. R11

FULL COLOURS

Il bianco e il nero, un sabbia, un grigio classico, un colore scuro caldo, proposti in grandi lastre in porcellanato fino al formato 163x324 cm. Superfici extralucide o lisce naturali, dal 6 mm di spessore fino al 20 mm passando per il 9 ed il 12 mm. Classica intramontabile, contemporanea, attuale e moderna, abbinabile ad ogni contesto sia estetico che tecnico.

FULL COLOURS è tutto questo e molto di più: una collezione "tinte unite" estremamente versatile adatta ad ogni uso dal pavimento o rivestimento, alle pareti ventilate, ai piani cucina, ai tavoli fino al rivestimento di oggetti di design.

Large porcelain stoneware slabs up to size 163x324 cm. Different colours to choose from: sand, black and white, classic grey and a dark warm shade. Extra-bright as well as Matt surfaces and several thickness options, from 6 mm to 20 mm, including 9 mm and 12 mm. Timeless, contemporary, modern.

A perfect match for all types of technical and aesthetic requirements.

FULL COLOURS is all this and much more. It is an extremely versatile range of "solid colours", suitable for virtually every application: floors and walls, ventilated facades, counter tops, tables, design objects.

Un sable, un blanc et un noir, un gris classique, une couleur foncée chaude, proposés en grandes dalles en grès cérame jusqu'au format 163x324 cm. Des surfaces ultra-brillantes ou lisses naturelles de 6 à 20 mm d'épaisseur en passant pour 9 mm et 12 mm. Une série classique intemporelle, contemporaine, actuelle et moderne, indiquée pour toutes les ambiances.

FULL COLOURS est tout cela et bien plus encore, une collection en couleurs unies, extrêmement polyvalente, conçue pour la réalisation des sols et des murs, des façades ventilées, des plans de travail des cuisines, des tables et parfaite pour revêtir tous les objets de design.

Die Farben Sand, Weiß, Schwarz, klassisch Grau und ein warmer Dunkelton sind in Großformat aus Feinsteinzeug bis zu 163x324cm erhältlich. Verfügbare Oberflächen in extra glänzend oder Naturmatt, von 6 über 9 bis hin zu 12 und 20 mm Stärke. Klassisch zeitlos, modern und zeitgemäß, sowohl für ästhetische als auch technische Zwecke einsetzbar.

FULL COLOURS ist all das und vieles mehr, eine Serie aus "Unifarben" geeignet für verschiedene Anwendungen wie Boden- und Wandflächen, Fassaden, Küchenplatten, Tische und Designobjekte.

100% Made in Italy



MOON 120x120 Nat. Ret.



RIVESTIMENTO . WALL: MIDNIGHT 120x280 Lucidato Ret. - Coprispigolo Midnight 0,8x120 Lucidato Ret.
PAVIMENTO . FLOOR: MOON 120x120 Nat. Ret.



RIVESTIMENTO . WALL: SHADOW 120x280 Lucidato Ret / Nat. Ret.
SCALE . STAIRS: CLOUD Nat. Ret. / COPRISPIGOLO TRIANGOLARE CLOUD 0,8x120 Nat. Ret.
PAVIMENTO . FLOOR: CLOUD 120x280 Nat. Ret.



RIVESTIMENTO . WALL:
MOON 120x280 Nat. Ret.
COPRISPIGOLO MOON 0,8x120 Nat. Ret.

PORTA . DOOR:
MOON Nat. Ret. - 6 mm

FIORIERA . FLOWERPOT:
MOON Nat. Ret.

TOP CUCINA . COUNTER TOP
CLOUD Nat. Ret. - 20 mm

ANTE CUCINA . KITCHEN DOORS:
MOON Nat. Ret. - 6 mm

PAVIMENTO . FLOOR:
SHADOW 120x120 Nat. Ret.



RIVESTIMENTO . WALL: MOON 120x280 Nat. Ret.

TAVOLO . TABLE: CLOUD Nat. Ret. - 12 mm

TOP CUCINA . COUNTER TOP: CLOUD Nat. Ret. - 20 mm

ANTE CUCINA . KITCHEN DOORS: MOON Nat. Ret. - 6 mm

PAVIMENTO . FLOOR: SHADOW 120x120 Nat. Ret.

FULL COLOURS

FORMATI

Sizes / Formats / Formate

- 6 mm . 160x320 - 63"x126" / 120x280 - 48"x110" / 120x120 - 48"x48" / 80x80 - 31½"x31½"
- 9 mm . 60x120 - 24"x48"
- ◇ 12 mm . 163x324 - 64"x127"
- 20 mm . 163x324 - 64"x127"

COLORI

Colours / Couleurs / Farben

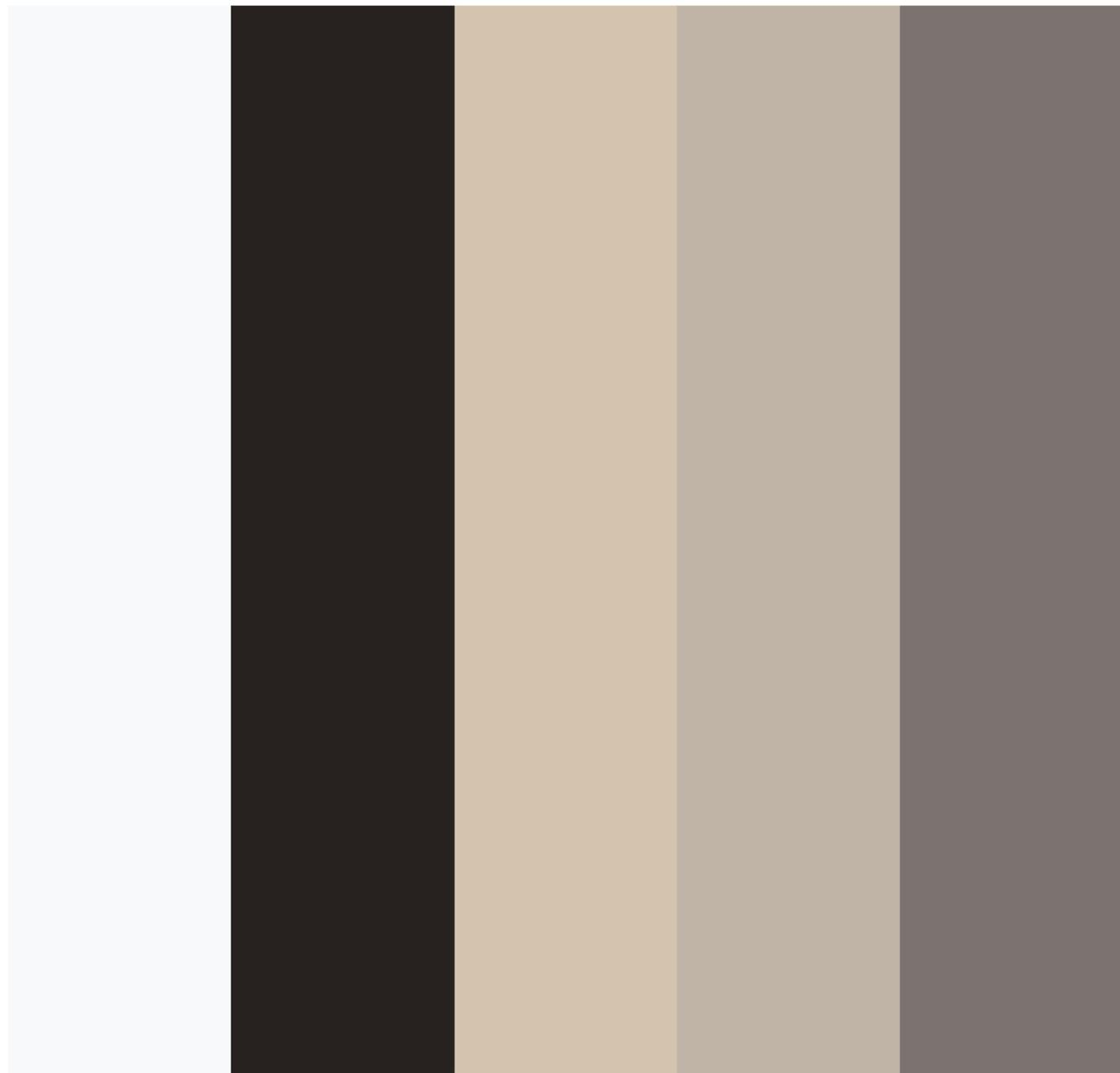

MOON

MIDNIGHT

DESERT

CLOUD

SHADOW

◇ Le lastre con spessore 12 mm vengono fornite sempre stuoiate e non rettificate (dimensioni indicative 163x324 cm).
Lo spessore della stuoia è di 0,7 mm, lo spessore delle lastre stuoiate è di 12,7 mm.

Dry-pressed porcelain stoneware slabs in 12 mm are all mesh-mounted and not rectified (approximate measurements 163x324 cm).
The thickness of the mesh is about 0,7 mm and the thickness of the mesh-mounted slab is 12,7 mm.

Les dalles en épaisseur 12 mm sont fournies toujours sur filet et pas rectifiées (dimensions indicatives 163x324 cm).
L'épaisseur du filet est de 0,7 mm. L'épaisseur de la dalle sur filet est de 12,7 mm.

Die 12mm Großformatplatten werden immer nicht rektifiziert (Maß ungefähr 163x324 cm) und sind mit Glasfasernetz bestückt.
Das Glasfasernetz ist 0,7 mm stark und die Stärke der Platte samt Glasfasernetz beträgt 12,7 mm.

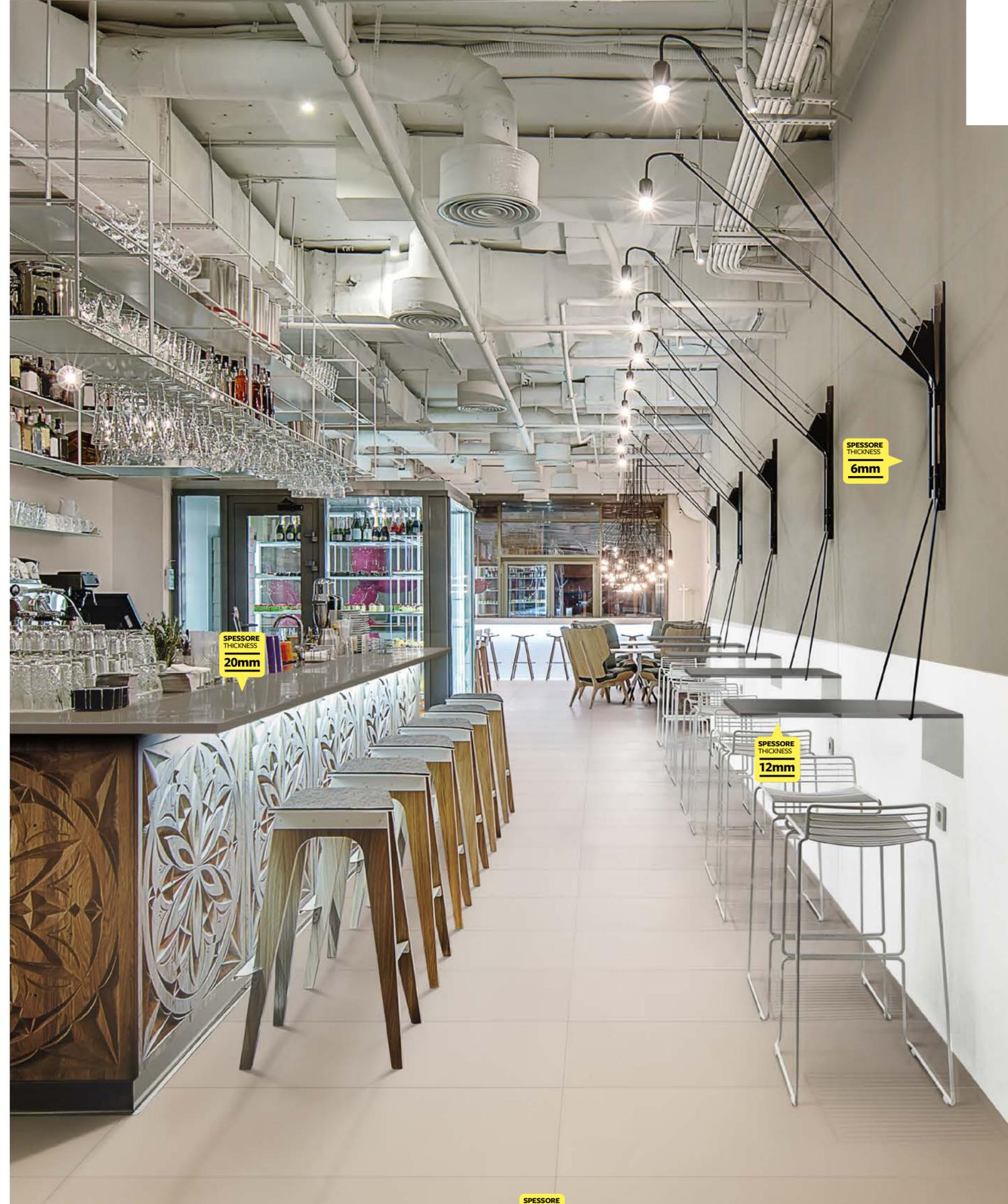

SPESSORE
THICKNESS
20mm

SPESSORE
THICKNESS
6mm

SPESSORE
THICKNESS
12mm

SPESSORE
THICKNESS
9mm

RIVESTIMENTO . WALL: CLOUD 6 mm Nat. Ret. - MOON 6 mm Nat. Ret.

TOP BANCONE . COUNTER TOP: SHADOW 20 mm Lucidato
TAVOLI . TABLES: SHADOW 12 mm Naturale

PAVIMENTO . FLOOR: DESERT 60x120 Nat. Ret.

FULL COLOURS

Spessore . Thickness . Epaisseur . Stärke - 6 mm - 12 mm - 20 mm

Lastre in gres porcellanato pressate a secco . Dry-pressed porcelain stoneware slabs . Dalles en grès cérame pressées à sec . Trocken gepresste Platten aus Feinsteinzeug.

Spessore . Thickness . Epaisseur . Stärke - 9 mm

Gres porcellanato colorato in massa . Full-body coloured porcelain stoneware . Grès cérame coloré dans la masse . In der Masse gefärbtes Feinsteinzeug.

TABELLA RIEPILOGATIVA

Summary table
Tableau récapitulatif
Zusammenfassende Tabelle

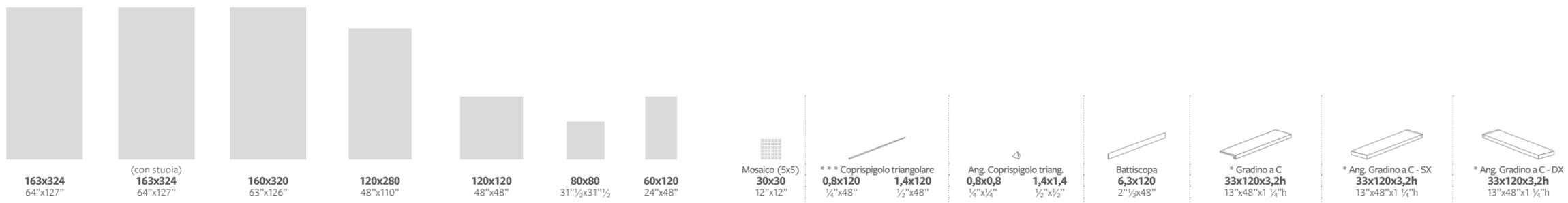

SPESSORE - THICKNESS - EPAISSEUR - STÄRKE		20 mm	12 mm	6 mm	6 mm	6 mm	6 mm	▼ 9 mm	▼ 9 mm	6 mm	▼ 9 mm	6 mm	▼ 9 mm	▼ 9 mm	▼ 9 mm	▼ 9 mm	▼ 9 mm	
MOON	□ Nat. Ret.			109051	109076	109111	109130	109156		109200	109450	109470	109500	109515	109250	109300	109400	109350
	○ Lucidato Ret.			109061	109086	109121	109140	109166		109210	109460	109480	109505	109520	109260	109310	109410	109360
	● Naturale non rettificato	109001	109021															
	○ Lucidato non rettificato	109011	109031															
MIDNIGHT	□ Nat. Ret.			109055	109080	109115	109134	109160		109204	109454	109484	109501	109516	109254	109304	109404	109354
	○ Lucidato Ret.			109065	109090	109125	109144	109170		109214	109464	109494	109506	109521	109264	109314	109414	109364
	● Naturale non rettificato	109005	109025															
	○ Lucidato non rettificato	109015	109035															
MQ x pezzo - Sqm x pcs	5,28	5,28	5,12	3,36														
Kg x pezzo - Kg x pcs	255	153	74,1	48,6														
IMBALLI - PACKAGING EMBALLAGE - VERPACKUNG																		
N°			14	20										9	2	1	1	
m²			71,68	67,2														
** Kg			1158	1062														
					2	3	2	11	6	6					9	2	1	1
m² x					2,88	1,92	1,44	0,99										
Kg x					42	28,1	29	19,5	1,2	1,8					14,2	21	10,5	10,5
m² x					24	40	30											
** Kg x					69,12	76,8	43,2											
h x					1061	1144	890											
Imballo (tara) - Packaging (tare)			(120)	(90)	(53)	(20)	(20)	(20)						(20)	(20)	(20)	(20)	(20)
N°	12	22	44	44														
m²	63,37	116,16	225,28	147,84														
** Kg	3202	3497	3431	2259														
Imballo (tara) - Packaging (tare)	(142)	(142)	(170)	(120)														

▼ Gli articoli nel nuovo spessore 9 mm saranno disponibili ad esaurimento dello stock esistente in spessore 10 mm.
9 mm items will be available once the current 10 mm stock we have has run out.
Les articles de 9 mm d'épaisseur seront disponibles dès que le stock en 10 mm sera terminé.
Die 9 mm Artikel werden verfügbar sein, sobald die 10 mm Lagerbestände abverkauft sind.

* A disposizione solo su richiesta. Tempi di consegna 30 gg.
Available upon request only. Delivery terms: 30 days.
Disponibile seulement sur requête. Délais de livraison: 30 jours.
Verfügbar auf Anfrage. Lieferzeit: 30 Tage.

** Il peso è comprensivo dell'imballo.
The total weight includes the packaging.
Le poids comprend aussi l'emballage.
Das Gesamtgewicht enthält auch die Verpackung.

*** Vendita a scatola completa.
Full box sale.
Vente à la boîte complète.
Volle Kartons.

I pesi riportati in tabella sono indicativi e potrebbero essere soggetti a leggere variazioni.
The weights stated in the chart may undergo slight changes for production reasons.
Les poids indiqués dans le tableau peuvent subir de légères variations pour des raisons de production.
Die in der Tabelle angegebenen Gewichte können aus Produktionsgründen geringfügigen Abweichungen unterliegen.

Non si garantisce l'abbinabilità tra fondi di spessori diversi e tra fondo e pezzo speciale.
It is not guaranteed that background tiles with different thicknesses can be used together, nor is it guaranteed for background tiles and trims.
Nous ne garantissons pas la possibilité de combiner des carrelages de sol de différentes épaisseurs et un carrelage de sol avec une pièce spéciale.
Die Kombinierbarkeit von Fliesen unterschiedlicher Stärke sowie zwischen Fliese und Formteil kann nicht garantiert werden.

□ Naturale e rettificato. Natural rectified. Naturel et rectifié. Natur Oberfläche und rektifiziert.
○ Lucidato e rettificato. Glossy rectified. Brillant et rectifié. Glossy/Shiny und rektifiziert.
● Naturale non rettificato. Natural non-rectified. Naturel non rectifié. Natur nicht rektifiziert.
○ Lucidato non rettificato. Glossy non-rectified. Brillant non rectifié. Glossy/Shiny nicht rektifiziert.

FULL COLOURS

Spessore . Thickness . Epaisseur . Stärke - 6 mm - 12 mm - 20 mm

Lastre in gres porcellanato pressate a secco . Dry-pressed porcelain stoneware slabs . Dalles en grès cérame pressées à sec . Trocken gepresste Platten aus Feinsteinzeug.

Spessore . Thickness . Epaisseur . Stärke - 9 mm

Gres porcellanato colorato in massa . Full-body coloured porcelain stoneware . Grès cérame coloré dans la masse . In der Masse gefärbtes Feinsteinzeug.

TABELLA RIEPILOGATIVA

Summary table
Tableau récapitulatif
Zusammenfassenden Tabelle

		163x324 64"x127"	(con stuoia) 163x324 64"x127"	160x320 63"x126"	120x280 48"x110"	120x120 48"x48"	60x120 24"x48"	Mosaico (5x5) 30x30 12"x12"	*** Coprispigo triangolare 0,8x120 ¼"x48"		Ang. Coprispigo triang. 0,8x0,8 ¼"x¼"		Battiscopa 6,3x120 2"x½"x48"	* Gradino a C 33x120x3,2h 13"x48"x1 ¼"h	* Ang. Gradino a C - SX 33x120x3,2h 13"x48"x1 ¼"h	* Ang. Gradino a C - DX 33x120x3,2h 13"x48"x1 ¼"h
SPESSORE - THICKNESS - EPAISSEUR - STÄRKE		20 mm	12 mm	6 mm	6 mm	6 mm	▼ 9 mm	▼ 9 mm	6 mm	▼ 9 mm	6 mm	▼ 9 mm	▼ 9 mm	▼ 9 mm	▼ 9 mm	▼ 9 mm
DESERT	<input type="checkbox"/> Nat. Ret.			109052	109077	109112	109157	109201	109451	109481	109502	109517	109251	109301	109401	109351
	<input type="checkbox"/> Lucidato Ret.			109062	109087	109122	-	-	109461	-	109507	-	-	-	-	-
	<input checked="" type="checkbox"/> Naturale non rettificato	109002	109022													
	<input type="checkbox"/> Lucidato non rettificato	109012	109032													
CLOUD	<input type="checkbox"/> Nat. Ret.			109053	109078	109113	109158	109202	109452	109482	109504	109518	109252	109302	109402	109352
	<input type="checkbox"/> Lucidato Ret.			109063	109088	109123	-	-	109462	-	109508	-	-	-	-	-
	<input checked="" type="checkbox"/> Naturale non rettificato	109003	109023													
	<input type="checkbox"/> Lucidato non rettificato	109013	109033													
SHADOW	<input type="checkbox"/> Nat. Ret.			109054	109079	109114	109159	109203	109453	109483	109505	109519	109253	109303	109403	109353
	<input type="checkbox"/> Lucidato Ret.			109064	109089	109124	-	-	109463	-	109509	-	-	-	-	-
	<input checked="" type="checkbox"/> Naturale non rettificato	109004	109024													
	<input type="checkbox"/> Lucidato non rettificato	109014	109034													
MQ x pezzo - Sqm x pcs		5,28	5,28	5,12	3,36											
Kg x pezzo - Kg x pcs		255	153	74,1	48,6											
IMBALLI - PACKAGING EMBALLAGE - VERPACKUNG																
				Cassa Crate 175x344x30h	Cassa Crate 145x292x34h	Pallet speciale Special pallet 123x144	Pallet 80x120	Pallet 80x120					Pallet 80x120	Pallet 80x120	Pallet 80x120	Pallet 80x120
N°				14	20								9	2	1	1
m²				71,68	67,2											
** Kg				1158	1062											
						2	2	11	6	6			9	2	1	1
m² x						2,88	1,44	0,99								
Kg x						42	29	19,5	1,2	1,8			14,2	21	10,5	10,5
						24	30									
m² x						69,12	43,2									
** Kg x						1061	890									
h x						65	75									
Imballo (tara) - Packaging (tare)				(120)	(90)	(53)	(20)	(20)					(20)	(20)	(20)	(20)
		Cavalletto in lamiera Iron A-Frame 75x340x185h	Cavalletto in lamiera Iron A-Frame 75x340x185h	Cavalletto in legno Wood A-Frame 75x330x200h	Cavalletto in legno Wood A-Frame 75x290x160h											
N°		12	22	44	44											
m²		63,37	116,16	225,28	147,84											
** Kg		3202	3497	3431	2259											
Imballo (tara) - Packaging (tare)		(142)	(142)	(170)	(120)											

I pesi riportati in tabella sono indicativi e potrebbero essere soggetti a leggere variazioni. The weights stated in the chart may undergo slight changes for production reasons. Les poids indiqués dans le tableau peuvent subir de légères variations pour des raisons de production. Die in der Tabelle angegebenen Gewichte können aus Produktionsgründen geringfügigen Abweichungen unterliegen.

Non si garantisce l'abbinabilità tra fondi di spessori diversi e tra fondo e pezzo speciale. It is not guaranteed that background tiles with different thicknesses can be used together, nor is it guaranteed for background tiles and trims. Nous ne garantissons pas la possibilité de combiner des carrelages de sol de différentes épaisseurs et un carrelage de sol avec une pièce spéciale. Die Kombinierbarkeit von Fliesen unterschiedlicher Stärke sowie zwischen Fliese und Formteil kann nicht garantiert werden.

▼ Gli articoli nel nuovo spessore 9 mm saranno disponibili ad esaurimento dello stock esistente in spessore 10 mm. 9 mm items will be available once the current 10 mm stock we have has run out. Les articles de 9 mm d'épaisseur seront disponibles dès que le stock en 10 mm sera terminé. Die 9 mm Artikel werden verfügbar sein, sobald die 10 mm Lagerbestände abverkauft sind.

* A disposizione solo su richiesta. Tempi di consegna 30 gg. Available upon request only. Delivery terms: 30 days. Disponible seulement sur requête. Délais de livraison: 30 jours. Verfügbar auf Anfrage. Lieferzeit: 30 Tage.

** Il peso è comprensivo dell'imballo. The total weight includes the packaging. Le poids comprend aussi l'emballage. Das Gesamtgewicht enthält auch die Verpackung.

*** Vendita a scatola completa. Full box sale. Vente à la boîte complète. Volle Kartons.

Naturale e rettificato. Natural rectified. Naturel et rectifié. Natur Oberfläche und rektifiziert.

Lucidato e rettificato. Glossy rectified. Brillant et rectifié. Glossy/Shiny und rektifiziert.

Naturale non rettificato. Natural non-rectified. Naturel non rectifié. Natur nicht rektifiziert.

Lucidato non rettificato. Glossy non-rectified. Brillant non rectifié. Glossy/Shiny nicht rektifiziert.

MARBLE & ONYX



Tavola sinottica delle collezioni

Product recap by look, colour and thickness.
Tableau synoptique des collections.
Übersichtstafel.

COLORI 256
COLOURS.
COULEURS.
FARBEN.

COLORI 258
COLOURS.
COULEURS.
FARBEN.

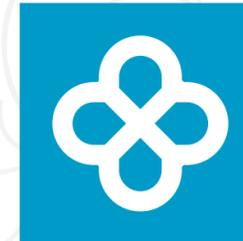
ONICE REALE 260

PATAGONIA 276

ROMA 288

LILAC 304

STATUARIO 310

CALACATTA GOLD 318

SEGESTA 326

MARQUINA 342

TAVOLA SINOTTICA DELLE COLLEZIONI

Product recap by look, colour and thickness . Tableau synoptique des collections . Übersichtstafel.

COLORI

Colours . Couleurs . Farben.

Naturale e rettificato.
Natural rectified.
Naturel et rectifié.
Natur Oberfläche und rektifiziert.

Lucidato e rettificato.
Glossy rectified.
Brillant et rectifié.
Glossy/Shiny und rektifiziert.

Velvet rettificato.
Velvet rectified.
Velvet rectifié.
Velvet rektifiziert.

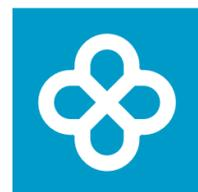

	LILAC PAG. 304	STATUARIO PAG. 310	CRISTALLO ONICE REALE PAG. 260	CALACATTA GOLD PAG. 318	BLU SEGESTA PAG. 326	VERDE SEGESTA PAG. 326	CAMEL SEGESTA PAG. 326	BIANCO PATAGONIA PAG. 276	ARGOS ROMA PAG. 288	
I N D O R 6 mm	160x320 63"x126"	<input type="checkbox"/> Nat. Ret. <input type="radio"/> Luc. Ret.	<input type="checkbox"/> Nat. Ret. <input type="radio"/> Luc. Ret.	<input type="radio"/> Luc. Ret.		<input type="radio"/> Luc. Ret.	<input type="radio"/> Luc. Ret.			
	BOOKMATCH 160x320 63"x126"		<input type="radio"/> Luc. Ret.							
	120x280 48"x110"	<input type="checkbox"/> Nat. Ret. <input type="radio"/> Luc. Ret.	<input type="checkbox"/> Nat. Ret. <input type="radio"/> Luc. Ret.	<input type="radio"/> Luc. Ret.	<input type="checkbox"/> Nat. Ret. <input type="radio"/> Lucidato Ret.	<input type="radio"/> Luc. Ret.	<input type="radio"/> Luc. Ret.	<input type="radio"/> Luc. Ret.		
	BOOKMATCH 120x280 48"x110"		<input type="radio"/> Luc. Ret.							
	120x270 48"x106"							<input type="radio"/> Luc. Ret.		
	120x120 48"x48"	<input type="checkbox"/> Nat. Ret. <input type="radio"/> Luc. Ret.	<input type="checkbox"/> Nat. Ret. <input type="radio"/> Luc. Ret.	<input type="radio"/> Luc. Ret.		<input type="radio"/> Luc. Ret.	<input type="radio"/> Luc. Ret.	<input type="radio"/> Luc. Ret.		
9 mm	80x80 31 1/2"x31 1/2"	<input type="checkbox"/> Nat. Ret. <input type="radio"/> Luc. Ret.	<input type="checkbox"/> Nat. Ret. <input type="radio"/> Luc. Ret.	<input type="radio"/> Luc. Ret.						
	120x120 48"x48"				<input type="checkbox"/> Nat. Ret. <input type="radio"/> Lucidato Ret.			<input type="radio"/> Luc. Ret.		
	80x80 31 1/2"x31 1/2"				<input type="checkbox"/> Nat. Ret. <input type="radio"/> Lucidato Ret.					
	60x120 24"x48"	<input type="checkbox"/> Nat. Ret. <input type="radio"/> Luc. Ret.	<input type="checkbox"/> Nat. Ret. <input type="radio"/> Luc. Ret.	<input type="checkbox"/> Nat. Ret. <input type="radio"/> Lucidato Ret.	<input type="checkbox"/> Nat. Ret. <input type="radio"/> Lucidato Ret.	<input type="checkbox"/> Nat. Ret. <input type="radio"/> Luc. Ret.	<input type="checkbox"/> Nat. Ret. <input type="radio"/> Luc. Ret.	<input type="checkbox"/> Nat. Ret. <input type="radio"/> Luc. Ret.	<input type="checkbox"/> Nat. Ret. <input type="radio"/> Lucidato Ret.	<input type="checkbox"/> Velvet Ret.
	60x60 24"x24"		<input type="checkbox"/> Nat. Ret. <input type="radio"/> Luc. Ret.			<input type="checkbox"/> Nat. Ret. <input type="radio"/> Luc. Ret.	<input type="checkbox"/> Nat. Ret. <input type="radio"/> Luc. Ret.	<input type="checkbox"/> Nat. Ret. <input type="radio"/> Luc. Ret.		
	30x60 12"x24"					<input type="checkbox"/> Nat. Ret. <input type="radio"/> Luc. Ret.	<input type="checkbox"/> Nat. Ret. <input type="radio"/> Luc. Ret.	<input type="checkbox"/> Nat. Ret. <input type="radio"/> Luc. Ret.		<input type="checkbox"/> Velvet Ret.
10x30 4"x12"									<input type="checkbox"/> Velvet Ret.	
7,5x30 3"x12"					<input type="checkbox"/> Nat. Ret. <input type="radio"/> Luc. Ret.	<input type="checkbox"/> Nat. Ret. <input type="radio"/> Luc. Ret.	<input type="checkbox"/> Nat. Ret. <input type="radio"/> Luc. Ret.			

TAVOLA SINOTTICA DELLE COLLEZIONI

Product recap by look, colour and thickness . Tableau synoptique des collections . Übersichtstafel.

COLORI

Colours . Couleurs . Farben.

□ Naturale e rettificato.
Natural rectified.
Naturel et rectifié.
Natur Oberfläche und rektifiziert.

○ Lucidato e rettificato.
Glossy rectified.
Brillant et rectifié.
Glossy/Shiny und rektifiziert.

◇ Velvet rettificato.
Velvet rectified.
Velvet rectifié.
Velvet rektifiziert.



		ROSA ONICE REALE PAG. 260	AMBRA ONICE REALE PAG. 260	CASHMERE PATAGONIA PAG. 276	COLONIA ROMA PAG. 288	OPALE ONICE REALE PAG. 260	SMERALDO ONICE REALE PAG. 260	OCEANO ONICE REALE PAG. 260		FLORENTIA ROMA PAG. 288	TURCHESE PATAGONIA PAG. 276	ZAFFIRO PATAGONIA PAG. 276	CAFFÈ PATAGONIA PAG. 276	NERO MARQUINA PAG. 342	TOLOSA ROMA PAG. 288	EFESO ROMA PAG. 288	
I N D O O R	6 mm	160x320 63"x126"	○ Luc. Ret.	○ Luc. Ret.		○ Luc. Ret.	○ Luc. Ret.	○ Luc. Ret.						○ Luc. Ret.			
		BOOKMATCH 160x320 63"x126"															
		120x280 48"x110"	○ Luc. Ret.	○ Luc. Ret.			○ Luc. Ret.	○ Luc. Ret.	○ Luc. Ret.						○ Luc. Ret.		
		BOOKMATCH 120x280 48"x110"															
		120x270 48"x106"			○ Luc. Ret.							○ Luc. Ret.	○ Luc. Ret.	○ Luc. Ret.			
		120x120 48"x48"	○ Luc. Ret.	○ Luc. Ret.			○ Luc. Ret.	○ Luc. Ret.	○ Luc. Ret.							○ Luc. Ret.	
		80x80 31 1/2"x31 1/2"	○ Luc. Ret.	○ Luc. Ret.		○ Luc. Ret.	○ Luc. Ret.	○ Luc. Ret.						○ Luc. Ret.			
		120x120 48"x48"		○ Luc. Ret.						○ Luc. Ret.	○ Luc. Ret.	○ Luc. Ret.					
		80x80 31 1/2"x31 1/2"															
9 mm	60x120 24"x48"	○ Luc. Ret.	○ Luc. Ret.	○ Luc. Ret.	◇ Velvet Ret.	○ Luc. Ret.	○ Luc. Ret.	○ Luc. Ret.		◇ Velvet Ret.	○ Luc. Ret.	○ Luc. Ret.	○ Luc. Ret.	○ Luc. Ret.	◇ Velvet Ret.	◇ Velvet Ret.	
	60x60 24"x24"																
	30x60 12"x24"				◇ Velvet Ret.					◇ Velvet Ret.					◇ Velvet Ret.	◇ Velvet Ret.	
	10x30 4"x12"				◇ Velvet Ret.					◇ Velvet Ret.					◇ Velvet Ret.	◇ Velvet Ret.	
	7,5x30 3"x12"																

ONICE REALE

ONICE REALE rende tributo a una rara varietà di Onice Persiano: un profondo color smeraldo, reso esclusivo dalla varietà di sfumature e dal caratteristico degradé di toni di colore, dal grigio al bianco, dal verde al bruno.

La collezione, proposta in 6 varianti cromatiche, viene esaltata dall'altissimo valore di gloss portato in dote dall'utilizzo di graniglie, e ulteriormente valorizzato da un'ampia gamma di formati, tra cui il 120x280 cm e lo scenografico 160x320 cm.

ONICE REALE pays homage to a rare variety of Persian Onyx, with its deep emerald tones and the exclusiveness note lent by the differing intensity of the shading and the characteristic use of colour tones ranging from grey to white, green to brown.

The collection, which is available in six colour options, is enhanced by the high-gloss finish created by granular glazes and rendered even more appealing by the wide range of sizes, including the 120x280 cm slab and the stunning 160x320 cm slab.

ONICE REALE rend hommage à une variété rare d'Onyx Persan : une couleur émeraude profonde, rendue exclusive par la variété de nuances et la caractéristique dégradé des tons de couleur, du gris au blanc, du vert au brun.

La collection, disponible en 6 variantes de couleurs, est enrichie par la très haute valeur de brillance due à l'utilisation de grenailles, et ultérieurement valorisée par une large gamme de tailles, dont le 120x280 cm et le spectaculaire 160x320 cm.

ONICE REALE würdigt eine seltene Sorte persischen Onyx: eine tiefe smaragdgrüne Farbe, die durch die Vielfalt der Nuancen und der charakteristischen Abstufung der Farbtöne von Grau bis Weiß, von Grün bis Braun exklusiv wird.

Die in 6 Farbvarianten angebotene Kollektion wird durch den sehr hohen Glanzwert hervorgehoben, der durch die Verwendung von Kieselsteinen entsteht, und durch eine Vielzahl von Formaten, darunter 120x280 cm und die spektakulären 160x320 cm, zusätzlich zur Geltung gebracht.

100% Made in Italy





room
1001
1101





RIVESTIMENTO . WALL: CRISTALLO 120x280 Lucidato Ret. - Collection MARQUINA, NERO 120x280 Lucidato Ret.
PAVIMENTO . FLOOR: CRISTALLO 120x280 Lucidato Ret.
ARREDI . FURNITURE: Collection MARQUINA, NERO Lucidato Ret. - Collection FULL COLOURS, MIDNIGHT Lucidato Ret.









RIVESTIMENTO . WALL: Onice Reale OPALE 160x320 Lucidato Ret.

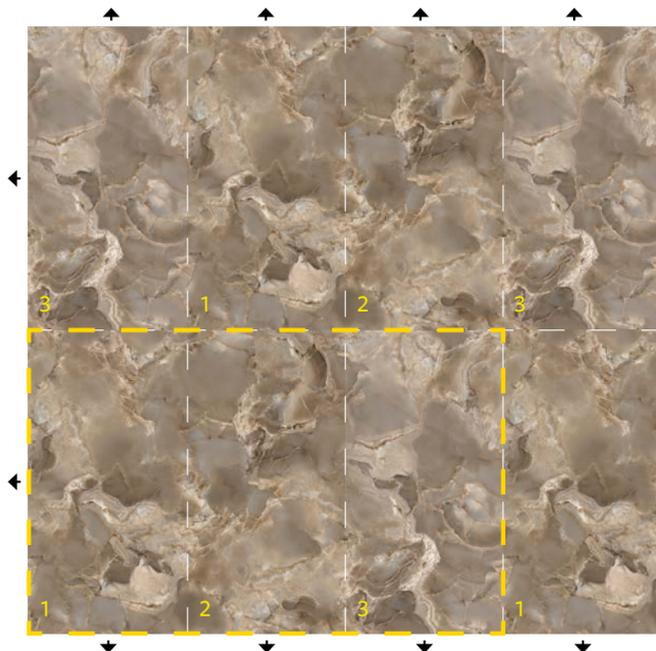

Le grafiche di Onice Reale, nei formati 160x320 e 120x280, sono state studiate per poter essere posate l'una accanto all'altra senza interruzione di vena, sia in senso verticale che orizzontale (discontinuità di grafica max 1,5 cm). Per esigenze di produzione, le 3 grafiche della composizione nel formato 160x320 e le 5 nel 120x280, si trovano random all'interno delle casse e dei cavalletti e non è pertanto garantito che siano tutte presenti o che lo siano in modo proporzionale l'una all'altra. È però possibile ordinare grafiche e composizioni complete a fronte di un ordine minimo di 500 mq con un sovrapprezzo del 10%.

The prints of Onice Reale 160x320 and 120x280 have been designed in such a way as to allow for their veining to carry on horizontally and vertically from one slab to the next with virtually no interruptions - maximum difference 1.5 cm -. For manufacturing reasons, the 3 prints making up the 160x320 set and the 5 prints making up the 120x280 set are randomly placed on crates and A-Frames. For this reason, we are unable to guarantee that all the prints making up each set will be supplied, nor are we able to ensure that the prints will be supplied in equal numbers. It is however possible to order full sets of prints on condition that a minimum order of 500 sqm is placed. A 10% price surcharge will be applied in such cases.

Les graphismes de la série Onice Reale dans les formats 160x320 et 120x280 ont été conçus pour être posés l'un à côté de l'autre sans interruption de veine, soit verticalement que horizontalement (discontinuité de graphisme 1,5 cm max). En faisant suite aux exigences de production, les 3 graphismes de la composition en format 160x320 et les 5 graphismes en format 120x280, sont mélangés par hasard dans les boîtes et les supports. Il n'est donc pas garanti que les graphismes soient tous présents ou bien qu'ils le soient de manière proportionnelle les uns aux autres. Cependant il est possible de commander les graphismes et les compositions complètes. La quantité minimale par commande est de 500 m² avec un supplément de 10%.

Die Großformate in 160x320 und 120x280 des Onice Reale wurden grafisch so ausgelegt, dass sowohl vertikal als auch horizontal eine durchgängige Verlegung der Platten nebeneinander möglich ist, ohne den Verlauf der Aderung zu unterbrechen (höchstens 1,5 cm Abstand zwischen den Grafiken). Aufgrund produktiver Einschränkungen ist das Set aller 3 Grafiken zusammen im Format 160x320 und aller 5 Grafiken in 120x280 in den Kisten und auf Gestell nicht garantiert, weder proportional noch der Anzahl nach. Es besteht jedoch die Möglichkeit volle Sets zu bestellen, bei einer Bestellung von mindestens 500m² mit einem Aufpreis in Höhe von 10%.

FORMATI

Sizes / Formats / Formate

6 mm . 160x320 - 63"x126" / 120x280 - 48"x110" / 120x120 - 48"x48" / 80x80 - 31 ½"x31 ½"
9 mm . 60x120 - 24"x48"

COLORI

Colours / Couleurs / Farben



ROSA



AMBRA



OPALE

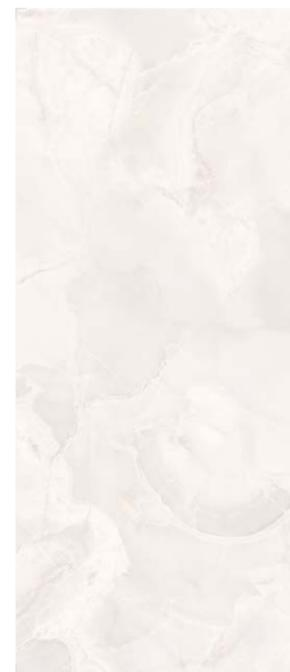

CRISTALLO



SMERALDO



OCEANO

Spessore . Thickness . Epaisseur . Stärke - 6 mm

Lastre in gres porcellanato pressate a secco. Dry-pressed porcelain stoneware slabs. Dalles en grès cérame pressées à sec. Trocken gepresste Platten aus Feinsteinzeug.

Spessore . Thickness . Epaisseur . Stärke - 9 mm

Gres porcellanato colorato in massa. Full-body coloured porcelain stoneware. Grès cérame coloré dans la masse. In der Masse gefärbtes Feinsteinzeug.

GRANDI VARIETÀ DI GRAFICHE

Wide variety of graphics / Grande variété des graphismes / Große Vielfalt der Graphiken



Ambienti unici e originali grazie ad una grande varietà di grafiche.
The greatly varying patterns featured result in unique and original interiors.
Des espaces uniques et originaux grâce à une grande variété de graphismes.
Einzigartige und originelle Räume dank einer großen Vielfalt von Grafiken.

Il numero delle grafiche può variare rispetto a quanto riportato e può essere differente tra i vari formati e/o colori.
The number of the patterns may differ from that shown herewith and may also vary depending on the selected size and/or colour.
Le nombre de graphismes peut varier par rapport à ce qui est reporté et il peut varier suivant les différents formats et/ou couleurs.
Die Anzahl der Grafiken kann von den Angaben abweichen und zwischen den verschiedenen Formaten und/oder Farben unterschiedlich sein.

TABELLA RIEPILOGATIVA

Summary table
Tableau récapitulatif
Zusammenfassende Tabelle

	SPESORE - THICKNESS - EPAISSEUR - STÄRKE	6 mm		6 mm		▼ 9 mm		▼ 9 mm		▼ 9 mm		▼ 9 mm		▼ 9 mm		▼ 9 mm	
		6 mm	6 mm	6 mm	6 mm	▼ 9 mm	▼ 9 mm	▼ 9 mm	▼ 9 mm	▼ 9 mm	▼ 9 mm	▼ 9 mm	▼ 9 mm	▼ 9 mm	▼ 9 mm	▼ 9 mm	▼ 9 mm
CRISTALLO	○ Lucidato Ret. □ Nat. Ret.	108020	108040	108070	108080	108090	108110	108180	108190	108206	108226	108130	108150	108160	108170		
ROSA	○ Lucidato Ret.	108021	108041	108071	108081	108091	108111	108181	108191	108207	108227	108131	108151	108161	108171		
OPALE	○ Lucidato Ret.	108022	108042	108072	108082	108092	108112	108182	108192	108208	108228	108132	108152	108162	108172		
AMBRA	○ Lucidato Ret.	108023	108043	108073	108083	108093	108113	108183	108193	108209	108229	108133	108153	108163	108173		
OCEANO	○ Lucidato Ret.	108024	108044	108074	108084	108094	108114	108184	108194	108210	108230	108134	108154	108164	108174		
SMERALDO	○ Lucidato Ret.	108025	108045	108075	108085	108095	108115	108185	108195	108211	108231	108135	108155	108165	108175		
MQ x pezzo - Sqm x pcs		5,12	3,36														
Kg x pezzo - Kg x pcs		74,1	48,6														
IMBALLI - PACKAGING																	
EMBALLAGE - VERPACKUNG																	
		Cassa Crate 175x344x30h	Cassa Crate 145x292x34h	Pallet speciale Special pallet 123x144	Pallet 80x120	Pallet 80x120	Pallet 80x120					Pallet 80x120	Pallet 80x120	Pallet 80x120	Pallet 80x120		
N°		14	20														
m²		71,68	67,2														
** Kg		1158	1062														
Icon				2	3	2	11	6	6			9	2	1	1		
m² x				2,88	1,92	1,44	0,99										
Kg x				42	28,1	29	19,5	1,2	1,8			14,2	21	10,5	10,5		
m² x				69,12	76,8	43,2											
** Kg x				1061	1144	890											
h x				65	95	75											
Imballo (tara) - Packaging (tare)		(120)	(90)	(53)	(20)	(20)	(20)					(20)	(20)	(20)	(20)		
		Cavalletto A-Frame 75x330x200h	Cavalletto A-Frame 75x290x160h														
N°		44	44														
m²		225,28	147,84														
** Kg		3431	2259														
Imballo (tara) - Packaging (tare)		(170)	(120)														

I pesi riportati in tabella sono indicativi e potrebbero essere soggetti a leggere variazioni.
The weights stated in the chart may undergo slight changes for production reasons.
Les poids indiqués dans le tableau peuvent subir de légères variations pour des raisons de production.
Die in der Tabelle angegebenen Gewichte können aus Produktionsgründen geringfügigen Abweichungen unterliegen.

Non si garantisce l'abbinabilità tra fondi di spessori diversi e tra fondo e pezzo speciale.
It is not guaranteed that background tiles with different thicknesses can be used together, nor is it guaranteed for background tiles and trims.
Nous ne garantissons pas la possibilité de combiner des carrelages de sol de différentes épaisseurs et un carrelage de sol avec une pièce spéciale.
Die Kombinierbarkeit von Fliesen unterschiedlicher Stärke sowie zwischen Fliese und Formteil kann nicht garantiert werden.

▼ Gli articoli nel nuovo spessore 9 mm saranno disponibili ad esaurimento dello stock esistente in spessore 10 mm.
9 mm items will be available once the current 10 mm stock we have has run out.
Les articles de 9 mm d'épaisseur seront disponibles dès que le stock en 10 mm sera terminé.
Die 9 mm Artikel werden verfügbar sein, sobald die 10 mm Lagerbestände abverkauft sind.

* A disposizione solo su richiesta. Tempi di consegna 30 gg.
Available upon request only. Delivery terms: 30 days.
Disponible seulement sur requête. Délais de livraison: 30 jours.
Verfügbar auf Anfrage. Lieferzeit: 30 Tage.

** Il peso è comprensivo dell'imballo. The total weight includes the packaging. Le poids comprend aussi l'emballage. Das Gesamtgewicht enthält auch die Verpackung.

*** Vendita a scatola completa. Full box sale. Vente à la boîte complète. Volle Kartons.

□ Naturale e rettificato. Natural rectified. Naturel et rectifié. Natur Oberfläche und rektifiziert.

○ Lucidato e rettificato. Glossy rectified. Brillant et rectifié. Glossy/Shiny und rektifiziert.

PATAGONIA

PATAGONIA by **Tagina** è un'interpretazione originale della pietra vulcanica sudamericana da cui prende il nome. Liberata dai blocchi di fredda durezza con grande sensibilità e certosina maestria, prende forma e vita un marmo nuovo, un cristallo dagli effetti grafici di rara bellezza dove note cromatiche formano intrecci e venature su sfondi traslucidi, componendo superfici tra le più scenografiche nel suo genere, il tutto esaltato dal formato della grande lastra 120x270 in cui è disponibile.

PATAGONIA by **Tagina** is an original interpretation of the South American volcanic stone from which it takes its name. Freed from blocks of cold hardness with great sensitivity and painstaking craftsmanship, a new marble takes shape and life, a crystal with graphic effects of rare beauty where chromatic notes form weaves and veins on translucent backgrounds, composing surfaces that are among the most spectacular of its kind. All enhanced by the size of the large 120x270 slab in which it is available.

PATAGONIA by **Tagina** est une interprétation originale de la pierre volcanique sud-américaine dont elle tire son nom. Libéré des blocs de dureté froide avec une grande sensibilité et un travail artisanal méticuleux, un nouveau marbre prend forme, un cristal aux effets graphiques d'une rare beauté où les notes chromatiques forment des entrelacements et des veines sur des fonds translucides, composant des surfaces parmi les plus scéniques, le tout mis en valeur par les dimensions de la grande dalle 120x270 disponible.

PATAGONIA by **Tagina** ist eine originelle Interpretation des südamerikanischen Vulkangesteins, von dem es seinen Namen hat. Mit viel Fingerspitzengefühl und handwerklichem Geschick aus harten Blöcken gewonnen, nimmt ein neuer Marmor Gestalt und Leben an, ein Kristall mit grafischen Effekten von seltener Schönheit, bei dem chromatische Töne auf durchscheinendem Grund Geflechte und Maserungen bilden, die zu den spektakulärsten Oberflächen seiner Art gehören, was durch die Größe der 120x270-Platte, in der er erhältlich ist, noch verstärkt wird.

100% Made in Italy

RIVESTIMENTO . WALL: TURCHESE 120x270 Lucidato Ret. - Collection METAL CORTEN 120x280 Nat. Ret.
BANCONE . COUNTER: TURCHESE 120x270 Lucidato Ret. - Collection METAL CORTEN 120x280 Nat. Ret.
PAVIMENTO . FLOOR: TURCHESE 120x270 Lucidato Ret.









RIVESTIMENTO . WALL: CAFFE' 120x270 Lucidato Ret.
PAVIMENTO . FLOOR: CAFFE' 120x270 Lucidato Ret.

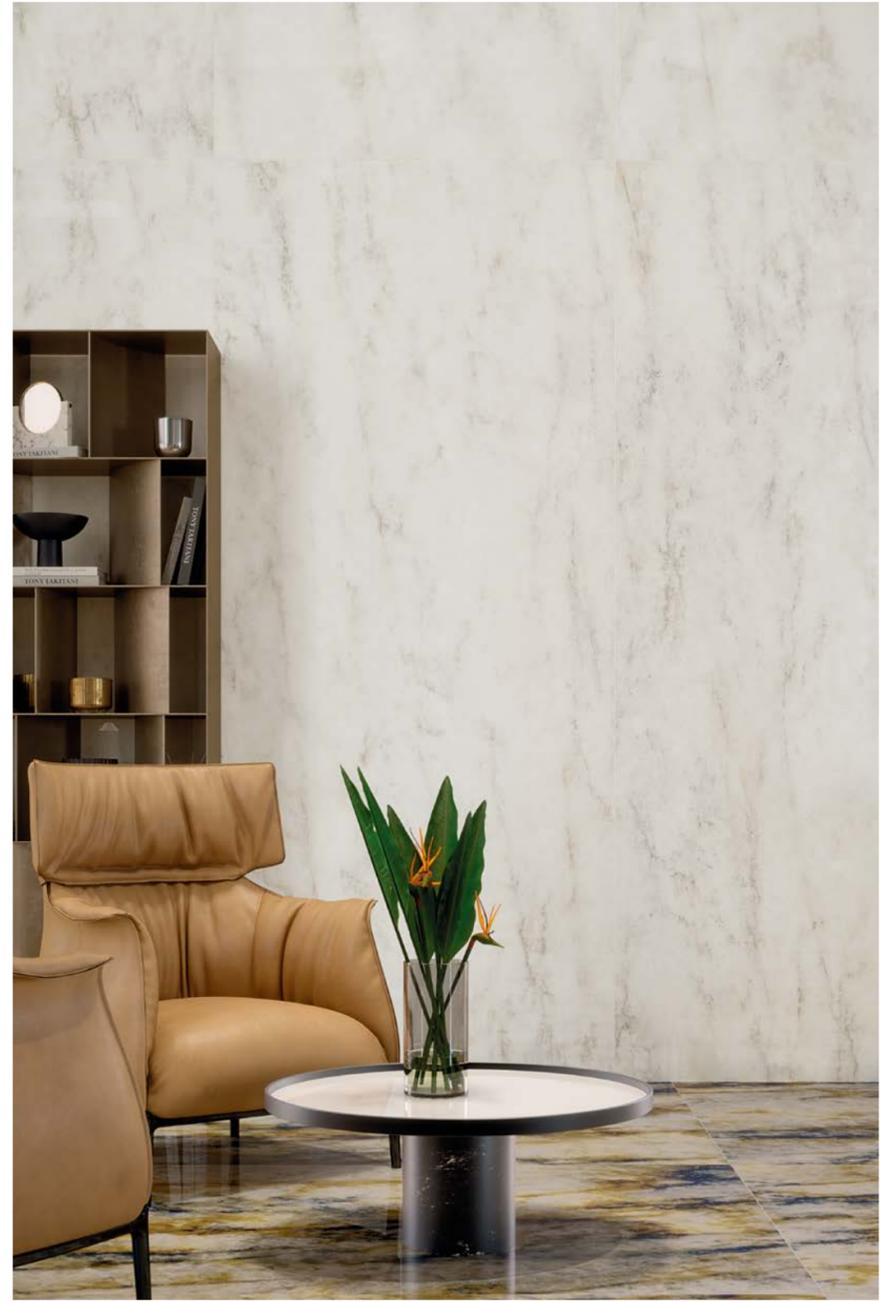

RIVESTIMENTO . WALL: BIANCO 120x270 Lucidato Ret.
PAVIMENTO . FLOOR: ZAFFIRO 120x270 Lucidato Ret.

FORMATI

Sizes / Formats / Formate

6 mm . 120x270 - 48"x106"
9 mm . 120x120 - 48"x48" / 60x120 - 24"x48"

GRANDI VARIETÀ DI GRAFICHE

Wide variety of graphics / Grande variété des graphismes / Große Vielfalt der Graphiken



Ambienti unici e originali grazie ad una grande varietà di grafiche.
The greatly varying patterns featured result in unique and original interiors.
Des espaces uniques et originaux grâce à une grande variété de graphismes.
Einzigartige und originelle Räume dank einer großen Vielfalt von Grafiken.

Il numero delle grafiche può variare rispetto a quanto riportato e può essere differente tra i vari formati e/o colori.
The number of the patterns may differ from that shown herewith and may also vary depending on the selected size and/or colour.
Le nombre de graphismes peut varier par rapport à ce qui est reporté et il peut varier suivant les différents formats et/ou couleurs.
Die Anzahl der Grafiken kann von den Angaben abweichen und zwischen den verschiedenen Formaten und/oder Farben unterschiedlich sein.

COLORI

Colours / Couleurs / Farben



BIANCO



CASHMERE



ZAFFIRO



TURCHESE



CAFFÈ

Spessore . Thickness . Epaisseur . Stärke - 6 mm

Lastre in gres porcellanato pressate a secco. Dry-pressed porcelain stoneware slabs. Dalles en grès cérame pressées à sec. Trocken gepresste Platten aus Feinsteinzeug.

Spessore . Thickness . Epaisseur . Stärke - 9 mm

Gres porcellanato colorato in massa. Full-body coloured porcelain stoneware. Grès cérame coloré dans la masse. In der Masse gefärbtes Feinsteinzeug.

TABELLA RIEPILOGATIVASummary table
Tableau récapitulatif
Zusammenfassende Tabelle

SPESSORE - THICKNESS - EPAISSEUR - STÄRKE		6 mm	9 mm	9 mm	9 mm	6 mm	9 mm	6 mm	9 mm	9 mm	9 mm	9 mm	9 mm
	○ Lucidato Ret.	125071	125091	125101	125200	125400	125420	125410	125430	125250	125300	125310	125320
	□ Nat. Ret.	-	-	125102	-	-	125421	-	125435	125251	125301	125311	125321
	○ Lucidato Ret.	125072	125092	125103	125202	125402	125422	125411	125431	125252	125302	125312	125322
	○ Lucidato Ret.	125073	125093	125105	125204	125404	125424	125412	125432	125254	125304	125314	125324
	○ Lucidato Ret.	125074	125094	125107	125206	125406	125426	125413	125433	125256	125306	125316	125326
	○ Lucidato Ret.	125075	125095	125109	125208	125408	125428	125414	125434	125258	125308	125318	125328
MQ x pezzo - Sqm x pcs		3,24											
Kg x pezzo - Kg x pcs		47											
IMBALLI - PACKAGING EMBALLAGE - VERPACKUNG													
		Cassa Crate 132x291x38h	Pallet speciale Special pallet 123x144	Pallet 90x120	Pallet 80x120					Pallet 80x120	Pallet 80x120	Pallet 80x120	Pallet 80x120
N°		20											
m²		64,8											
** Kg		1020											
 x			2	2	11	6	6			9	2	1	1
m² x			2,88	1,44	0,99								
Kg x			58	29	19,5	1,2	1,8			14,2	21	10,5	10,5
 x			18	35									
m² x			51,84	50,4									
** Kg x			1097	1035									
h x			65	75									
Imballo (tara) - Packaging (tare)		(80)	(53)	(20)	(20)					(20)	(20)	(20)	(20)
													
		Cavalletto A-Frame 75x290x160h											
N°		44											
m²		142,56											
** Kg		2188											
Imballo (tara) - Packaging (tare)		(120)											

I pesi riportati in tabella sono indicativi e potrebbero essere soggetti a leggere variazioni.
The weights stated in the chart may undergo slight changes for production reasons.
Les poids indiqués dans le tableau peuvent subir de légères variations pour des raisons de production.
Die in der Tabelle angegebenen Gewichte können aus Produktionsgründen geringfügigen Abweichungen unterliegen.

Non si garantisce l'abbinabilità tra fondi di spessori diversi e tra fondo e pezzo speciale.
It is not guaranteed that background tiles with different thicknesses can be used together, nor is it guaranteed for background tiles and trims.
Nous ne garantissons pas la possibilité de combiner des carrelages de sol de différentes épaisseurs et un carrelage de sol avec une pièce spéciale.
Die Kombinierbarkeit von Fliesen unterschiedlicher Stärke sowie zwischen Fliese und Formteil kann nicht garantiert werden.

* A disposizione solo su richiesta. Tempi di consegna 30 gg.
Available upon request only. Delivery terms: 30 days.
Disponible seulement sur requête. Délais de livraison: 30 jours.
Verfügbar auf Anfrage. Lieferzeit: 30 Tage.

** Il peso è comprensivo dell'imballo.
The total weight includes the packaging.
Le poids comprend aussi l'emballage.
Das Gesamtgewicht enthält auch die Verpackung.

*** Vendita a scatola completa.
Full box sale.
Vente à la boîte complète.
Volle Kartons.

□ Naturale e rettificato.
Natural rectified.
Naturel et rectifié.
Natur Oberfläche und rektifiziert.

○ Lucidato e rettificato.
Glossy rectified.
Brillant et rectifié.
Glossy/Shiny und rektifiziert.

ROMA

Pregiati travertini italiani, sinuosi onici mediorientali, variegati marmi africani: i materiali più ricchi e preziosi dei domini romani li troviamo nei rivestimenti di uno dei più affascinanti monumenti dell'impero: il Pantheon. Una molteplicità di generi e stili come a rappresentare la diversità tra tutti gli Dei ai quali tale tempio era dedicato. Sono questi stili, questi colori, questa forza che hanno ispirato la collezione **ROMA**, una serie classica e preziosa che ha saputo domare e fondere in un progetto unico quanto originale tutti i diversi caratteri distintivi di ciascuno di questi superbi materiali naturali.

Fine Italian travertine, sinuous Middle Eastern onyx, variegated African marble: the richest and most precious materials of the Romans can be found in the coverings of one of the most fascinating monuments of the empire: the Pantheon. A multiplicity of genres and styles as if to represent the diversity of all the Gods this temple was dedicated to. It is these styles, these colours, this strength that inspired the **ROMA** collection, a classic and precious series that has been able to tame and merge into a unique and original project all the different distinctive features of each of these superb natural materials.

Précieus travertins italiens, onyx sinueux du Moyen-Orient, marbres africains chamarrés : les matériaux les plus riches et les plus précieux des domaines romains se retrouvent dans le revêtement de l'un des monuments les plus fascinants de l'empire : le Panthéon. Une multitude de genres et de styles comme pour représenter la diversité de tous les dieux auxquels ce temple était dédié. Ce sont ces styles, ces couleurs, cette force qui ont inspiré la collection **ROMA**, une série classique et précieuse qui a su apprivoiser et fusionner tous les différents traits distinctifs de chacun de ces superbes matériaux naturels en un projet unique et original.

Kostbare italienische Travertine, gewundene Onyx aus dem Nahen Osten, vielfältig melierter afrikanischer Marmor: die reichsten und kostbarsten Materialien der römischen Domänen finden sich in der Verkleidung eines der faszinierendsten Monumente des Reiches wieder: dem Pantheon. Eine Vielzahl von Genres und Stilen, als ob sie die Vielfalt aller Götter, denen dieser Tempel gewidmet war, darstellen sollte. Es sind diese Stile, diese Farben, diese Kraft, die die Kollektion **ROMA** inspiriert haben, eine klassische und hochwertige Serie, die es verstanden hat, die unterschiedlichen Merkmale dieser herrlichen Naturmaterialien zu bändigen und in einem ebenso einzigartigen wie originellen Design zu vereinen.

100% Made in Italy

RIVESTIMENTO - WALL:
COLONIA 30x60 Velvet Ret.
Mosaico Appia COLONIA 27,6x27,6 Velvet Ret.
Coprispigolo Triangolare COLONIA 1,4x120 Velvet Ret.

PAVIMENTO - FLOOR:
COLONIA 60x120 Velvet Ret.
Mosaico Appia COLONIA 27,6x27,6

MOBILE BAGNO - Vanity:
Collection EVOQUE, BAHIA 26,5x180 Nat. Ret.

Angolo SPA - SPA Area
Mosaico Appia COLONIA 27,6x27,6
Collection EVOQUE, BAHIA 20x120 Nat. Ret.







RIVESTIMENTO - WALL: TOLOSA 60x120 Velvet Ret.
BANCONE - COUNTER: Collection APOGEO, WHITE Nat. Ret. 6 mm
PAVIMENTO - FLOOR: ARGOS 60x120 Velvet Ret. - TOLOSA 60x120 Velvet Ret.



RIVESTIMENTO . WALL: Mosaico Esagona ARGOS 28x29 Velvet Ret. - FLORENTIA 60x120 Velvet Ret.
PAVIMENTO . FLOOR: ARGOS 60x120 Velvet Ret.



RIVESTIMENTO . WALL: Mosaico Esagona FLORENTIA 28x29 Velvet Ret. - FLORENTIA 60x120 Velvet Ret.
PAVIMENTO . FLOOR: FLORENTIA 60x120 Velvet Ret.

FORMATI
Sizes / Formats / Formate

9 mm . 60x120 - 24"x48" / 30x60 - 12"x24" / 10x30 - 4"x12"

COLORI
Colours / Couleurs / Farben



ARGOS



COLONIA



EFESO



TOLOSA



FLORENTIA



RIVESTIMENTO . WALL:
FLORENTIA 10x30 Velvet Ret.

PAVIMENTO . FLOOR:
FLORENTIA 60x120 Velvet Ret.

Spessore . Thickness . Epaisseur . Stärke - 9 mm
Gres porcellanato colorato in massa. Full-body coloured porcelain stoneware. Grès cérame coloré dans la masse. In der Masse gefärbtes Feinsteinzeug.

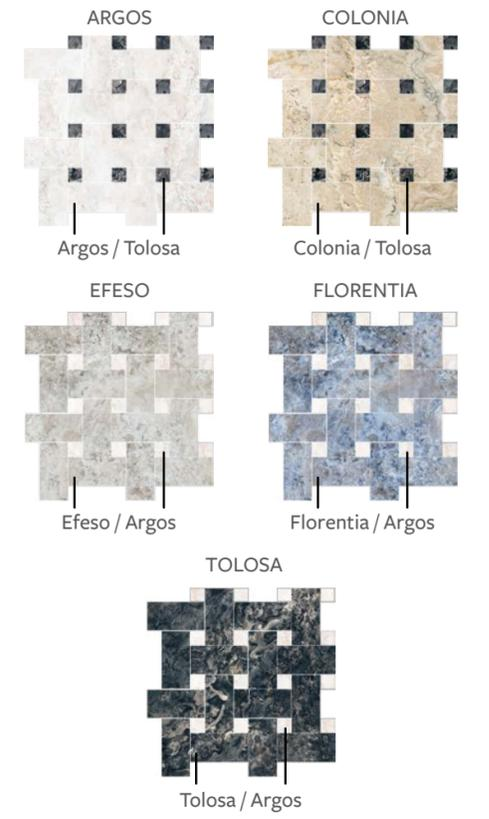
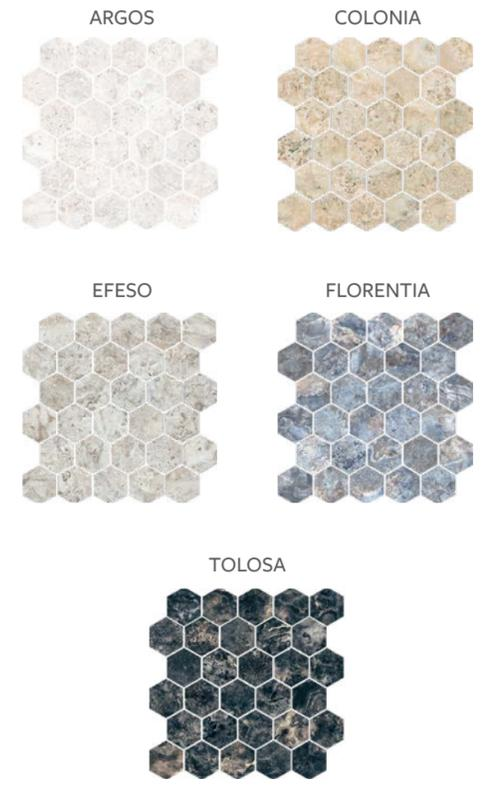
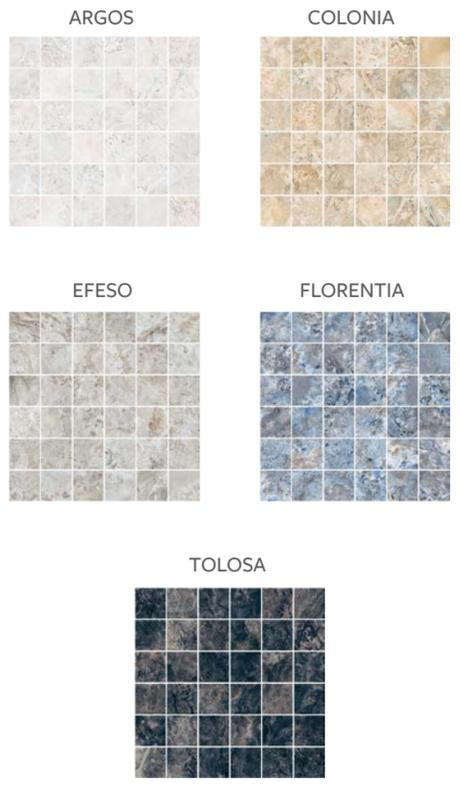
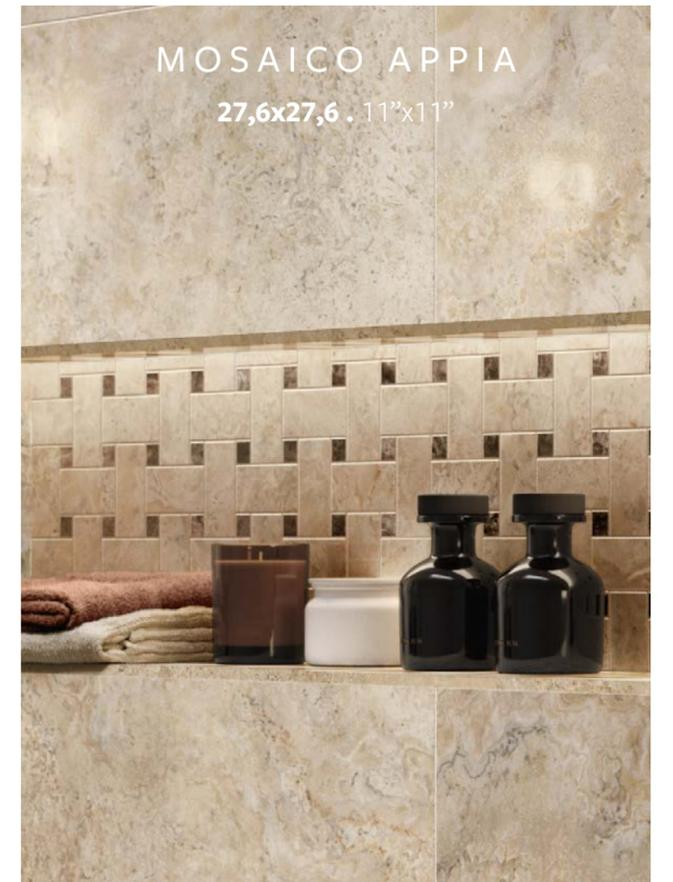

ROMA

Spessore . Thickness . Epaisseur . Stärke - 9 mm

Gres porcellanato colorato in massa. Full-body coloured porcelain stoneware. Grès cérame coloré dans la masse. In der Masse gefärbtes Feinsteinzeug.

TABELLA RIEPILOGATIVA

Summary table
Tableau récapitulatif
Zusammenfassende Tabelle

															
			60x120 24"x48"	30x60 12"x24"	10x30 4"x12"	Mosaico (5x5) 30x30 12"x12"	Mosaico Appia 27,6x27,6 11"x11"	Mosaico Esagona 28x29 11"x11 1/2"	Mosaico Emilia 30x30 12"x12"	*** Copriscigolo triangolare 1,4x120 1/2"x48"	Ang. Copriscigolo triang. 1,4x1,4 1/2"x 1/2"	Battiscopa 6,3x120 2 1/2"x48"	* Gradino a C 33x120x3,2h 13"x48"x1 1/4" h	* Ang. Gradino a C - SX 33x120x3,2h 13"x48"x1 1/4" h	* Ang. Gradino a C - DX 33x120x3,2h 13"x48"x1 1/4" h
SPESSORE - THICKNESS - EPAISSEUR - STÄRKE			9 mm	9 mm	9 mm	9 mm	9 mm	9 mm	9 mm	9 mm	9 mm	9 mm	9 mm	9 mm	9 mm
	ARGOS	◇ Velvet Ret.	132002	132062	132082	132302	132322	132342	132362	132402	132422	132102	132202	132234	132222
	COLONIA	◇ Velvet Ret.	132004	132064	132084	132304	132324	132344	132364	132404	132424	132104	132204	132238	132224
	EFESO	◇ Velvet Ret.	132008	132068	132088	132308	132328	132348	132368	132408	132428	132108	132208	132240	132228
	TOLOSA	◇ Velvet Ret.	132010	132070	132090	132310	132330	132350	132370	132410	132430	132110	132210	132242	132230
	FLORENTIA	◇ Velvet Ret.	132012	132072	132092	132312	132332	132352	132372	132412	132432	132112	132212	132244	132232
IMBALLI - PACKAGING EMBALLAGE - VERPACKUNG															
			Pallet	Pallet	Pallet	Pallet	Pallet	Pallet	Pallet			Pallet	Pallet	Pallet	Pallet
			80x120	80x120	80x120	80x120	80x120	80x120	80x120			80x120	80x120	80x120	80x120
N°															
m²															
** Kg															
 x			2	6	20	11	11	11	6	6		9	2	1	1
m² x			1,44	1,08	0,6	0,99	0,83	0,89	0,54						
Kg x			29	22	12	19,5	16,5	17,5	10,7	1,8		14,2	21	10,5	10,5
 x			30	40	72										
m² x			43,2	43,2	43,2										
** Kg x			890	900	884										
h x			75	75	73										
Imballo (Tara) - Packaging (Tare)			(20)	(20)	(20)	(20)	(20)	(20)	(20)			(20)	(20)	(20)	(20)

I pesi riportati in tabella sono indicativi e potrebbero essere soggetti a leggere variazioni.
The weights stated in the chart may undergo slight changes for production reasons.
Les poids indiqués dans le tableau peuvent subir de légères variations pour des raisons de production.
Die in der Tabelle angegebenen Gewichte können aus Produktionsgründen geringfügigen Abweichungen unterliegen.

Non si garantisce l'abbinabilità tra fondi di spessori diversi e tra fondo e pezzo speciale.
It is not guaranteed that background tiles with different thicknesses can be used together, nor is it guaranteed for background tiles and trims.
Nous ne garantissons pas la possibilité de combiner des carrelages de sol de différentes épaisseurs et un carrelage de sol avec une pièce spéciale.
Die Kombinierbarkeit von Fliesen unterschiedlicher Stärke sowie zwischen Fliese und Formteil kann nicht garantiert werden.

* A disposizione solo su richiesta. Tempi di consegna 30 gg.
Available upon request only. Delivery terms: 30 days.
Disponibile seulement sur requête. Délais de livraison: 30 jours.
Verfügbar auf Anfrage. Lieferzeit: 30 Tage.

** Il peso è comprensivo dell'imballo.
The total weight includes the packaging.
Le poids comprend aussi l'emballage.
Das Gesamtgewicht enthält auch die Verpackung.

*** Vendita a scatola completa.
Full box sale.
Vente à la boîte complète.
Volle Kartons.

◇ Velvet rettificato.
Velvet rectified.
Velvet rectifié.
Velvet rektifiziert.

LILAC

LILAC si ispira fin dal nome a un marmo naturale di origine orientale. Una varietà pregiata, che nel punto di virata dal fondo bianco alle vene nere, nitide e pronunciate, sprigiona, a volte una tenue sfumatura violetta. Questa particolarità unica viene restituita fedelmente da grafiche che evocano l'idea di un paesaggio emozionale dai tratti incantati e sospesi nel tempo. Disponibile in un'ampia gamma di grandi e medi formati, **LILAC** è l'ideale per realizzare pavimenti e rivestimenti e le più svariate e innovative applicazioni, da iconiche creazioni di interior design, come tavoli e lavabi, a eleganti facciate se usato come parete ventilata. **LILAC** è una lastra ceramica di ultima generazione; l'eccezionale lucentezza della superficie è il frutto dell'utilizzo in fase di produzione di speciali graniglie.

Starting with its name, **LILAC** pays homage to a natural oriental marble; a prestigious variety, whose dramatic black veining against a white background sometimes creates a pale violet shade. This completely unique feature is faithfully reproduced in the patterns of this series, which conjures up images of enchanted settings, suspended in time. Available in a wide range of large and medium sizes, **LILAC** is ideal to realize floors and walls and for the creation of the most varied and innovative applications, from iconic interior design creations, such as tables and bathroom basin tops, to stylish cladding for curtain walls. **LILAC** is a state-of-the-art ceramic slab; its extra-bright surface is obtained by using special granules during the manufacturing process.

Le nom **LILAC** s'inspire d'un marbre naturel d'origine orientale, une variété fine, où une légère nuance violette est libérée au niveau du point de virage du fond blanc aux veines noires, nettes et prononcées. Cette particularité unique est fidèlement rendue par les graphismes qui évoquent l'idée d'un paysage émotionnel aux traits enchantés et figés dans le temps. Disponible dans une large gamme de grands et moyens formats, **LILAC** est parfaite pour réaliser le revêtement des sol et des murs et les applications les plus variées et innovantes, des créations emblématiques de la décoration d'intérieur, telles que les tables et les lavabos, aux élégantes façades où elle est utilisée pour créer un mur ventilé. **LILAC** est une dalle céramique de dernière génération : l'effet extra-brillant de la surface a été obtenu grâce à l'utilisation des grenailles spéciales lors de la production.

LILAC ist vom Namen eines natürlichen Marmors orientalischen Ursprungs inspiriert. Eine edle Sorte, die am Wendepunkt vom weißen Hintergrund zu den klaren und ausgeprägten schwarzen Aderungen einen zarten violetten Farbton freisetzt. Diese einzigartige Besonderheit wird originalgetreu durch Grafiken reproduziert, die die Idee einer emotionalen Landschaft mit verzauberten, in der Zeit festgehaltenen Zügen hervorrufen. **LILAC** ist in einer breiten Palette großer und mittlerer Formate erhältlich und eignet sich hervorragend für die vielfältigsten und innovativsten Anwendungen, von ikonischen Kreationen für die Inneneinrichtung, wie Tischen und Waschbecken bis hin zu eleganten Fassaden als hinterlüftete Wand.

LILAC ist eine hochmoderne großartige Keramikplatte, die den extra hellen Oberflächeneffekt dank der im Jahr 2020 entwickelten Produktionstechnologie erzielt hat.

100% Made in Italy

PAVIMENTO E RIVESTIMENTO - WALL AND FLOOR:
LILAC 120x280 Nat. Ret / Collection FULL COLOURS MIDNIGHT 120x280 Nat. Ret.
SCALA - STAIRS:
Copriscopolo triangolare LILAC 0,8x120 Nat. Ret.
LAVABI - WASHBASINS:
LILAC Nat. Ret - Collection FULL COLOURS MIDNIGHT Nat. Ret.



PAVIMENTO E RIVESTIMENTO, WALL AND FLOOR
LILAC 120x280 Nat. Ret. - COPRISPIGOLO LILAC 0,8x120 - FULL COLOURS MIDNIGHT 120x280 Nat. Ret.
LAVABI - WASHBASINS
LILAC Nat. Ret. - FULL COLOURS MIDNIGHT Nat. Ret.



Spessore . Thickness . Epaisseur . Stärke - 6 mm

Lastre in gres porcellanato pressate a secco. Dry-pressed porcelain stoneware slabs. Dalles en grès cérame pressées à sec. Trocken gepresste Platten aus Feinsteinzeug.

Spessore . Thickness . Epaisseur . Stärke - 9 mm

Gres porcellanato colorato in massa. Full-body coloured porcelain stoneware. Grès cérame coloré dans la masse. In der Masse gefärbtes Feinsteinzeug.

GRANDI VARIETÀ DI GRAFICHE

Wide variety of graphics / Grande variété des graphismes / Große Vielfalt der Graphiken



Il numero delle grafiche può variare rispetto a quanto riportato e può essere differente tra i vari formati e/o colori.
The number of the patterns may differ from that shown herewith and may also vary depending on the selected size and/or colour.
Le nombre de graphismes peut varier par rapport à ce qui est reporté et il peut varier suivant les différents formats et/ou couleurs.
Die Anzahl der Grafiken kann von den Angaben abweichen und zwischen den verschiedenen Formaten und/oder Farben unterschiedlich sein.

TABELLA RIEPILOGATIVA

Summary table
Tableau récapitulatif
Zusammenfassenden Tabelle

		160x320 63"x126"	120x280 48"x110"	120x120 48"x48"	80x80 31 1/2"x31 1/2"	60x120 24"x48"	Mosaico (5x5) 30x30 12"x12"	** Coprispigo triangolare 0,8x120 1/4"x48"	1,4x120 1/2"x48"	Ang. Coprispigo triang. 0,8x0,8 1/4"x1/4"	1,4x1,4 1/2"x1/2"	Battiscopa 6,3x120 2 1/2"x48"	* Gradino a C 33x120x3,2h 13"x48"x1 1/4"h	* Ang. Gradino a C-DX 33x120x3,2h 13"x48"x1 1/4"h	* Ang. Gradino a C-SX 33x120x3,2h 13"x48"x1 1/4"h
SPESSORE - THICKNESS - EPAISSEUR - STÄRKE		6 mm	6 mm	6 mm	6 mm	▼ 9 mm	▼ 9 mm	6 mm	▼ 9 mm	6 mm	▼ 9 mm	▼ 9 mm	▼ 9 mm	▼ 9 mm	▼ 9 mm
	□ Nat. Ret.	107011	107021	107030	107036	107041	107080	107165	107175	107166	107176	107100	107150	107155	107160
	○ Lucidato Ret.	107010	107020	107031	107035	107040	107081	107170	107180	107171	107181	107101	107151	107156	107161
MQ x pezzo - Sqm x pcs		5,12	3,36												
Kg x pezzo - Kg x pcs		74,1	48,6												
IMBALLI - PACKAGING EMBALLAGE - VERPACKUNG															
		Cassa Crate 175x344x30h	Cassa Crate 145x292x34h	Pallet speciale Special pallet 123x144	Pallet 80x120	Pallet 80x120	Pallet 80x120			Pallet 80x120	Pallet 80x120	Pallet 80x120	Pallet 80x120	Pallet 80x120	Pallet 80x120
N°		14	20												
m²		71,68	67,2												
** Kg		1158	1062												
				2	3	2	11	6	6			9	2	1	1
				2,88	1,92	1,44	0,99								
				42	28,1	29	19,5	1,2	1,8			14,2	21	10,5	10,5
				24	40	30									
				69,12	76,8	43,2									
				1061	1144	890									
				65	95	75									
Imballo (Tara) - Packaging (Tare)		(120)	(90)	(53)	(20)	(20)									
		Cavalletto A-Frame 75x330x200h	Cavalletto A-Frame 75x290x160h												
N°		44	44												
m²		225,28	147,84												
** Kg		3431	2259												
Imballo (Tara) - Packaging (Tare)		(170)	(120)												

▼ Gli articoli nel nuovo spessore 9 mm saranno disponibili ad esaurimento dello stock esistente in spessore 10 mm.
9 mm items will be available once the current 10 mm stock we have has run out.
Les articles de 9 mm d'épaisseur seront disponibles dès que le stock en 10 mm sera terminé.
Die 9 mm Artikel werden verfügbar sein, sobald die 10 mm Lagerbestände abverkauft sind.

* A disposizione solo su richiesta. Tempi di consegna 30 gg.
Available upon request only. Delivery terms: 30 days.
Disponible seulement sur requête. Délais de livraison: 30 jours.
Verfügbar auf Anfrage. Lieferzeit: 30 Tage.

** Il peso è comprensivo dell'imballo.
The total weight includes the packaging.
Le poids comprend aussi l'emballage.
Das Gesamtgewicht enthält auch die Verpackung.

*** Vendita a scatola completa.
Full box sale.
Vente à la boîte complète.
Volle Kartons.

I pesi riportati in tabella sono indicativi e potrebbero essere soggetti a leggere variazioni.
The weights stated in the chart may undergo slight changes for production reasons.
Les poids indiqués dans le tableau peuvent subir de légères variations pour des raisons de production.
Die in der Tabelle angegebenen Gewichte können aus Produktionsgründen geringfügigen Abweichungen unterliegen.

Non si garantisce l'abbinabilità tra fondi di spessori diversi e tra fondo e pezzo speciale.
It is not guaranteed that background tiles with different thicknesses can be used together, nor is it guaranteed for background tiles and trims.
Nous ne garantissons pas la possibilité de combiner des carrelages de sol de différentes épaisseurs et un carrelage de sol avec une pièce spéciale.
Die Kombinierbarkeit von Fliesen unterschiedlicher Stärke sowie zwischen Fliese und Formteil kann nicht garantiert werden.

□ Naturale e rettificato.
Natural rectified.
Naturel et rectifié.
Natur Oberfläche und rektifiziert.

○ Lucidato e rettificato.
Glossy rectified.
Brillant et rectifié.
Glossy/Shiny und rektifiziert.

STATUARIO

Il marmo toscano più pregiato di sempre in un taglio ricercato, prediletto già dai Romani per realizzare eterne sculture e lussuose dimore ispira la omonima collezione **Tagina. STATUARIO** si lascia ammirare, fino al grande formato 160x320 cm sia lucido che naturale, per il fondo brillante attraversato da venature grigie fredde negli spessori 6 mm o 9 mm. **STATUARIO** è una lastra ceramica di ultima generazione: l'eccezionale lucentezza della superficie è il frutto dell'utilizzo in fase di produzione di speciali graniglie.

Paying homage to Tuscany's finest marble, **Tagina's STATUARIO** recreates the elegantly cut marble preferred by the Romans to fashion eternal sculptures and build sumptuous homes. Statuario's appeal can be appreciated in sizes ranging up to the oversize slabs measuring 160x320 cm (available in both glossy and natural finishes) featuring a brilliant background and cold grey veining, available in 6 mm or 9 mm thickness. **STATUARIO** is a state-of-the-art ceramic slab; its extra-bright surface is obtained by using special granules during the manufacturing process.

Le marbre toscan le plus précieux de tous les temps dans une coupe raffinée, déjà préférée par les Romains pour créer des sculptures éternelles et des demeures luxueuses, inspire la collection éponyme de **Tagina. STATUARIO** doit sa beauté jusqu'au grand format 160x320 cm, à la fois poli et naturel, au fond brillant traversé par des veines grises froides, dans les épaisseurs de 6 mm ou 9 mm. **STATUARIO** est une dalle céramique de dernière génération : l'effet extra-brillant de la surface a été obtenu grâce à l'utilisation des grenailles spéciales lors de la production.

Der kostbarste toskanische Marmor aller Zeiten in einem raffinierten Schnitt, der bereits von den Römern für die Erstellung ewiger Skulpturen und luxuriöser Wohnsitze bevorzugt wurde, inspiriert die gleichnamige Kollektion von **Tagina. STATUARIO** lässt sich bis zum Großformat 160x320 cm sowohl glänzend als auch natürlich aufgrund des herrlichen Untergrundes bewundern, der in den Stärken von 6 mm oder 9 mm von kalten grauen Aderungen durchzogen ist. **STATUARIO** ist eine hochmoderne großartige Keramikplatte, die den extra hellen Oberflächeneffekt dank der im Jahr 2020 entwickelten Produktionstechnologie erzielt hat.

100% Made in Italy



RIVESTIMENTO . WALL: STATUARIO 160x320 Lucidato Ret.
PAVIMENTO . FLOOR: STATUARIO 160x320 Lucidato Ret. / STATUARIO BOOKMATCH A-B 160x320 Lucidato Ret.



STATUARIO

Spessore . Thickness . Epaisseur . Stärke - **6 mm**

Lastre in gres porcellanato pressate a secco . Dry-pressed porcelain stoneware slabs . Dalles en grès cérame pressées à sec . Trocken gepresste Platten aus Feinsteinzeug.

GRANDI VARIETÀ DI GRAFICHE

Wide variety of graphics / Grande variété des graphismes / Große Vielfalt der Graphiken

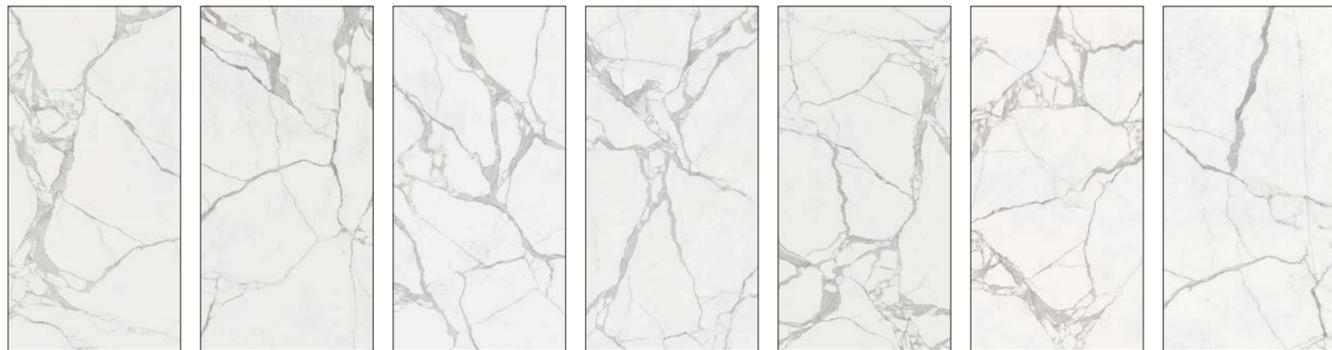

Ambienti unici e originali grazie ad una grande varietà di grafiche.
The greatly varying patterns featured result in unique and original interiors.
Des espaces uniques et originaux grâce à une grande variété de graphismes.
Einzigartige und originelle Räume dank einer großen Vielfalt von Grafiken.

Il numero delle grafiche può variare rispetto a quanto riportato e può essere differente tra i vari formati e/o colori.
The number of the patterns may differ from that shown herewith and may also vary depending on the selected size and/or colour.
Le nombre de graphismes peut varier par rapport à ce qui est reporté et il peut varier suivant les différents formats et/ou couleurs.
Die Anzahl der Grafiken kann von den Angaben abweichen und zwischen den verschiedenen Formaten und/oder Farben unterschiedlich sein.



STATUARIO 160x320 Lucidato Ret.

BOOKMATCH

Bookmatch A

160x320
63"x126"

Bookmatch B

160x320
63"x126"

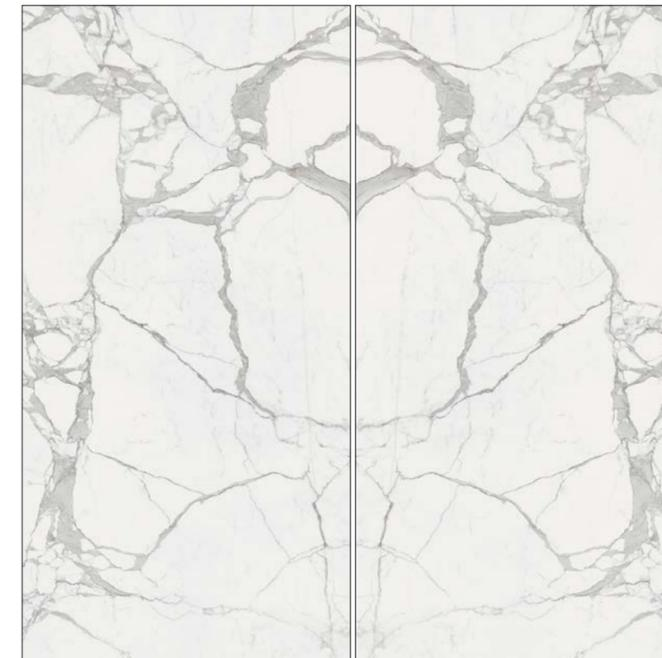

Bookmatch A

120x280
48"x110"

Bookmatch B

120x280
48"x110"

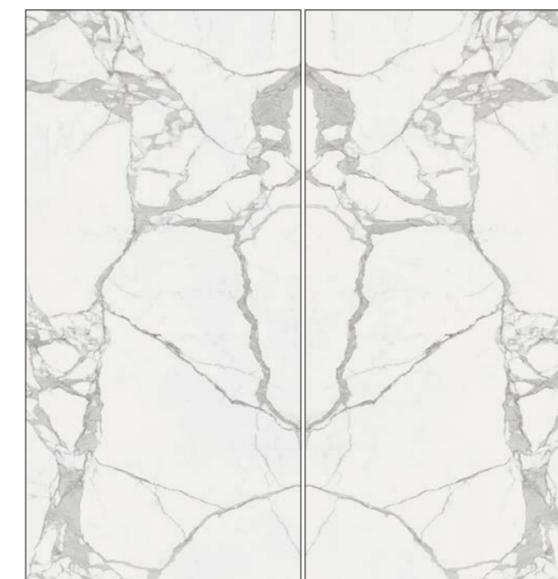

Negli articoli Bookmatch A e B, una discontinuità di grafica (delle vene) fino a 1,5 cm dal passaggio tra una lastra e l'altra, è da considerarsi normale ovvero una caratteristica del prodotto.
Any mismatch of up to 1.5 cm between the veining of our Bookmatch A and B slabs is to be regarded as normal as it is an intrinsic characteristic of the product.
Dans les articles Bookmatch A et B une discontinuité de graphisme (des veines) jusqu'à 1.5 cm du passage d'une dalle à l'autre doit être considérée normal ou bien une caractéristique du produit.
Bei Bookmatch A und B sind Brüche der Aderungen beim Übergang von einer Platte zur anderen als normal einzustufen. Aus diesem Grund sind Unterschiede bis zu 1,5 cm als Eigenschaft des Produkts zu betrachten.

STATUARIO

Spessore . Thickness . Epaisseur . Stärke - 6 mm

Lastre in gres porcellanato pressate a secco . Dry-pressed porcelain stoneware slabs . Dalles en grès cérame pressées à sec . Trocken gepresste Platten aus Feinsteinzeug.

Spessore . Thickness . Epaisseur . Stärke - 9 mm

Gres porcellanato colorato in massa . Full-body coloured porcelain stoneware . Grès cérame coloré dans la masse . In der Masse gefärbtes Feinsteinzeug.

TABELLA RIEPILOGATIVA

Summary table
Tableau récapitulatif
Zusammenfassende Tabelle

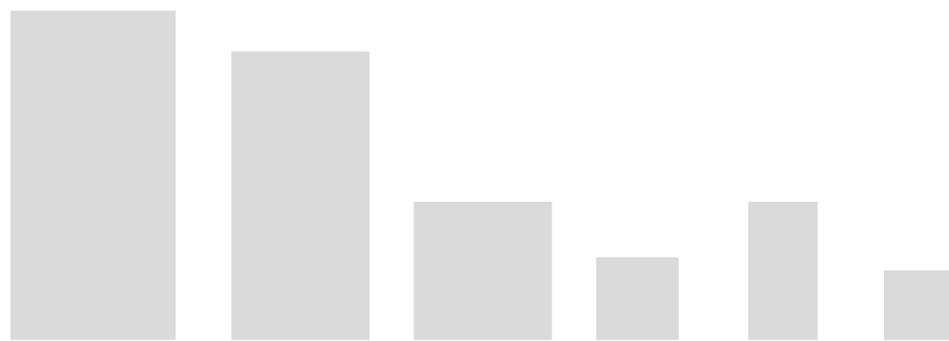

		160x320 63"x126"	120x280 48"x110"	120x120 48"x48"	80x80 31 1/2"x31 1/2"	60x120 24"x48"	60x60 24"x24"	Mosaico (5x5) 30x30 12"x12"	*** Coprispigo triangolare 0,8x120 1/4"x48"	1,4x120 1/2"x48"	Ang. Coprispigo triang. 0,8x0,8 1/4"x1/4"	1,4x1,4 1/2"x1/2"	Battiscopa 6,3x120 2 1/2"x48"	* Gradino a C 33x120x3,2h 13"x48"x1 1/4"h	* Ang. gradino a C - SX 33x120x3,2h 13"x48"x1 1/4"h	* Ang. gradino a C - DX 33x120x3,2h 13"x48"x1 1/4"h
SPESSORE - THICKNESS - EPAISSEUR - STÄRKE		6 mm	6 mm	6 mm	6 mm	▼ 9 mm	▼ 9 mm	▼ 9 mm	6 mm	▼ 9 mm	6 mm	▼ 9 mm	▼ 9 mm	▼ 9 mm	▼ 9 mm	▼ 9 mm
	□ Nat. Ret.	106011	106021	106031	106036	106041	106051	106091	106122	106125	106131	106134	106101	106115	106117	106116
	○ Lucidato. Ret.	106010	106020	106030	106035	106040	106050	106090	106121	106124	106132	106135	106100	106110	106112	106111
STATUARIO	○ Lucidato. Ret.	106012	106022													
STATUARIO BOOKMATCH A	○ Lucidato. Ret.	106013	106023													
STATUARIO BOOKMATCH B	○ Lucidato. Ret.															
MQ x pezzo - Sqm x pcs		5,12	3,36													
Kg x pezzo - Kg x pcs		74,1	48,6													
IMBALLI - PACKAGING EMBALLAGE - VERPACKUNG																
		Cassa Crate 175x344x30h	Cassa Crate 145x292x34h	Pallet speciale Special pallet 123x144	Pallet 80x120	Pallet 80x120	Pallet 80x120	Pallet 80x120					Pallet 80x120	Pallet 80x120	Pallet 80x120	Pallet 80x120
N°		14	20													
m²		71,68	67,2													
** Kg		1158	1062													
				2	3	2	3	11	6	6			9	2	1	1
m² x				2,88	1,92	1,44	1,08	0,99								
Kg x				42	28,1	29	22	19,5	1,2	1,8			14,2	21	10,5	10,5
m² x				24	40	30	40									
** Kg x				69,12	76,8	43,2	43,2									
h x				65	95	75	75									
Imballo (tara) - Packaging (tare)		(120)	(90)	(53)	(20)	(20)	(20)	(20)					(20)	(20)	(20)	(20)
		Cavalletto A-Frame 75x330x200h	Cavalletto A-Frame 75x290x160h													
N°		44	44													
m²		225,28	147,84													
** Kg		3431	2259													
Imballo (tara) - Packaging (tare)		(170)	(120)													

▼ Gli articoli nel nuovo spessore 9 mm saranno disponibili ad esaurimento dello stock esistente in spessore 10 mm.
9 mm items will be available once the current 10 mm stock we have has run out.
Les articles de 9 mm d'épaisseur seront disponibles dès que le stock en 10 mm sera terminé.
Die 9 mm Artikel werden verfügbar sein, sobald die 10 mm Lagerbestände abverkauft sind.

* A disposizione solo su richiesta. Tempi di consegna 30 gg.
Available upon request only. Delivery terms: 30 days.
Disponible seulement sur requête. Délais de livraison: 30 jours.
Verfügbar auf Anfrage. Lieferzeit: 30 Tage.

** Il peso è comprensivo dell'imballo.
The total weight includes the packaging.
Le poids comprend aussi l'emballage.
Das Gesamtgewicht enthält auch die Verpackung.

*** Vendita a scatola completa.
Full box sale.
Vente à la boîte complète.
Volle Kartons.

I pesi riportati in tabella sono indicativi e potrebbero essere soggetti a leggere variazioni.
The weights stated in the chart may undergo slight changes for production reasons.
Les poids indiqués dans le tableau peuvent subir de légères variations pour des raisons de production.
Die in der Tabelle angegebenen Gewichte können aus Produktionsgründen geringfügigen Abweichungen unterliegen.

Non si garantisce l'abbinabilità tra fondi di spessori diversi e tra fondo e pezzo speciale.
It is not guaranteed that background tiles with different thicknesses can be used together, nor is it guaranteed for background tiles and trims.
Nous ne garantissons pas la possibilité de combiner des carrelages de sol de différentes épaisseurs et un carrelage de sol avec une pièce spéciale.
Die Kombinierbarkeit von Fliesen unterschiedlicher Stärke sowie zwischen Fliese und Formteil kann nicht garantiert werden.

□ Naturale e rettificato.
Natural rectified.
Naturel et rectifié.
Natur Oberfläche und rektifiziert.

○ Lucidato e rettificato.
Glossy rectified.
Brillant et rectifié.
Glossy/Shiny und rektifiziert.

CALACATTA GOLD

CALACATTA GOLD by **TAGINA** è una collezione in gres porcellanato che si ispira al prezioso marmo italiano cavato in Toscana, nelle Alpi Apuane. L'aspetto scenografico delle sue preziose venature giallo-oro, esaltate da un fondo bianco-paglierino, la rendono una collezione ideale per arredare ambientazioni lussuose, anche con oggettistica minimale, nonché moderne soprattutto se abbinata ad altri materiali quali effetti legno e metallo.

CALACATTA GOLD by **TAGINA** is a porcelain stoneware collection inspired by the precious Italian marble quarried in Tuscany, in the Apuan Alps. The striking aspect of its refined yellow-gold veins, highlighted by a white-straw background, make it an ideal collection for furnishing luxurious environments, even with minimalist objects, as well as modern ones especially when combined with other materials such as wood and metal effects.

CALACATTA GOLD de **TAGINA** est une collection en grès cérame inspirée du précieux marbre italien extrait en Toscane, dans les Alpes Apuanes. L'aspect scénographique de ses précieuses veines jaune-or, rehaussées d'un fond de paille blanche, en font une collection idéale pour meubler des espaces haut de gamme, minimalistes et modernes, surtout si elles sont associées à d'autres matériaux tels que le bois et le métal.

CALACATTA GOLD von **TAGINA** ist eine Feinsteinzeugkollektion, die von dem wertvollen italienischen Marmor inspiriert ist, der in den Apuanischen Alpen in der Toskana abgebaut wird. Das spektakuläre Erscheinungsbild der kostbaren gelb-goldenen Adern, das durch den strohweißen Hintergrund noch verstärkt wird, macht sie zu einer idealen Kollektion für die Einrichtung luxuriöser Räume, auch mit minimalistischen Objekten, sowie für moderne Räume, insbesondere in Kombination mit anderen Materialien wie Holz und Metalleffekten.

100% Made in Italy



RIVESTIMENTO . WALL:
CALACATTA GOLD 120x280 Nat Ret.

PAVIMENTO . FLOOR:
CALACATTA GOLD 120x120 Nat Ret.

TOP E LAVABI . TOP AND WASHBASINS:
CALACATTA GOLD 6 mm Nat Ret.



MARBLE & ONYX COLLECTION CALACATTA GOLD



PAVIMENTO . FLOOR:
CALACATTA GOLD 120x120 Nat Ret.
TOP E LAVABI . TOP AND WASHBASINS:
CALACATTA GOLD 6 mm Nat Ret.

Robert Cooper

The break
with traditional
naturalism.

01

This movement started in Paris towards the end of the nineteenth century when interesting things began to happen to painting. Artists were beginning to work in new ways.

Este movimiento se inició en París a finales del siglo cuando empezaron a suceder cosas interesantes en la pintura. Los artistas empezaban a trabajar en formas nuevas.

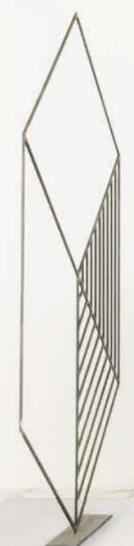

Modern
Art
Gallery

AMSTERDAM

History and Characteristics
This movement with traditional
not only painting but also sculpture
became a new way of seeing the world
and the century.

Spessore . Thickness . Epaisseur . Stärke - 6 mm

Lastre in gres porcellanato pressate a secco. Dry-pressed porcelain stoneware slabs. Dalles en grès cérame pressées à sec. Trocken gepresste Platten aus Feinsteinzeug.

Spessore . Thickness . Epaisseur . Stärke - 9 mm

Gres porcellanato colorato in massa. Full-body coloured porcelain stoneware. Grès cérame coloré dans la masse. In der Masse gefärbtes Feinsteinzeug.

TABELLA RIEPILOGATIVA

Summary table
Tableau récapitulatif
Zusammenfassende Tabelle

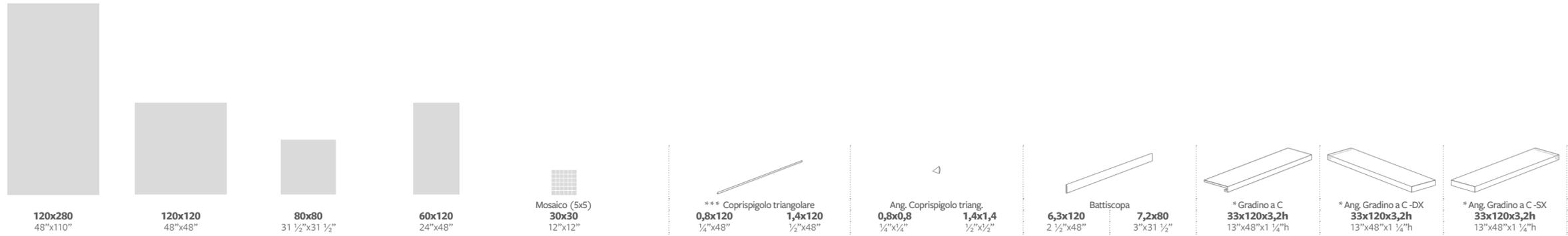

SPESSORE - THICKNESS - EPAISSEUR - STÄRKE		6 mm	9 mm	9 mm	9 mm	9 mm	6 mm	9 mm	6 mm	9 mm	9 mm	9 mm	9 mm	9 mm	
	<input type="checkbox"/> Nat. Ret.	133010	133020	133030	133040	133300	133400	133401	133402	133403	133100	133105	133200	133202	133204
	<input type="checkbox"/> Lucidato Ret.	133011	133021	133031	133041	133301	133404	133405	133406	133407	133101	133106	133201	133203	133205
MQ x pezzo - Sqm x pcs		3,36													
Kg x pezzo - Kg x pcs		48,6													
IMBALLI - PACKAGING EMBALLAGE - VERPACKUNG															
		Cassa Crate 145x292x34h	Pallet speciale Special pallet 123x144	Pallet 80x120	Pallet 80x120	Pallet 80x120					Pallet 80x120	Pallet 80x120	Pallet 80x120	Pallet 80x120	Pallet 80x120
N°		20													
m²		67,2													
** Kg		1062													
			2	2	2	11	6	6			9	8	2	1	1
m² x			2,88	1,28	1,44										
Kg x			58	26	29	19,5	1,2	1,8			14,9	8,5	21	10,5	10,5
			18	40	30										
m² x			51,84	51,2	43,2										
** Kg x			1097	1060	890										
			65	95	75										
h x															
Imballo (Tara) - Packaging (Tare)		(90)	(53)	(20)	(20)	(20)					(20)	(20)	(20)	(20)	(20)
		Cavalletto A-Frame 75x290x160h													
N°		44													
m²		147,84													
** Kg		2344													
Imballo (Tara) - Packaging (Tare)		(205)													

I pesi riportati in tabella sono indicativi e potrebbero essere soggetti a leggere variazioni.
The weights stated in the chart may undergo slight changes for production reasons.
Les poids indiqués dans le tableau peuvent subir de légères variations pour des raisons de production.
Die in der Tabelle angegebenen Gewichte können aus Produktionsgründen geringfügigen Abweichungen unterliegen.

Non si garantisce l'abbinabilità tra fondi di spessori diversi e tra fondo e pezzo speciale.
It is not guaranteed that background tiles with different thicknesses can be used together, nor is it guaranteed for background tiles and trims.
Nous ne garantissons pas la possibilité de combiner des carrelages de sol de différentes épaisseurs et un carrelage de sol avec une pièce spéciale.
Die Kombinierbarkeit von Fliesen unterschiedlicher Stärke sowie zwischen Fliese und Formteil kann nicht garantiert werden.

* A disposizione solo su richiesta. Tempi di consegna 30 gg.
Available upon request only. Delivery terms: 30 days.
Disponible seulement sur requête. Délais de livraison: 30 jours.
Verfügbar auf Anfrage. Lieferzeit: 30 Tage.

** Il peso è comprensivo dell'imballo.
The total weight includes the packaging.
Le poids comprend aussi l'emballage.
Das Gesamtgewicht enthält auch die Verpackung.

*** Vendita a scatola completa.
Full box sale.
Vente à la boîte complète.
Volle Kartons.

Naturale e rettificato.
Natural rectified.
Naturel et rectifié.
Natur Oberfläche und rektifiziert.

Lucidato e rettificato.
Glossy rectified.
Brillant et rectifié.
Glossy/Shiny und rektifiziert.

SEGESTA

‘Così rimani, indelebile nel cuore e nella mente, curioso ed amabile capriccio di madre natura’. Così il poeta Nino Testa descriveva i panorami della Sicilia, l'incantevole luogo da cui si estrae il nobile marmo bianco che ha ispirato **SEGESTA**. Una collezione che non solo ha fatto propria questa emozione ma ha saputo anche catturare, nei suoi 3 colori, l'essenza stessa dell'isola: il sole, nel colore Caramel, il mare, nel colore Blu e la sua lussureggiante vegetazione, nel colore Verde. Una collezione aristocratica e moderna, elegante e di assoluto design 100% Made in Italy.

‘So you remain, indelible in heart and mind, curious and lovely whim of mother nature’. This is how poet Nino Testa described the landscape of Sicily, the enchanting place that gives us the noble white marble that inspired **SEGESTA**. A collection that not only managed to capture this sentiment, but also the very essence of the island with its 3 colours: the sun, with the Caramel colour, the sea, with the Blue colour, and its luxuriant vegetation, with the Green colour. An aristocratic and modern collection, elegant and absolutely 100% Made in Italy.

‘C'est ainsi que vous restez, indélébile dans le cœur et l'esprit, curieux et aimable caprice de mère nature’. C'est ainsi que le poète Nino Testa a décrit les paysages de la Sicile, lieu enchanteur d'où est extrait le noble marbre blanc qui a inspiré **SEGESTA**. Une collection qui a non seulement embrassé cette émotion, mais qui a également capturé, dans ses 3 couleurs, l'essence même de l'île : le soleil, couleur caramel, la mer, en bleu, et sa végétation luxuriante, en vert. Une collection aristocratique et moderne, élégante et d'un design absolu 100 % Made in Italy.

‘So bleibst du, unauslöschlich in Herz und Geist, eine eigenwillige und liebenswerte Laune von Mutter Natur’. So beschrieb der Dichter Nino Testa die Landschaften Siziliens, der bezaubernden Region, in der der edle weiße Marmor gewonnen wird, der **SEGESTA** inspiriert hat. Eine Kollektion, die nicht nur diese Emotion aufgreift, sondern auch das Wesen der Insel in ihren drei Farben widerspiegelt: die Sonne in Caramel, das Meer in Blau und die üppige Vegetation in Grün. Eine aristokratische und moderne Kollektion, elegant und zu 100% Made in Italy.

100% Made in Italy

RIVESTIMENTO . WALL: CAMEL 120x280 Lucidato Ret. / COPRISPIGOLO TRIANGOLARE CAMEL 0,8x120 Lucidato Ret.
PAVIMENTO . FLOOR: CAMEL 120x120 Lucidato Ret. / LAVABI . WASHBASINS: CAMEL 6 mm Lucidato Ret.
VASCA . BATHTUB: CAMEL 6 mm Lucidato Ret.



RIVESTIMENTO - WALL: CAMEL 120x280 Lucidato Ret. / COPRISPIGOLO TRIANGOLARE CAMEL 0,8x120 Lucidato Ret.
PAVIMENTO - FLOOR: CAMEL 120x120 Lucidato Ret. / LAVABI - WASHBASINS: CAMEL 6 mm Lucidato Ret.
VASCIA - BATHTUB: CAMEL 6 mm Lucidato Ret.





RIVESTIMENTO . WALL: VERDE 120x280 Lucidato Ret. / Coprispigoletto triangolare VERDE 0,8x120 Lucidato Ret.
PAVIMENTO . FLOOR: VERDE 120x120 Lucidato Ret



RIVESTIMENTO - WALL: BLU 160x320 Lucidato Ret.
PAVIMENTO - FLOOR: BLU 60x60 Nat. Ret. - 60x120 Nat. Ret.



RIVESTIMENTO . WALL: BLU 160x320 Lucidato Ret.
PAVIMENTO . FLOOR: BLU 60x60 Nat. Ret. - 60x120 Nat. Ret.





RIVESTIMENTO . WALL: BLU 60x120 . 30x60 . 7,5x30 Nat. Ret.
PAVIMENTO . FLOOR: BLU 60x60 Nat. Ret.

SEGESTA, nello spessore 9 mm, sia nella finitura “naturale” che “lucidata”, riproduce fedelmente gli effetti estetici e tattili del marmo a cui si ispira. Grazie ad innovative tecnologie di decorazione della superficie, i leggeri avvallamenti che seguono le venature del marmo naturale vengono riprodotti in modo fedele e casuale. Ne risulta un’esperienza tattile sorprendente e un aspetto della superficie estremamente naturale quanto affascinante.

SEGESTA, in thickness 9 mm and “natural” and “polished” finishes, faithfully reproduces the aesthetic and tactile effects of the marble that it is inspired after. Thanks to innovative surface decoration technologies, the slight dips that follow the veins of natural marble are faithfully and randomly replicated. The result is a stunning tactile experience and an extremely natural and enchanting surface appearance.

SEGESTA, dans l’épaisseur de 9 mm, avec la finition “naturelle” et “brillante” reproduit fidèlement les effets esthétiques et tactiles du marbre dont il s’inspire. Grâce à des technologies innovantes de décoration de la surface, les légers creux qui suivent les veines du marbre naturel sont reproduits de manière fidèle et au hasard. Le résultat est une expérience tactile surprenante et un aspect de la surface extrêmement aussi naturel que fascinant.

SEGESTA in 9 mm, gibt sowohl in der Ausführung „Natur“ als auch Glossy/Shiny die ästhetischen und taktilen Effekte des Marmors, von dem es inspiriert ist, authentisch wieder. Dank der innovativen Technologien für die Oberflächengestaltung werden die leichten Vertiefungen, die der Maserung des natürlichen Marmors entsprechen, naturgetreu und gemischt wiedergegeben. Das Ergebnis ist ein überraschendes haptisches Erlebnis und ein äußerst natürliches und faszinierendes Oberflächenbild.



Naturale
Natural
Naturel
Natur
BLU



Lucidato
Glossy
Brillant
Glossy/Shiny
CARMEL

FORMATI

Sizes / Formats / Formate

6 mm . 160x320 - 63"x126" / 120x280 - 48"x110" / 120x120 - 48"x48"
9 mm . 60x120 - 24"x48" / 60x60 - 24"x24" / 30x60 - 12"x24" / 7,5x30 - 3"x12"

GRANDI VARIETÀ DI GRAFICHE

Wide variety of graphics / Grande variété des graphismes / Große Vielfalt der Graphiken



Ambienti unici e originali grazie ad una grande varietà di grafiche.
 The greatly varying patterns featured result in unique and original interiors.
 Des espaces uniques et originaux grâce à une grande variété de graphismes.
 Einzigartige und originelle Räume dank einer großen Vielfalt von Grafiken.

Il numero delle grafiche può variare rispetto a quanto riportato e può essere differente tra i vari formati e/o colori.
 The number of the patterns may differ from that shown herewith and may also vary depending on the selected size and/or colour.
 Le nombre de graphismes peut varier par rapport à ce qui est reporté et il peut varier suivant les différents formats et/ou couleurs.
 Die Anzahl der Grafiken kann von den Angaben abweichen und zwischen den verschiedenen Formaten und/oder Farben unterschiedlich sein.

COLORI

Colours / Couleurs / Farben



BLU



VERDE



CAMEL



CAMEL 120x280 Lucidato Ret. - COPRISPIGOLO TRIANGOLARE SEGESTA CAMEL 0,8x120 Lucidato Ret.

Spessore . Thickness . Epaisseur . Stärke - 6 mm

Lastre in gres porcellanato pressate a secco . Dry-pressed porcelain stoneware slabs . Dalles en grès cérame pressées à sec . Trocken gepresste Platten aus Feinsteinzeug.

Spessore . Thickness . Epaisseur . Stärke - 9 mm

Gres porcellanato colorato in massa . Full-body coloured porcelain stoneware . Grès cérame coloré dans la masse . In der Masse gefärbtes Feinsteinzeug.

TABELLA RIEPILOGATIVA

Summary table
Tableau récapitulatif
Zusammenfassende Tabelle

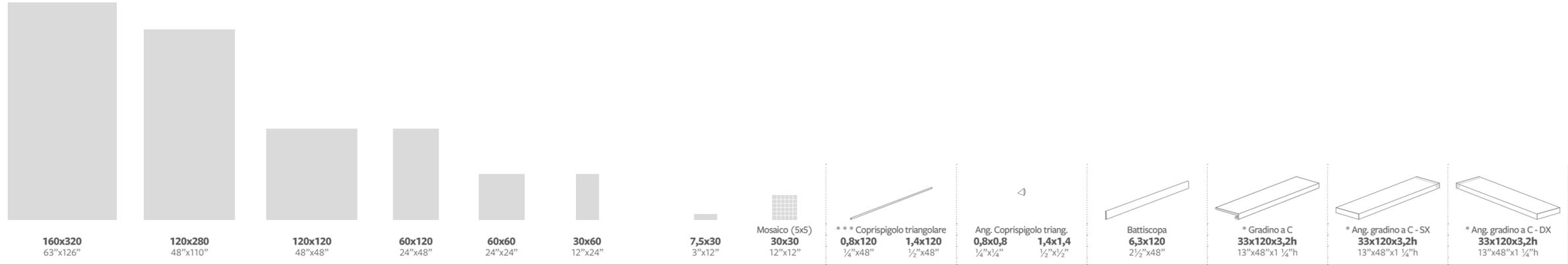

SPESORE - THICKNESS - EPAISSEUR - STÄRKE		6 mm	6 mm	6 mm	▼ 9 mm	▼ 9 mm	▼ 9 mm	▼ 9 mm	▼ 9 mm	▼ 9 mm	6 mm	▼ 9 mm	6 mm	▼ 9 mm	▼ 9 mm	▼ 9 mm	▼ 9 mm	
BLU	□ Nat. Ret.	-	-	-	127040	127050	127060		127070	-	-	127410	-	127430	127101	127201	127211	127221
	○ Lucidato Ret.	127010	127020	127030	127041	127051	127061		127071	127301	127401	127411	127421	127431	127102	127202	127212	127222
VERDE	□ Nat. Ret.	-	-	-	127042	127052	127062		127072	-	-	127412	-	127432	127103	127203	127213	127223
	○ Lucidato Ret.	127012	127022	127032	127043	127053	127063		127073	127303	127403	127413	127423	127433	127104	127204	127214	127224
CARAMEL	□ Nat. Ret.	-	-	-	127044	127054	127064		127074	-	-	127414	-	127434	127105	127205	127215	127225
	○ Lucidato Ret.	127014	127024	127034	127045	127055	127065		127075	127305	127405	127415	127425	127435	127106	127206	127216	127226
MQ x pezzo - Sqm x pcs		5,12	3,36															
Kg x pezzo - Kg x pcs		74,1	48,6															
IMBALLI - PACKAGING EMBALLAGE - VERPACKUNG																		
		Cassa Crate 175x344x30h	Cassa Crate 145x292x34h	Pallet speciale Special pallet 123x144	Pallet 80x120	Pallet 80x120	Pallet 80x120		Pallet 80x120	Pallet 80x120				Pallet 80x180	Pallet 80x180	Pallet 80x180	Pallet 80x180	Pallet 80x180
N°		14	20						25	11	6	6		9	2	1	1	
m²		71,68	67,2						0,56	0,99								
** Kg		1158	1062						12,5	19,5	1,2	1,8		14,2	21	10,5	10,5	
				2	2	3	6											
m² x				2,88	1,44	1,08	1,08											
Kg x				42	29	22	22											
				24	30	40	40											
m² x				69,12	43,2	43,2	43,2											
** Kg x				1061	890	900	900											
h x				65	75	75	75											
Imballo (tara) - Packaging (tare)		(120)	(90)	(53)	(20)	(20)	(20)		(20)	(20)				(20)	(20)	(20)	(20)	(20)
		Cavalletto A-Frame 75x330x200h	Cavalletto A-Frame 75x290x160h															
N°		44	44															
m²		225,28	147,84															
** Kg		3431	2259															
Imballo (tara) - Packaging (tare)		(170)	(120)															

▼ Gli articoli nel nuovo spessore 9 mm saranno disponibili ad esaurimento dello stock esistente in spessore 10 mm.
9 mm items will be available once the current 10 mm stock we have has run out.
Les articles de 9 mm d'épaisseur seront disponibles dès que le stock en 10 mm sera terminé.
Die 9 mm Artikel werden verfügbar sein, sobald die 10 mm Lagerbestände abverkauft sind.

* A disposizione solo su richiesta. Tempi di consegna 30 gg.
Available upon request only. Delivery terms: 30 days.
Disponible seulement sur requête. Délais de livraison: 30 jours.
Verfügbar auf Anfrage. Lieferzeit: 30 Tage.

** Il peso è comprensivo dell'imballo.
The total weight includes the packaging.
Le poids comprend aussi l'emballage.
Das Gesamtgewicht enthält auch die Verpackung.

*** Vendita a scatola completa.
Full box sale.
Vente à la boîte complète.
Volle Kartons.

I pesi riportati in tabella sono indicativi e potrebbero essere soggetti a leggere variazioni.
The weights stated in the chart may undergo slight changes for production reasons.
Les poids indiqués dans le tableau peuvent subir de légères variations pour des raisons de production.
Die in der Tabelle angegebenen Gewichte können aus Produktionsgründen geringfügigen Abweichungen unterliegen.

Non si garantisce l'abbinabilità tra fondi di spessori diversi e tra fondo e pezzo speciale.
It is not guaranteed that background tiles with different thicknesses can be used together, nor is it guaranteed for background tiles and trims.
Nous ne garantissons pas la possibilité de combiner des carrelages de sol de différentes épaisseurs et un carrelage de sol avec une pièce spéciale.
Die Kombinierbarkeit von Fliesen unterschiedlicher Stärke sowie zwischen Fliese und Formteil kann nicht garantiert werden.

□ Naturale e rettificato.
Natural rectified.
Naturel et rectifié.
Natur Oberfläche und rektifiziert.

○ Lucidato e rettificato.
Glossy rectified.
Brillant et rectifié.
Glossy/Shiny und rektifiziert.

MARQUINA

MARQUINA NERO by **Tagina** si caratterizza per l'intenso color nero del fondo interrotto da irregolari venature diagonali di color grigio/bianche. Si ispira al marmo naturale da cui prende il nome e si distingue per l'elevato grado di gloss della superficie, una particolare brillantezza e profondità ottenuta mediante l'uso in produzione di graniglie di ultima generazione.

MARQUINA NERO by **Tagina** is characterised by the intense blackness of the background punctuated by irregular diagonal grey/white veins. It is inspired by the natural marble from which it takes its name and is distinguished by the high level of gloss of the surface, a particular brilliance and depth obtained through the use in production of latest generation grits.

MARQUINA NERO by **Tagina** se caractérise par la couleur noire intense du fond, interrompue par des marbrures diagonales de couleur grises/blanches. Il s'inspire du marbre naturel dont il prend le nom et se distingue par le degré élevé de gloss de la surface, une brillance et profondeur particulières obtenues à travers l'utilisation pour la production de graviers de dernière génération.

MARQUINA NERO von **Tagina** zeichnet sich durch die intensive schwarze Farbe des Fondes aus, die durch unregelmäßige grau/weiße diagonale Adern unterbrochen wird. Es ist inspiriert vom natürlichen Marmor und verdankt diesem seinen Namen. Es zeichnet sich durch einen hohen Oberflächenglanz, eine besondere Brillanz und Tiefe aus, die durch die Verwendung von Körnungen der neuesten Generation erreicht werden.

100% Made in Italy

FORMATI

Sizes / Formats / Formate

6 mm . 160x320 - 63"x126" / 120x280 - 48"x110" / 120x120 - 48"x48" / 80x80 - 31 1/2"x31 1/2"
 9 mm . 60x120 - 24"x48"

GRANDI VARIETÀ DI GRAFICHE

Wide variety of graphics / Grande variété des graphismes / Große Vielfalt der Graphiken

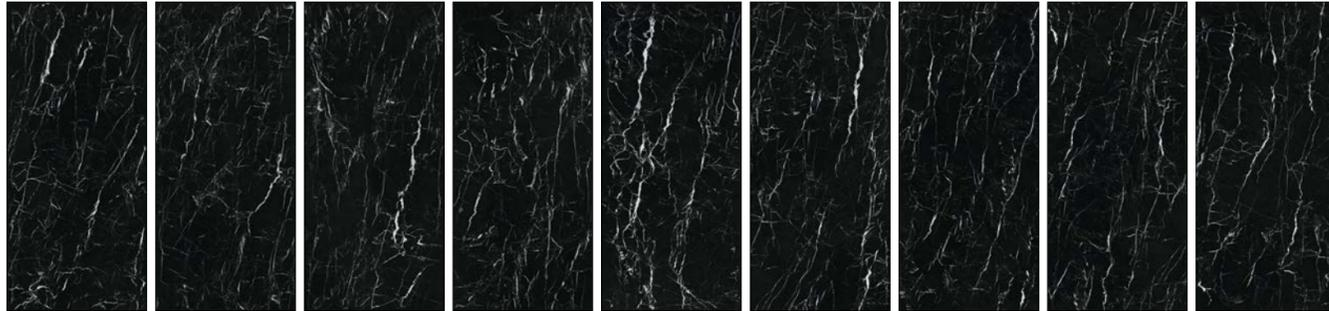

Ambienti unici e originali grazie ad una grande varietà di grafiche.
 The greatly varying patterns featured result in unique and original interiors.
 Des espaces uniques et originaux grâce à une grande variété de graphismes.
 Einzigartige und originelle Räume dank einer großen Vielfalt von Grafiken.

Il numero delle grafiche può variare rispetto a quanto riportato e può essere differente tra i vari formati e/o colori.
 The number of the patterns may differ from that shown herewith and may also vary depending on the selected size and/or colour.
 Le nombre de graphismes peut varier par rapport à ce qui est reporté et il peut varier suivant les différents formats et/ou couleurs.
 Die Anzahl der Grafiken kann von den Angaben abweichen und zwischen den verschiedenen Formaten und/oder Farben unterschiedlich sein.

COLORI

Colours / Couleurs / Farben

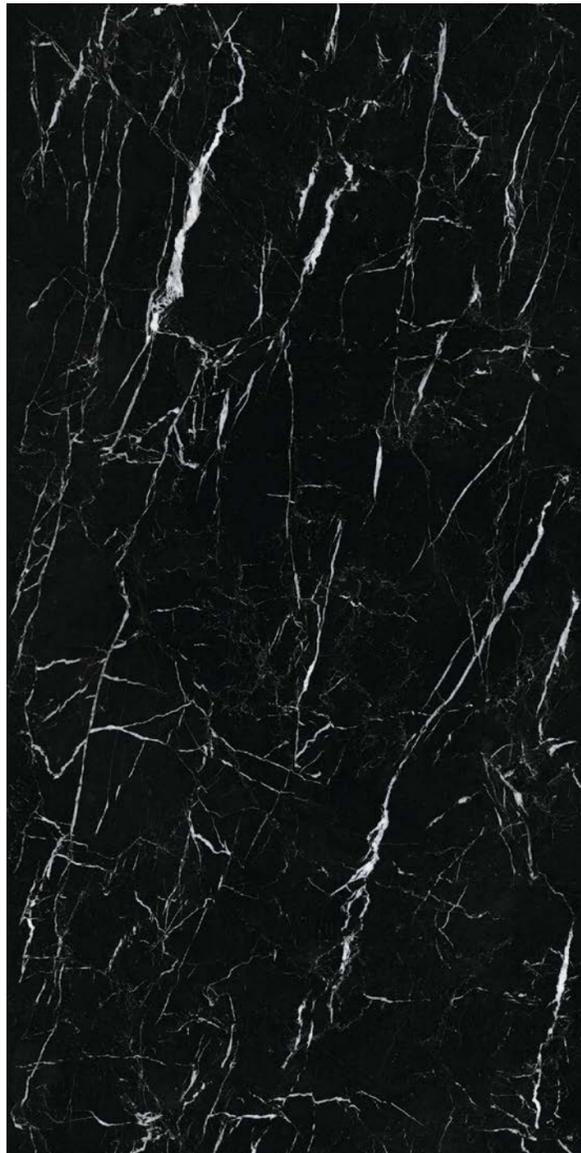

NERO



MARQUINA NERO Lucidato Ret.

Spessore . Thickness . Epaisseur . Stärke - 6 mm

Lastre in gres porcellanato pressate a secco. Dry-pressed porcelain stoneware slabs. Dalles en grès cérame pressées à sec. Trocken gepresste Platten aus Feinsteinzeug.

Spessore . Thickness . Epaisseur . Stärke - 9 mm

Gres porcellanato colorato in massa. Full-body coloured porcelain stoneware. Grès cérame coloré dans la masse. In der Masse gefärbtes Feinsteinzeug.

TABELLA RIEPILOGATIVA

Summary table
Tableau récapitulatif
Zusammenfassende Tabelle

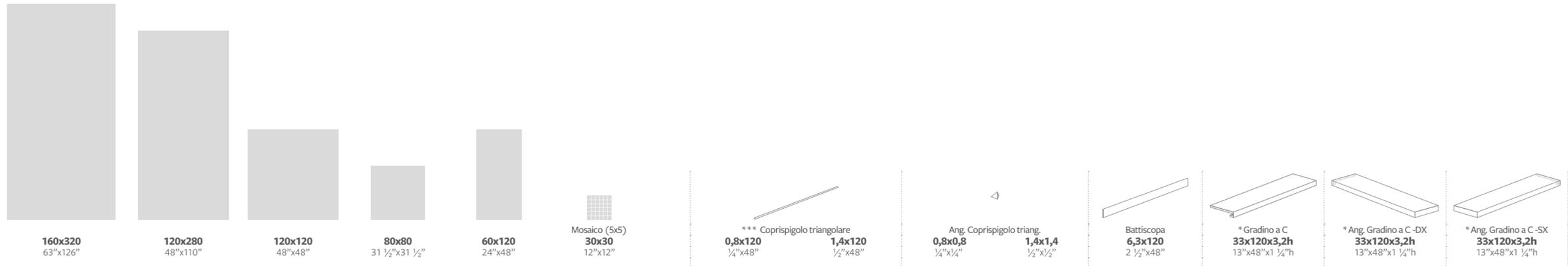

SPESSORE - THICKNESS - EPAISSEUR - STÄRKE		6 mm	6 mm	6 mm	6 mm	▼ 9 mm	▼ 9 mm	6 mm	▼ 9 mm	6 mm	▼ 9 mm	▼ 9 mm	▼ 9 mm	▼ 9 mm	▼ 9 mm
	NERO ○ Lucidato Ret.	123010	123020	123030	123050	123040	123201	123401	123402	123405	123406	123101	123301	123302	123303
	MQ x pezzo - Sqm x pcs	5,12	3,36												
	Kg x pezzo - Kg x pcs	74,1	48,6												
	IMBALLI - PACKAGING EMBALLAGE - VERPACKUNG														
		Cassa Crate 175x344x30h	Cassa Crate 145x292x34h	Pallet speciale Special pallet 123x144	Pallet 80x120	Pallet 80x120	Pallet 80x120					Pallet 80x120	Pallet 80x120	Pallet 80x120	Pallet 80x120
	N°	14	20												
	m²	71,68	67,2												
	** Kg	1158	1062												
				2	3	2	11	6	6			9	2	1	1
				2,88	1,92	1,44									
				42	28,1	29	19,5	1,2	1,8			14,2	21	10,5	10,5
				24	40	30									
				69,12	76,8	43,2									
				1061	1144	890									
				65	95	75									
	Imballo (Tara) - Packaging (Tare)	(120)	(90)	(53)	(20)	(20)	(20)					(20)	(20)	(20)	(20)
		Cavalletto A-Frame 75x330x200h	Cavalletto A-Frame 75x290x160h												
	N°	44	44												
	m²	225,28	147,84												
	** Kg	3431	2259												
	Imballo (Tara) - Packaging (Tare)	(170)	(120)												

I pesi riportati in tabella sono indicativi e potrebbero essere soggetti a leggere variazioni.
The weights stated in the chart may undergo slight changes for production reasons.
Les poids indiqués dans le tableau peuvent subir de légères variations pour des raisons de production.
Die in der Tabelle angegebenen Gewichte können aus Produktionsgründen geringfügigen Abweichungen unterliegen.

Non si garantisce l'abbinabilità tra fondi di spessori diversi e tra fondo e pezzo speciale.
It is not guaranteed that background tiles with different thicknesses can be used together, nor is it guaranteed for background tiles and trims.
Nous ne garantissons pas la possibilité de combiner des carrelages de sol de différentes épaisseurs et un carrelage de sol avec une pièce spéciale.
Die Kombinierbarkeit von Fliesen unterschiedlicher Stärke sowie zwischen Fliese und Formteil kann nicht garantiert werden.

▼ Gli articoli nel nuovo spessore 9 mm saranno disponibili ad esaurimento dello stock esistente in spessore 10 mm.
9 mm items will be available once the current 10 mm stock we have has run out.
Les articles de 9 mm d'épaisseur seront disponibles dès que le stock en 10 mm sera terminé.
Die 9 mm Artikel werden verfügbar sein, sobald die 10 mm Lagerbestände abverkauft sind.

* A disposizione solo su richiesta. Tempi di consegna 30 gg.
Available upon request only. Delivery terms: 30 days.
Disponible seulement sur requête. Délais de livraison: 30 jours.
Verfügbar auf Anfrage. Lieferzeit: 30 Tage.

** Il peso è comprensivo dell'imballo.
The total weight includes the packaging.
Le poids comprend aussi l'emballage.
Das Gesamtgewicht enthält auch die Verpackung.

*** Vendita a scatola completa.
Full box sale.
Vente à la boîte complète.
Volle Kartons.

○ Lucidato e rettificato.
Glossy rectified.
Brillant et rectifié.
Glossy/Shiny und rektifiziert.



WOOD

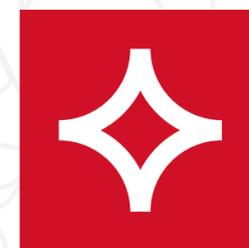

EVOQUE 350

 **Tagina**
ITALY'S BEST SURFACES

EVOQUE

EVOQUE si ispira a un rovere italiano, un legno sobrio ed elegante, lasciato "al naturale" per evocare negli ambienti sensazioni di calore, comfort e relax. Una collezione che sposa stile e tecnologia, fondamentale per ottenere un effetto superficiale vellutato al tatto ma al contempo contraddistinto dal basso grado di riflessione della luce tipico del legno naturale.

La sensazione di realismo si amplifica nelle grafiche, grazie all'utilizzo dell'alta definizione per ricreare venature e nodi con estrema precisione di dettaglio. 5 le tonalità cromatiche disponibili, sia in versione da interno sia da esterno, anche nel grande formato 26,5x180 cm.

Inspired by an Italian oak, a sober and elegant wood, **EVOQUE** has been left 'natural' to provide rooms with a feeling of warmth, comfort, and relaxation. The collection combines style with technology, through the essential engineering required to produce a surface that is soft to the touch and offers the low level of reflection that is typical of natural wood.

The realism is amplified by the patterns, through the high definition graphics use to create graining and knots with the utmost attention to detail. The line offers five colour shades, which are available in both indoor and outdoor versions, as well as in a large version measuring 26.5x180 cm.

EVOQUE est inspiré du chêne italien, un bois sobre et élégant, laissé « au naturel » pour évoquer des sensations de chaleur, de confort et de détente dans les espaces. Une collection qui allie style et technologie, fondamentale pour obtenir un effet de surface velouté au toucher mais qui se distingue en même temps par le faible degré de réflexion de la lumière, typique du bois naturel.

La sensation de réalisme est amplifiée dans les graphismes, grâce à l'utilisation de la haute définition pour recréer les veines et les nœuds avec des détails extrêmement précis. 5 tons disponibles, dans les versions pour l'intérieur et l'extérieur, également en grand format 26,5x180 cm.

EVOQUE ist von einer italienischen Eiche inspiriert, einem schlichten und eleganten Holz, das "natürlich" ist und ein Gefühl von Wärme, Komfort und Entspannung in den Zimmern hervorruft. Eine Kollektion, die Stil und Technologie vereint, die zur Erzielung eines samtigen Oberflächeneffektes bei der Berührung unerlässlich ist und sich gleichzeitig durch den für Naturholz typischen geringen Grad der Lichtreflexion auszeichnet.

Das Gefühl der Echtheit des Holzes wird in der Grafik durch die Verwendung der hohen Auflösung verstärkt, um Aderungen und Astknoten mit äußerster Detailgenauigkeit nachzubilden. Erhältlich sind auch im Großformat von 26,5 x 180 cm 5 Farbtöne, sowohl bei der Version für den Innen- als auch bei der für den Außenbereich.

100% Made in Italy



RIVESTIMENTO . WALL: DOUSSIE 26,5x180 Nat. Ret. - Collection MARQUINA, NERO 120x280 Lucidato Ret.
ARREDI . FURNITURE: Collection MARQUINA, NERO 120x280 Lucidato Ret.
PAVIMENTO . FLOOR: DOUSSIE 26,5x180 Nat. Ret.



DOUSSIE 26,5x180 Nat. Ret.









DOUGLAS 40x120 20 mm Nat. Ret. R11

Special pieces for swimming pool:

DOUGLAS Griglia 20x60 20 mm Nat. Ret. R11

DOUGLAS Angolare Griglia 20x60 20 mm Nat. Ret. R11

DOUGLAS Gradone Griglia Bordo Piscina 40x120 20 mm Nat. Ret. R11

DOUGLAS Angolare Gradone Grip Bordo Piscina 40x120 20 mm Nat. Ret. R11

FORMATI
Sizes / Formats / Formate

9 mm . 26,5x180 - 10 1/2"x71" / 20x120 - 8"x48"
 9 mm R11 . 20x120 - 8"x48"
 20 mm R11 . 40x120 - 16"x48"

COLORI

Colours / Couleurs / Farben



KORINA



ROVERE



DOUSSIE



DOUGLAS



BAHIA

CONTINUITÀ PROGETTUALE INDOOR-OUTDOOR

Design continuity indoors and out / Continuité conceptuelle à l'intérieur et à l'extérieur / Entwurfskontinuität im innen- und Aussenbereich

**INDOOR**

SPESORE
THICKNESS
9mm

Soluzioni contemporanee per l'interior design
 Contemporary solutions for interior design.
 Solutions contemporaines pour le design intérieur.
 Zeitgemäße Lösungen für das Interior Design.



R11
A+B+C

OUTDOOR

SPESORE
THICKNESS
9mm

SPESORE
THICKNESS
20mm

Versatilità e prestazioni per la progettazione in esterna
 Versatility and performance for outdoor design.
 Polyvalence et performance pour l'aménagement extérieur.
 Vielseitigkeit und Leistungen für Outdoor-Design.

SISTEMI DI POSA

Laying systems / Systemes de pose / Verlegearten

Posa su erba
 Laying on grass
 Pose sur l'herbe
 Verlegung auf Wiese



Posa su sabbia
 Laying on sand
 Pose sur sable
 Verlegung auf Sand



Posa sopraelevata
 Raised laying
 Pose surélevée
 Verlegung auf Stützlagern



Posa su ghiaia
 Laying on gravel
 Pose sur gravier
 Verlegung auf Kies



Posa tradizionale
 Standard laying
 Pose traditionnelle
 Herkömmliche Verlegung



Spessore . Thickness . Epaisseur . Stärke - 9 mm**Gres porcellanato colorato in massa.** Full-body coloured porcelain stoneware. Grès cérame coloré dans la masse. In der Masse gefärbtes Feinsteinzeug.**INDOOR**TABELLA RIEPILOGATIVA
Summary table
Tableau récapitulatif
Zusammenfassenden Tabelle**26,5x180**
10 1/2"x71"**20x120**
8"x48"**Battiscopa**
6,3x120
2 1/2"x48"***** Coprispigolo triangolare**
1,4x120
1/2"x48"**Ang. Coprispigolo triang.**
1,4x1,4
1/2"x 1/2"*** Gradino a C**
33x120x3,2h
13"x48"x1 1/4"h*** Ang. Gradino a C - SX**
33x120x3,2h
13"x48"x1 1/4"h*** Ang. Gradino a C - DX**
33x120x3,2h
13"x48"x1 1/4"h

SPESSORE - THICKNESS - EPAISSEUR - STÄRKE		▼ 9 mm	▼ 9 mm	▼ 9 mm	▼ 9 mm	▼ 9 mm	▼ 9 mm	▼ 9 mm	▼ 9 mm
	KORINA <input type="checkbox"/> Nat. Ret.	105060	105106	105151	105170	105175	105180	105181	105182
	ROVERE <input type="checkbox"/> Nat. Ret.	105064	105119	105159	105171	105176	105183	105184	105185
	DOUSSIE <input type="checkbox"/> Nat. Ret.	105066	105118	105157	105172	105177	105186	105187	105188
	DOUGLAS <input type="checkbox"/> Nat. Ret.	105062	105110	105153	105173	105178	105189	105190	105191
	BAHIA <input type="checkbox"/> Nat. Ret.	105067	105114	105155	105174	105179	105192	105193	105194
IMBALLI - PACKAGING EMBALLAGE - VERPACKUNG									
		Pallet speciale Special pallet 97x198	Pallet 80x120	Pallet 80x120		Pallet 80x120	Pallet 80x120	Pallet 80x120	Pallet 80x120
N°									
m²									
Kg									
x		3	6	9	6		2	1	1
m² x		1,43	1,44						
Kg x		29	29	14,2	1,8		21	10,5	10,5
x		42	24						
m² x		60,06	34,56						
** Kg x		1288	716						
h x		70	56						
Imballo (tara) - Packaging (tare)		(70)	(20)	(20)		(20)	(20)	(20)	(20)

▼ Gli articoli nel nuovo spessore 9 mm saranno disponibili ad esaurimento dello stock esistente in spessore 10 mm.
9 mm items will be available once the current 10 mm stock we have has run out.
Les articles de 9 mm d'épaisseur seront disponibles dès que le stock en 10 mm sera terminé.
Die 9 mm Artikel werden verfügbar sein, sobald die 10 mm Lagerbestände abverkauft sind.

I pesi riportati in tabella sono indicativi e potrebbero essere soggetti a leggere variazioni.
The weights stated in the chart may undergo slight changes for production reasons.
Les poids indiqués dans le tableau peuvent subir de légères variations pour des raisons de production.
Die in der Tabelle angegebenen Gewichte können aus Produktionsgründen geringfügigen Abweichungen unterliegen.

Non si garantisce l'abbinabilità tra fondi di spessori diversi e tra fondo e pezzo speciale.
It is not guaranteed that background tiles with different thicknesses can be used together, nor is it guaranteed for background tiles and trims.
Nous ne garantissons pas la possibilité de combiner des carrelages de sol de différentes épaisseurs et un carrelage de sol avec une pièce spéciale.
Die Kombinierbarkeit von Fliesen unterschiedlicher Stärke sowie zwischen Fliese und Formteil kann nicht garantiert werden.

* A disposizione solo su richiesta. Tempi di consegna 30 gg.
Available upon request only. Delivery terms: 30 days.
Disponible seulement sur requête. Délais de livraison: 30 jours.
Verfügbar auf Anfrage. Lieferzeit: 30 Tage.

** Il peso è comprensivo dell'imballo.
The total weight includes the packaging.
Le poids comprend aussi l'emballage.
Das Gesamtgewicht enthält auch die Verpackung.

*** Vendita a scatola completa.
Full box sale.
Vente à la boîte complète.
Volle Kartons.

Naturale e rettificato.
Natural rectified.
Naturel et rectifié.
Natur Oberfläche und rektifiziert.

Spessore . Thickness . Epaisseur . Stärke - 9 mm R11 - 20 mm R11**Gres porcellanato colorato in massa.** Full-body coloured porcelain stoneware. Grès cérame coloré dans la masse. In der Masse gefärbtes Feinsteinzeug.**OUTDOOR**TABELLA RIEPILOGATIVA
Summary table
Tableau récapitulatif
Zusammenfassenden Tabelle

				
SPESSORE - THICKNESS - EPAISSEUR - STÄRKE		▼ 9 mm	20 mm	9,5 mm
	□ Nat. Ret.	105123	105096	
	■ Nat. Nat.			105160
	□ Nat. Ret.	105127	105103	
	■ Nat. Nat.			105161
	□ Nat. Ret.	105129	105102	
	■ Nat. Nat.			105162
	□ Nat. Ret.	105125	105098	
	■ Nat. Nat.			105163
	□ Nat. Ret.	105131	105100	
	■ Nat. Nat.			105164
IMBALLI - PACKAGING EMBALLAGE - VERPACKUNG				
		Pallet	Pallet	Pallet
		80x120	80x120	80x120
N°				
m ²				
Kg				
		6	2	6
m ² x		1,44	0,96	
Kg x		29	43	7,5
		24	24	
m ² x		34,56	23,04	
** Kg x		716	1052	
		56	68	
Imballo (tara) - Packaging (tare)		(20)	(20)	(20)

I pesi riportati in tabella sono indicativi e potrebbero essere soggetti a leggere variazioni.
The weights stated in the chart may undergo slight changes for production reasons.
Les poids indiqués dans le tableau peuvent subir de légères variations pour des raisons de production.
Die in der Tabelle angegebenen Gewichte können aus Produktionsgründen geringfügigen Abweichungen unterliegen.

Non si garantisce l'abbinabilità tra fondi di spessori diversi e tra fondo e pezzo speciale.
It is not guaranteed that background tiles with different thicknesses can be used together, nor is it guaranteed for background tiles and trims.
Nous ne garantissons pas la possibilité de combiner des carrelages de sol de différentes épaisseurs et un carrelage de sol avec une pièce spéciale.
Die Kombinierbarkeit von Fliesen unterschiedlicher Stärke sowie zwischen Fliese und Formteil kann nicht garantiert werden.

□ Naturale e rettificato. Natural rectified. Naturel et rectifié. Natur Oberfläche und rektifiziert.
■ Naturale e naturale. Natural and natural. Naturel et naturel. Natur natur
△ Monolitico. Monolithic step. Monolitico. Monolithische Stufenplatte

* A disposizione solo su richiesta. Tempi di consegna 30 gg.
Available upon request only. Delivery terms: 30 days.
Disponible seulement sur requête. Délais de livraison: 30 jours.
Verfügbar auf Anfrage. Lieferzeit: 30 Tage.

** Il peso è comprensivo dell'imballo.
The total weight includes the packaging.
Le poids comprend aussi l'emballage.
Das Gesamtgewicht enthält auch die Verpackung.

PEZZI SPECIALI PER ESTERNO 20 mm R11 - □ Nat. Ret.

Special pieces for outdoor - Pièces spéciales pour extérieur - Formteile für Aussenbereich

		
* Gradone 40x120 . 16"x48"	* Ang. Gradone - SX 40x120 . 16"x48"	* Ang. Gradone - DX 40x120 . 16"x48"
		
* Gradone grip 40x120 . 16"x48"	* Ang. Gradone grip - SX 40x120 . 16"x48"	* Ang. Gradone grip - DX 40x120 . 16"x48"
		
* Elemento a L 33x120x4h . 13"x48"x1 1/2"h	* Elemento a L SX 33x120x4h . 13"x48"x1 1/2"h	* Elemento a L DX 33x120x4h . 13"x48"x1 1/2"h

PEZZI SPECIALI PER PISCINA 20 mm R11 - □ Nat. Ret.

Special pieces for swimming pool - Pièces spéciales pour piscine - Formteile für Schwimmbad

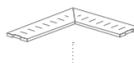
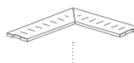
		
* Gradone bordo piscina 40x120 . 16"x48"	* Ang. Gradone bordo piscina - SX 40x120 . 16"x48"	* Ang. Gradone bordo piscina - DX 40x120 . 16"x48"
		
* Gradone grip bordo piscina 40x120 . 16"x48"	* Ang. Gradone grip bordo piscina - SX 40x120 . 16"x48"	* Ang. Gradone grip bordo piscina - DX 40x120 . 16"x48"
		
* Gradone svasato bordo piscina 40x120 . 16"x48"	* Ang. Gradone svasato bordo piscina - SX 40x120 . 16"x48"	* Ang. Gradone svasato bordo piscina - DX 40x120 . 16"x48"
		
* Griglia 20x60 . 8"x24"	* Griglia SX 20x60 . 8"x24"	* Griglia DX 20x60 . 8"x24"

Per maggiori informazioni su imballi e codici articolo consultare la Sezione Tecnica: "Pezzi speciali per esterno" e "Pezzi speciali per piscina".
For more information on packaging and item codes, please refer to the Technical Section: "Special pieces for outdoor" and "Special pieces for swimming pools".
Pour plus d'informations sur les emballages et les codes articles, vous pouvez consulter la Section Technique: "Pièces spéciales pour extérieur" et "Pièces spéciales pour piscines".
Weitere Informationen für Verpackungen und Artikelcodes finden Sie im Technischen Abschnitt: "Formteile für Außenbereich" und "Formteile für Schwimmbad".



Supporti per pavimentazioni sopraelevate nella Sezione "Posa sopraelevata".
Supports for raised paving system, please refer to the Section: "Raised Laying".
Supports pour le système de carrelage surélevé dans la Section "Pose surélevée".
Stelzlagern für Doppelboden Wire im Abschnitt "Verlegung auf Stelzlagern".

* A disposizione solo su richiesta. Tempi di consegna 30 gg.
Available upon request only. Delivery terms: 30 days.
Disponible seulement sur requête. Délais de livraison: 30 jours.
Verfügbar auf Anfrage. Lieferzeit: 30 Tage.

┌ Costa retta. Straight edge. Bord droit. Gerade Kante.
┐ Costa toro. Bullnose edge. Bord boudin. Abgerundete Kante.



DECORS

- FOREST** ³²²
- JAY VINTAGE** ³²⁴
- GARDENS** ³²⁶

DECORS è un progetto di decorazione studiato per esaltare tutti i prodotti **Tagina**, senza limiti di texture, genere o formato. Si tratta di singoli decori realizzati sia su grande lastra che su grès tradizionale, studiati per essere “trasversali” ed abbinabili ad ogni collezione in gamma **Tagina**, al fine da lasciare libero chiunque di poter esprimere la propria massima creatività. Un progetto all’insegna della flessibilità perché tutti i decori sono ordinabili singolarmente, e non in set e composizioni.

DECORS is a decoration project designed to enhance all **Tagina** products, without limits of texture, genre, or format. These are single decorations made both on large slabs and on traditional stoneware, designed to be universal to match any collection in the **Tagina** range, in order to let everyone express all their creativity. A project characterized by flexibility, because all the decorations can be ordered individually, and not in sets and compositions.

DECORS est un projet de décoration conçu pour mettre en valeur tous les produits **Tagina**, sans limites de texture, de genre ou de format. Il s’agit de décors uniques réalisés aussi bien sur de grandes dalles que sur des grès traditionnels, conçus pour être « transversaux » et combinables avec toutes les collections de la gamme **Tagina**, afin de laisser à chacun la liberté d’exprimer sa créativité maximale. Ce projet est synonyme de flexibilité, car tous les décors peuvent être commandés individuellement, et non en ensembles et compositions.

DECORS ist ein Dekorationsprojekt, das darauf abzielt, alle Produkte von **Tagina** ohne Einschränkungen hinsichtlich Textur, Art oder Format hervorzuheben. Es handelt sich um einzelne Dekore, die sowohl auf großen Platten als auch auf traditionellem Steinzeug realisiert werden. Sie sind „transversal“ und an jede Kollektion der **Tagina**-Produktreihe anpassbar, wodurch jeder seiner Kreativität freien Lauf lassen kann. Ein Projekt im Zeichen der Flexibilität, da alle Dekore einzeln und nicht im Set oder in Kompositionen bestellt werden können.





FOREST

120x280 - 48"x110"



60x120 - 24"x48"





JAY VINTAGE

120x280 - 48"x110"

PEARL



60x120 - 24"x48"

ROSA





GARDENS

60x120 - 24"x48"

GIALLO



VIOLA



ROSA

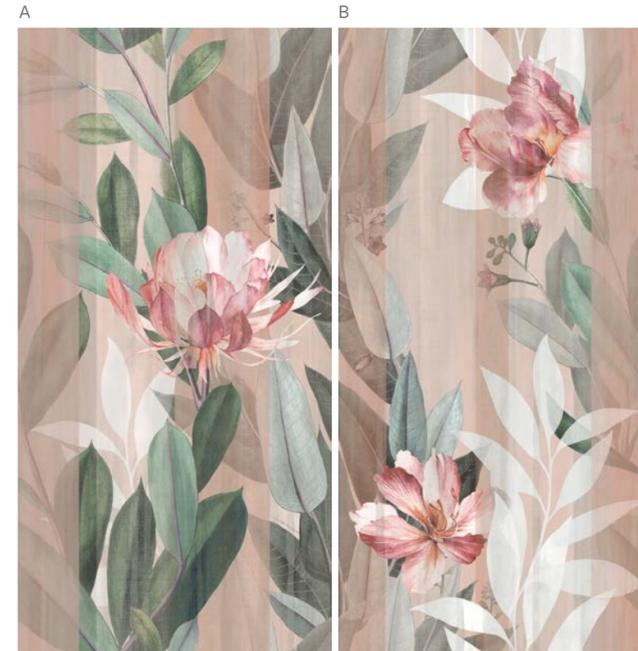

FOREST

INDOOR

TABELLA RIEPILOGATIVA
Summary table
Tableau récapitulatif
Zusammenfassenden Tabelle



120x280
48"x110"



60x120
24"x48"

SPESSORE - THICKNESS - EPAISSEUR - STÄRKE		6 mm	▼ 9 mm
FOREST A	<input type="checkbox"/> Nat. Ret.	130001	-
FOREST B	<input type="checkbox"/> Nat. Ret.	130002	-
 FOREST A	<input type="checkbox"/> Nat. Ret.	-	130051
FOREST B	<input type="checkbox"/> Nat. Ret.	-	130052
FOREST C	<input type="checkbox"/> Nat. Ret.	-	130053
FOREST D	<input type="checkbox"/> Nat. Ret.	-	130054
			
		Cassa Crate 292x145x34h	Pallet
		N° m²	N° m²
		** Kg	** Kg
		 x	 x
		1	2

GARDENS

INDOOR

TABELLA RIEPILOGATIVA
Summary table
Tableau récapitulatif
Zusammenfassenden Tabelle



60x120
24"x48"

SPESSORE - THICKNESS - EPAISSEUR - STÄRKE		▼ 9 mm
 GARDENS GIALLO A	<input type="checkbox"/> Nat. Ret.	130070
GARDENS GIALLO B	<input type="checkbox"/> Nat. Ret.	130071
 GARDENS ROSA A	<input type="checkbox"/> Nat. Ret.	130072
GARDENS ROSA B	<input type="checkbox"/> Nat. Ret.	130073
 GARDENS VIOLA A	<input type="checkbox"/> Nat. Ret.	130074
GARDENS VIOLA B	<input type="checkbox"/> Nat. Ret.	130075
		
		Pallet
		N° m²
		** Kg
		 x
		2

JAY VINTAGE

INDOOR

TABELLA RIEPILOGATIVA
Summary table
Tableau récapitulatif
Zusammenfassenden Tabelle



120x280
48"x110"



60x120
24"x48"

SPESSORE - THICKNESS - EPAISSEUR - STÄRKE		6 mm	▼ 9 mm
JAY VINTAGE PEARL A	<input type="checkbox"/> Nat. Ret.	130003	-
JAY VINTAGE PEARL B	<input type="checkbox"/> Nat. Ret.	130004	-
 JAY VINTAGE PEARL A	<input type="checkbox"/> Nat. Ret.	-	130055
JAY VINTAGE PEARL B	<input type="checkbox"/> Nat. Ret.	-	130056
JAY VINTAGE PEARL C	<input type="checkbox"/> Nat. Ret.	-	130057
JAY VINTAGE ROSA A	<input type="checkbox"/> Nat. Ret.	130005	-
JAY VINTAGE ROSA B	<input type="checkbox"/> Nat. Ret.	130006	-
 JAY VINTAGE ROSA A	<input type="checkbox"/> Nat. Ret.	-	130058
JAY VINTAGE ROSA B	<input type="checkbox"/> Nat. Ret.	-	130059
JAY VINTAGE ROSA C	<input type="checkbox"/> Nat. Ret.	-	130060
			
		Cassa Crate 292x145x34h	Pallet
		N° m²	N° m²
		** Kg	** Kg
		 x	 x
		1	2



120x280
48"x110"



60x120
24"x48"

SPESSORE - THICKNESS - EPAISSEUR - STÄRKE		6 mm	▼ 9 mm
JAY VINTAGE ANTRACITE A	<input type="checkbox"/> Nat. Ret.	130007	-
JAY VINTAGE ANTRACITE B	<input type="checkbox"/> Nat. Ret.	130008	-
 JAY VINTAGE ANTRACITE A	<input type="checkbox"/> Nat. Ret.	-	130061
JAY VINTAGE ANTRACITE B	<input type="checkbox"/> Nat. Ret.	-	130062
JAY VINTAGE ANTRACITE C	<input type="checkbox"/> Nat. Ret.	-	130063
JAY VINTAGE AVIO A	<input type="checkbox"/> Nat. Ret.	130009	-
JAY VINTAGE AVIO B	<input type="checkbox"/> Nat. Ret.	130010	-
 JAY VINTAGE AVIO A	<input type="checkbox"/> Nat. Ret.	-	130064
JAY VINTAGE AVIO B	<input type="checkbox"/> Nat. Ret.	-	130065
JAY VINTAGE AVIO C	<input type="checkbox"/> Nat. Ret.	-	130066
JAY VINTAGE AZZURRO A	<input type="checkbox"/> Nat. Ret.	130011	-
JAY VINTAGE AZZURRO B	<input type="checkbox"/> Nat. Ret.	130012	-
 JAY VINTAGE AZZURRO A	<input type="checkbox"/> Nat. Ret.	-	130067
JAY VINTAGE AZZURRO B	<input type="checkbox"/> Nat. Ret.	-	130068
JAY VINTAGE AZZURRO C	<input type="checkbox"/> Nat. Ret.	-	130069
			
		Cassa Crate 292x145x34h	Pallet
		N° m²	N° m²
		** Kg	** Kg
		 x	 x
		1	2

▼ Gli articoli nel nuovo spessore 9 mm saranno disponibili ad esaurimento dello stock esistente in spessore 10 mm.
9 mm items will be available once the current 10 mm stock we have has run out.
Les articles de 9 mm d'épaisseur seront disponibles dès que le stock en 10 mm sera terminé.
Die 9 mm Artikel werden verfügbar sein, sobald die 10 mm Lagerbestände abverkauft sind.

Spessore . Thickness . Epaisseur . Stärke - 6 mm
Lastre in gres porcellanato pressate a secco.
Dry-pressed porcelain stoneware slabs.
Dalles en grès cérame pressées à sec.
Trocken gepresste Platten aus Feinsteinzeug.

Spessore . Thickness . Epaisseur . Stärke - 9 mm
Gres porcellanato colorato in massa.
Full-body coloured porcelain stoneware.
Grès cérame coloré dans la masse.
In der Masse gefärbtes Feinsteinzeug.

☞ Da rivestimento.
Wall tile.
Décor pour revêtement.
Für Wandbelag.

☐ Naturale e rettificato.
Natural and rectified.
Naturel et rectifié.
Natur Oberfläche und rektifiziert.

Tutti i decori a disposizione solo su richiesta. Tempi di consegna 30 gg.
All decors are available upon request only. Delivery terms: 30 days.
Tous les décors sont disponible seulement sur requête. Délais de livraison: 30 jours.
Alle Dekore sind auf Anfrage verfügbar. Lieferzeit: 30 Tage.

INFORMAZIONI TECNICHE

TECHNICAL INFORMATION
INFORMATIONS TECHNIQUES
TECHNISCHE INFORMATIONEN

INDOOR 380

Soluzioni per complementi di arredo 380

Solution for furniture.
Solutions pour les accessoires d'ameublement.
Lösungen, um Einrichtungen zu gestalten.

Pezzi speciali 384

Special pieces.
Pièces spéciales.
Spezialteile.

OUTDOOR 386

Pezzi speciali per esterno 390

Special pieces for outdoor.
Pièces spéciales pour l'extérieur.
Formteile für Aussenbereich.

Pezzi speciali per piscina 391

Special pieces for swimming pool.
Pièces spéciales pour piscine.
Formteile für Schwimmbad.

IMBALLI 416

Packaging.
Emballage.
Verpackung.

SERVIZIO CONSEGNE FINO A SASSUOLO 416

Delivery service to Sassuolo.
Service de livraisons jusqu'à Sassuolo.
Lieferservice bis nach Sassuolo.

CERTIFICAZIONI 417

Certifications.
Certifications.
Zertifizierung.

CATALOGHISTICA TECNICA 417

Technical catalogues.
Catalogues techniques.
Technische Kataloge.

CONDIZIONI GENERALI DI VENDITA 418

General terms and conditions of sale.
Condition générales de vente.
Allgemeine Verkaufsbedingungen.

CARATTERISTICHE TECNICHE 422

Technical features.
Caractéristiques techniques.
Technische Eigenschaften.

Soluzioni per complementi di arredo

Solution for furniture.
Solutions pour les accessoires d'ameublement.
Lösungen, um Einrichtungen zu gestalten.



**IL GRES PORCELLANATO TAGINA
PROPONE NUOVE SOLUZIONI
E ALIMENTA NUOVE ISPIRAZIONI
PER LA PROGETTAZIONE CONTEMPORANEA.**



RIVESTIMENTO . WALL:
ONICE REALE CRISTALLO 120x280 Lucidato Ret.
MARQUINA NERO 120x280 Lucidato Ret

PAVIMENTO . FLOOR:
ONICE REALE CRISTALLO 120x280 Lucidato Ret.

SCALA . STAIRS:
ONICE REALE CRISTALLO 120x120 Lucidato Ret.
ONICE REALE Coprispigo
CRISTALLO 0,8x120 Lucidato Ret.

PORTA . DOOR:
ONICE REALE CRISTALLO 120x280 Lucidato Ret.

CUCINA . KITCHEN:
FULL COLOURS MIDNIGHT Lucidato Ret.

Tagina porcelain stoneware offers new solutions and fuels new inspirations for contemporary design.

Le grès cérame Tagina offre de nouvelles solutions et est source de nouvelles inspirations pour le design contemporain.

Das Feinsteinzeug von Tagina bietet neue Lösungen und liefert neue Inspirationen für zeitgenössisches Design.

Oltre a raffinati pavimenti e rivestimenti ora è possibile realizzare complementi di arredo perfettamente coordinati con lo stile delle superfici. La versatilità dello spessore 6 mm disponibile nei formati delle grandi lastre, consente di rivestire ante e top per cucine, porte, mobili per il bagno, tavoli di ogni forma e dimensione. Tagina, afferma un modo originale di immaginare lo spazio dove ogni elemento contribuisce a definire un'atmosfera unica e irripetibile.

In addition to refined floors and walls, it is now possible to create furnishing accessories perfectly coordinated with the style of the surfaces. The versatility of 6 mm thickness, also available in the large slabs, allows you to cover unit doors and counter tops for kitchens, doors, bathroom furniture and tables of all shapes and sizes. Tagina showcases an original way of imagining the space where each element contributes to defining a unique and unrepeatable atmosphere.

En plus des sols et des murs raffinés, il est maintenant possible de créer des accessoires d'ameublement parfaitement coordonnés avec le style des surfaces. La polyvalence de l'épaisseur de 6 mm disponible dans les tailles de grandes dalles, vous permet de couvrir les portes et les dessus pour les cuisines, portes, meubles de salle de bains, tables de toutes formes et tailles. Tagina, affirme sa façon originale d'imaginer l'espace où chaque élément contribue à définir une atmosphère unique et irremplaçable.

Neben edlen Böden und Verkleidungen ist es nun möglich, Einrichtungsaccessoires zu kreieren, die perfekt auf den Stil der Oberflächen abgestimmt sind. Die Vielseitigkeit der Dicke von 6 mm, die bei den großformatigen Platten erhältlich ist, ermöglicht die Verkleidung von Küchenschranktüren und Küchenarbeitsplatten, Türen, Badezimmermöbeln und Tischen aller Formen und Größen. Tagina bietet ein originelles Raumkonzept, bei dem jedes Element dazu beiträgt, eine einzigartige und unwiederholbare Atmosphäre zu schaffen.



Pezzi speciali: massima cura in ogni dettaglio

Special pieces: the utmost care in every detail.
Pièces spéciales : le soin maximal dans le moindre détail.
Formteile: maximale Sorgfalt in jedem Detail.



Il fascino tradizionale del gradino a "C"

The traditional appeal of the "C" step.
Le charme traditionnel de l'étape « C ».
Der traditionelle Charme der „C“-Stufe.

Tagina pone attenzione a tutte le componenti architettoniche degli spazi da abitare. Ai gradini sono dedicati pezzi speciali appositamente progettati per ottenere il massimo risultato estetico. La gamma comprende un elemento "gradino a C" al quale si possono affiancare gli elementi che completano gli angoli sinistro e destro.

Tagina takes great care over all the architectural elements of the living spaces. Special pieces are used for the stairs, specially designed to obtain the maximum aesthetic result. The range includes a "C-step" element which can be combined with the elements that complete the left and right corners.

Tagina prête attention à toutes les composantes architecturales des espaces de vie. Les étapes sont dédiées à des pièces spéciales spécialement conçues pour obtenir un résultat esthétique maximal. La gamme comprend un élément « marche en C » auquel vous pouvez assortir les autres éléments qui complètent les angles gauche et droit.

Tagina achtet auf alle architektonischen Komponenten der Wohnräume. Den Stufen sind Spezialteile gewidmet, um ein optimales ästhetisches Ergebnis zu erzielen. Das Sortiment umfasst ein „C-Stufen-Element“, das durch Elemente zur Vervollständigung der linken und rechten Ecke ergänzt werden kann.

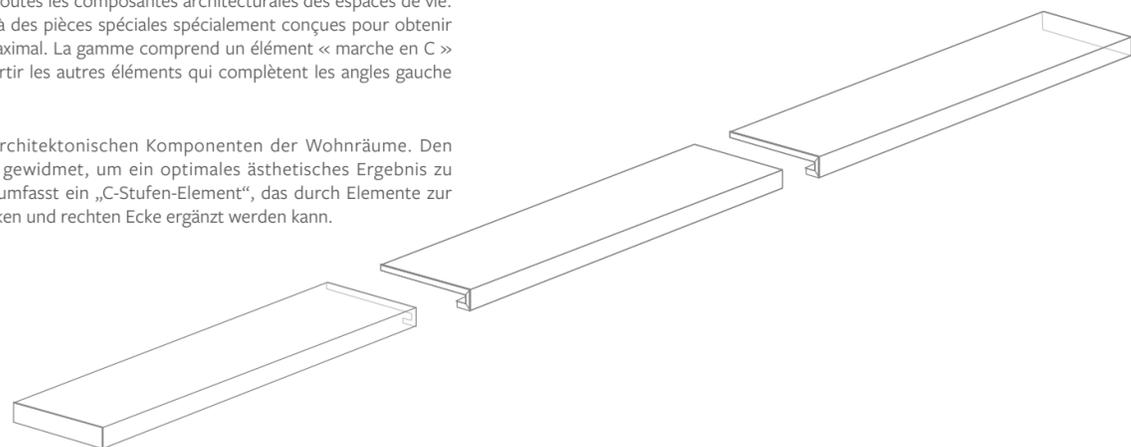

Il "coprispigolo triangolare"

The "triangular edge cover".
Le « cache-arête triangulaire ».
„Dreieckiger Kantenschutz“.

La gamma Tagina include gli elementi "Coprispigolo triangolare" e l'"Angolo Coprispigolo triangolare". Essi consentono di risolvere con eleganza e semplicità problematiche legate alla congiunzione delle lastre in presenza di spigoli e angoli. È possibile adottare questa soluzione sia a rivestimento che a pavimento ad esempio per realizzare gradini o per comporre volumi geometrici.

The range of Tagina includes the "Triangular edge cover and triangular corner edge cover" elements. They allow problems encountered to be solved elegantly and simply when joining slabs where there are edges and corners. It is possible to adopt this solution both for cladding and flooring, e.g. to create steps or compose geometric volumes.

La gamme Tagina comprend les éléments « Cache-arête triangulaire et Angle Cache-arête Triangulaire ». Ils permettent de résoudre avec élégance et simplicité les problèmes liés à l'assemblage des dalles en présence de bords et de coins. Il est possible d'adopter cette solution aussi bien pour le revêtement que pour le dallage, par exemple pour créer des marches ou composer des volumes géométriques.

Das Sortiment Tagina umfasst das Element „Dreieckiger Kantenschutz und Dreieckige Eckabdeckung“. Beide Elemente ermöglichen, mit Eleganz und Einfachheit alle Probleme zu lösen, die mit dem Zusammenfügen der Platten bei Vorhandensein von Kanten und Ecken zusammenhängen. Diese Lösung kann sowohl für Verkleidungen als auch für Böden verwendet werden, beispielsweise um Stufen oder geometrische Volumen zu schaffen.



IL GIUSTO SPESSORE PER TUTTI I TIPI DI OUTDOOR

The right thickness for all kind of outdoor design.
La bonne épaisseur pour tous les types de design extérieur.
Die richtige Stärke für Outdoor-Design.

Tre tipologie di spessori appositamente pensate per sfruttare gli enormi vantaggi progettuali del gres porcellanato in tutti i contesti di progettazione outdoor: dal garden & landscape design, ai percorsi carrabili.

Three different thicknesses specifically conceived to exploit the enormous design advantages of porcelain stoneware within all contexts of outdoor design: from garden & landscape design to driveways.

Trois types d'épaisseurs spécialement conçues pour exploiter les énormes avantages du grès cérame dans tous les contextes extérieurs: de l'aménagement paysager jusqu'à l'aménagement des allées.

Drei verschiedene Stärken, die speziell entwickelt wurden, um die enormen Designvorteile von Feinsteinzeug in allen Bereichen des Outdoor-Designs zu nutzen: vom Garten- und Landschaftsdesign bis zu Zufahrten.

9/10 mm



20 mm



30 mm



9/10mm

RESISTENTE
RESISTANT
RESISTANT
WIDERSTÄNDIG

MONOLITICO
MONOLITHIC
MONOLITHIQUE
MONOLITISCH

INGELIVO
FROST RESISTANT
INGELIFS
FROSTBESTÄNDIG

ANTISCIVOLO
ANTISLIP
ANTIGLISSANT
RUTSCHHEMMEND

20mm

30mm

RESISTENTE
RESISTANT
RESISTANT
WIDERSTÄNDIG

MONOLITICO
MONOLITHIC
MONOLITHIQUE
MONOLITISCH

INGELIVO
FROST RESISTANT
INGELIFS
FROSTBESTÄNDIG

ANTISCIVOLO
ANTISLIP
ANTIGLISSANT
RUTSCHHEMMEND

DRENANTE
DRAINING
DRAINANT
ENTWÄSSERUNG

PRATICO
PRACTICAL
PRATIQUE
PRAKTISCH

FUNZIONALE
FUNCTIONAL
FONCTIONNEL
FUNKTIONAL

30mm

CARRABILITÀ LEGGERA A SECCO
Permette il posizionamento senza ausilio di collanti.

HIGHLY RESISTANT TO LOADS
Allows laying without the use of adhesive.

CARROSSABLE LEGERE ET SECHE.
Permet le positionnement sans l'utilisation d'adhésifs.

BEFAHRBAR BEI LEICHTEM BEANSPRUCH AUF TROCKENVERLEGUNG.
Ermöglicht die Verlegung ohne Verwendung von Klebstoffe.

CARICO DI ROTTURA
2,5 volte superiore al 20 mm.

BREAKING LOAD
2,5 times more than 20 mm.

CHARGE DE RUPTURE.
2,5 fois supérieur au 20 mm

BRUCHLAST
2,5 x höher als bei 20mm Stärke

RESISTENZA ALLA FLESSIONE
Elevata.

BENDING STRENGTH
High.

HAUTE RESISTANCE
au poinçonnement statique

HOHE BIEGEFESTIGKEIT

ANTIVENTO
Il peso elevato garantisce stabilità ed un maggiore ancoraggio al terreno.

WINDPROOF
The heavy weight guarantees stability and a strongest anchorage to the ground.

COUPE-VENT:
Le poids élevé garantit la stabilité et un meilleur ancrage au sol.

WIDERSTÄNDIG GEGEN WIND.
Das hohe Gewicht garantiert Stabilität und eine bessere Verankerung am Boden.

OUTDOOR R11: 9/10 mm - 20 mm - 30 mm

Versatilità e prestazioni per la progettazione in esterna

Versatility and performance for outdoor design.
Polyvalence et performance pour l'aménagement extérieur.
Vielseitigkeit und Leistungen für Outdoor-Design.

Tre tipologie di spessori appositamente pensate per trovare sempre il punto di equilibrio più avanzato tra performance tecniche e stile in tutti i contesti outdoor, anche in piena continuità progettuale con gli ambienti indoor.

Three types of thicknesses expressly conceived to ensure the most advanced combination of technical performance with style for all outdoor contexts, while also maintaining design continuity with indoor environments.

Trois types d'épaisseurs spécialement conçues pour trouver toujours l'équilibre le plus avancé entre performances techniques et style dans tous les contextes extérieurs, même dans la continuité de la conception avec les environnements intérieurs.

Drei Stärken, die speziell entwickelt wurden, um stets das bestmögliche Gleichgewicht zwischen technischer Leistung und Stil in allen Außenbereichen zu entwickeln, zusammen mit einer Designkontinuität der Innenbereiche.



Versatilità e prestazioni per la progettazione in esterna

Versatility and performance for outdoor design.
Polyvalence et performance pour l'aménagement extérieur.
Vielseitigkeit und Leistungen für Outdoor-Design.

POSA SU ERBA
LAYING ON GRASS
POSE SUR HERBE
VERLEGUNG AUF WIESE



POSA SU GHIAIA E SABBIA
LAYING ON GRAVEL AND SAND
POSE SUR SABLE OU SUR GRAVIER
VERLEGUNG AUF KIES-ODER SAND-BETT



POSA TRADIZIONALE
STANDARD LAYING
POSE TRADITIONNELLE
HERKÖMMLICHE VERLEGUNGSART

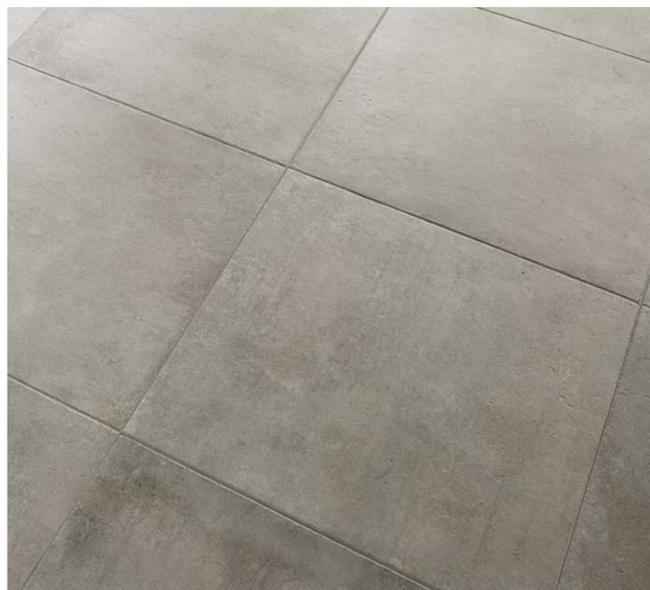

POSA SOPRAELEVATA
RAISED LAYING
POSE SURELEVÉE
VERLEGUNG AUF STELZLAGERN



POSA SOPRAELEVATA
Raised laying
Pose surélevée
Verlegung auf Stelzlagern

Le piastrelle di spessore 20 mm / 30mm si distinguono per l'elevata resistenza allo scivolamento, l'ottima durata nel tempo e l'inalterabilità strutturale in qualsiasi condizione climatica.

Il sistema di pavimentazione sopraelevato prevede l'utilizzo di supporti portanti in polipropilene di tipo fisso, regolabile e autolivellante.

The tiles in 20 mm / 30 mm thickness differs for the very high anti slip resistance, long-lasting and structural unalterability in any climate condition.

The raised paving system is provided with the use of bearing supports in polypropylene fixed or adjustable and auto-levelling.

Les carreaux 20 mm / 30 mm se différencient pour leur résistance élevée au glissement et pour leur excellente durée et inaltérabilité structurale aux situations climatiques.

Le système de carrelage surélevé prévoit l'utilisation de supports fixes en polipropylène, qui peuvent être réglés et nivelés.

Die Fliesen im 20 mm / 30 mm zeichnen sich aus, durch eine hohe Rutschhemmung, eine optimale Haltbarkeit auf die Zeit und einer strukturellen Unveränderlichkeit in jeglichen Klimabedingungen.

Das System des Doppelboden Wire sieht den Gebrauch von fixen, höhenverstellbaren und neigungsausgleichenden Stelzlagern in Polypropylen vor.

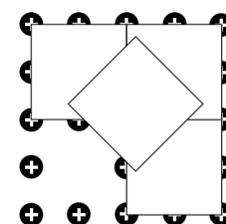

FORMATO / SIZE
120x120 / 48"x48"
90x90 / 35½"x35½"
80x80 / 31½"x31½"
9 PIEDINI (1 centrale)
9 SUPPORTS (1 in the center)

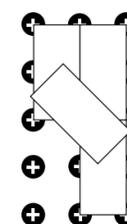

FORMATO / SIZE
60x90 / 24"x35½"
60x120 / 24"x48"
6 PIEDINI
6 SUPPORTS

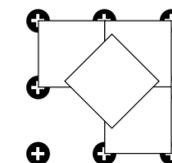

FORMATO / SIZE
60x60 / 24"x24"
4 PIEDINI
4 SUPPORTS

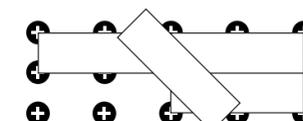

FORMATO / SIZE
40x120 / 16"x48"
6 PIEDINI
6 SUPPORTS

Formato Size Format Format	Spessore Thickness Épaisseur Stärke	Consumo di supporti per m ² Pedestals required per m ² Nombre de plots par m ² Verbrauch an Stützen pro m ²	Consumo di supporti per m ² + 10% Pedestals required per m ² + 10% Nombre de plots par m ² + 10% Verbrauch an Stützen pro m ² + 10%
60x60	20 mm	2,77	3,5
80x80	20 mm	6,2	7
90x90	20 mm	4,95	5,5
60x90	20 mm	3,70	4,5
40x120	20 mm	4,16	5
60x120	20 mm	2,77	3,5
120x120	20 mm	2,77	3,5
60x60	30 mm	2,77	3,5
90x90	30 mm	4,95	5,5

Il sistema permette la realizzazione di piani di posa con altezze variabili comprese tra 25 e 600 mm. Il sistema sopraelevato da esterno, con le fughe aperte, consente un facile deflusso dell'acqua piovana evitando ogni rischio di accumulo della stessa.

La posa sopraelevata permette il passaggio di impianti di cablaggio e tubazioni strutturali attraverso una pratica fruizione dell'intercapedine tra il piano posato e il piano di supporto.

The systems allows the building of laid levels with variable height between 25 and 600 mm. The raised paving system for exterior, with open joints, facilitates an easy draining of rainwater avoiding any risk of build up of the same.

The raised laying allows the passage of wiring and piping systems through a practical fruition of the air space between the laid level and the bottom level.

Le système permet de réaliser des poses surélevées variables comprises entre 25 et 600 mm. Le système surélevé pour extérieurs, consente avec les joints non remplis, l'écoulement facile des eaux en évitant tout risque de rétention.

La pose surélevée permet le passage des cables et des tuyaux à travers l'utilisation pratique de l'espace entre le carrelage et la structure du support.

Dieses System laesst die Realisierung von Bodenbelägen in variablen Hoehen von 25 bis 600 mm zu. Das System Doppelboden im Aussenbereich, mit den offenen Fugen, ermoeoglicht den einfachen Abfluss von Regenwasser und vermeidet somit jedes Risiko von Ansammlungen.

Die Verlegung im Doppelboden ermoeoglicht einen Durchgang fuer elektrische und hydraulische Leitungen ueber einen praktischen, komfortablen Hohlraum zwischen verlegter Ebene und Traegeebene.



*** piedino regolabile 25-30

600101



*** piedino regolabile 30-37

600102



*** piedino regolabile 37-50

600103



*** piedino regolabile 50-75

600104



*** piedino regolabile 75-125

600105



*** piedino regolabile 125-225

600106



*** prolunga piedini h 100 mm

600107



chiave di regolazione

600108

*** Vendita a scatola completa. - Full box sale. - Vente à la boîte complète. - Volle Kartons.

PEZZI SPECIALI PER ESTERNO

Special pieces for outdoor
Pièces spéciales pour extérieur
Formteile für Aussenbereich

PEZZI SPECIALI PER PISCINA

Special pieces for swimming pool
Pièces spéciales pour piscine
Formteile für Schwimmbad



PEZZI SPECIALI PER ESTERNO

Special pieces for outdoor
Pièces spéciales pour extérieur
Formteile für Aussenbereich

Elemento a L



Gradone grip



Gradone

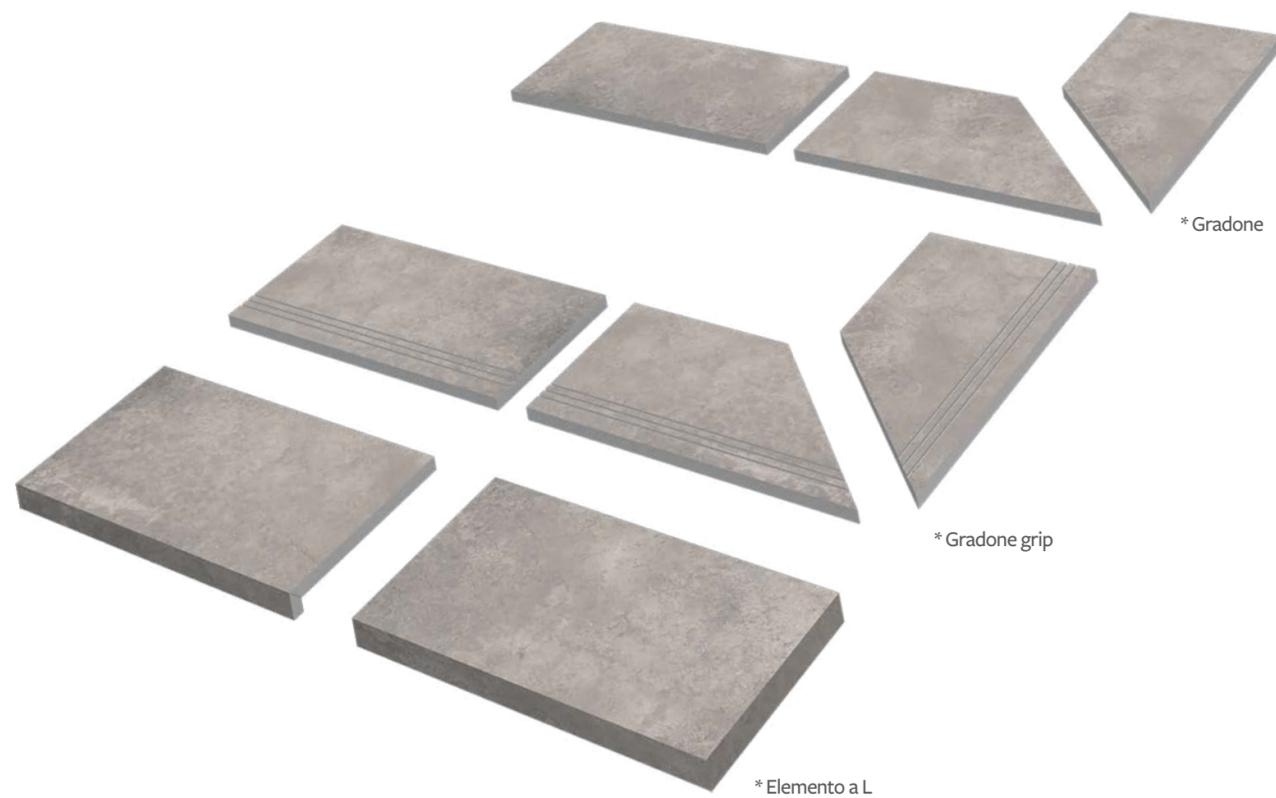
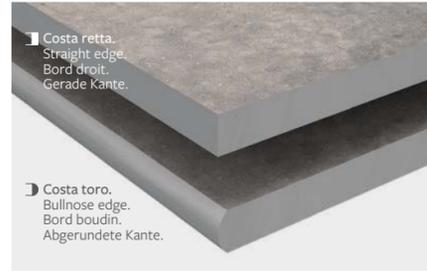

PEZZI SPECIALI PER PISCINA

Special pieces for swimming pool
Pièces spéciales pour piscine
Formteile für Schwimmbad

Gradone svasato bordo piscina



Gradone grip bordo piscina



Gradone bordo piscina

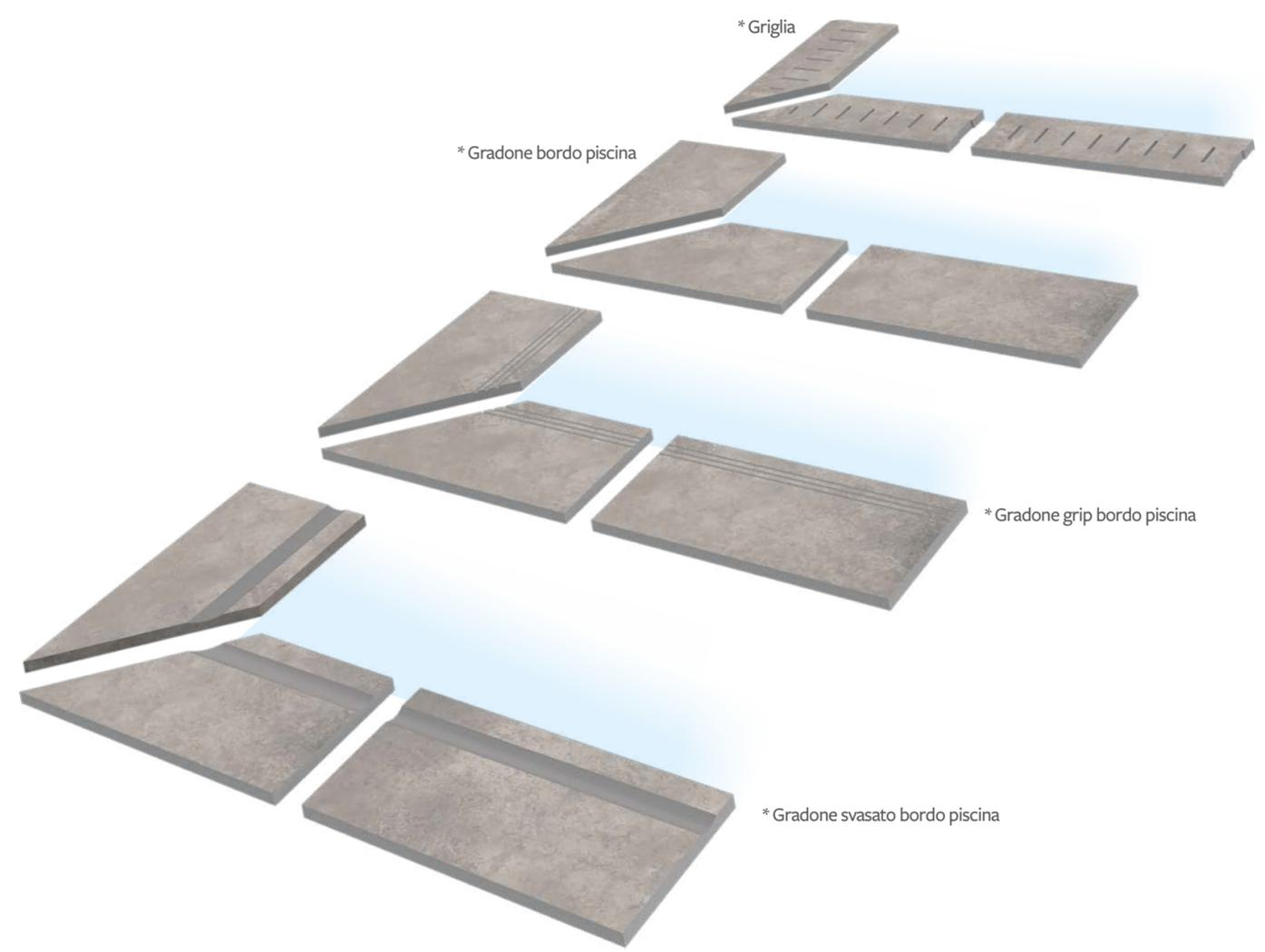

* I tempi di consegna di tutti i pezzi speciali mostrati in queste pagine sono di 30 giorni dalla data dell'ordine.
Delivery time for all the special pieces shown on these pages are generally 30 days from order date.
La livraison de toutes les pièces spéciales présentés dans les pages du catalogue sont disponible 30 jours à compter de la date de commande.
Der Liefertermin fuer die Spezialteile, die in dieser Seite aufgefuehrt sind, belaeuft sich auf 30 Tage nach Auftragseingang.

Spessore · Thickness · Epaisseur · Stärke - 20 mm R11

Gres porcellanato colorato in massa. Full-body coloured porcelain stoneware. Grès cérame coloré dans la masse. In der Masse gefärbtes Feinsteinzeug.

OUTDOOR

TABELLA RIEPILOGATIVA
Summary table
Tableau récapitulatif
Zusammenfassenden Tabelle

		* Gradone			* Ang. Gradone - SX			* Ang. Gradone - DX			* Gradone grip			* Ang. Gradone grip - SX			* Ang. Gradone grip - DX						
		40x120 16"x48"	30x120 12"x48"	30x90 12"x35½"	30x60 12"x24"	40x120 16"x48"	30x120 12"x48"	30x90 12"x35½"	30x60 12"x24"	40x120 16"x48"	30x120 12"x48"	30x90 12"x35½"	30x60 12"x24"	40x120 16"x48"	30x120 12"x48"	30x90 12"x35½"	30x60 12"x24"	40x120 16"x48"	30x120 12"x48"	30x90 12"x35½"	30x60 12"x24"		
APOSEO	WHITE R11	☐ Nat. Ret.	■ 113627 ▶ 113663	■ 113615 ▶ 113651	■ 113603 ▶ 113639	■ 113635 ▶ 113671	■ 113623 ▶ 113659	■ 113611 ▶ 113647	■ 113631 ▶ 113667	■ 113619 ▶ 113655	■ 113607 ▶ 113643	■ 113699 ▶ 113735	■ 113687 ▶ 113723	■ 113675 ▶ 113711	■ 113707 ▶ 113743	■ 113695 ▶ 113731	■ 113683 ▶ 113719	■ 113703 ▶ 113739	■ 113691 ▶ 113727	■ 113679 ▶ 113715			
	GREY R11	☐ Nat. Ret.	■ 113625 ▶ 113661	■ 113613 ▶ 113649	■ 113601 ▶ 113637	■ 113633 ▶ 113669	■ 113621 ▶ 113657	■ 113609 ▶ 113645	■ 113629 ▶ 113665	■ 113617 ▶ 113653	■ 113605 ▶ 113641	■ 113697 ▶ 113733	■ 113685 ▶ 113721	■ 113673 ▶ 113709	■ 113705 ▶ 113741	■ 113693 ▶ 113729	■ 113681 ▶ 113717	■ 113701 ▶ 113737	■ 113689 ▶ 113725	■ 113677 ▶ 113713			
	ANTHRACITE R11	☐ Nat. Ret.	■ 113626 ▶ 113662	■ 113614 ▶ 113650	■ 113602 ▶ 113638	■ 113634 ▶ 113670	■ 113622 ▶ 113658	■ 113610 ▶ 113646	■ 113630 ▶ 113666	■ 113618 ▶ 113654	■ 113606 ▶ 113642	■ 113698 ▶ 113734	■ 113686 ▶ 113722	■ 113674 ▶ 113710	■ 113706 ▶ 113742	■ 113694 ▶ 113730	■ 113682 ▶ 113718	■ 113702 ▶ 113738	■ 113690 ▶ 113726	■ 113678 ▶ 113714			
	BLACK R11	☐ Nat. Ret.	■ 113624 ▶ 113660	■ 113612 ▶ 113648	■ 113600 ▶ 113636	■ 113632 ▶ 113668	■ 113620 ▶ 113656	■ 113608 ▶ 113644	■ 113628 ▶ 113664	■ 113616 ▶ 113652	■ 113604 ▶ 113640	■ 113696 ▶ 113732	■ 113684 ▶ 113720	■ 113672 ▶ 113708	■ 113704 ▶ 113740	■ 113692 ▶ 113728	■ 113680 ▶ 113716	■ 113700 ▶ 113736	■ 113688 ▶ 113724	■ 113676 ▶ 113712			
AURUM STONE	PURE R11	☐ Nat. Ret.		■ 102110 ▶ 102111		■ 102112 ▶ 102113		■ 102114 ▶ 102115		■ 102116 ▶ 102117		■ 102118 ▶ 102119		■ 102120 ▶ 102121									
CONCRETA	GRIGIO CHIARO R11	☐ Nat. Ret.	■ 119370 ▶ 119415	■ 119355 ▶ 119400	■ 119340 ▶ 119385	■ 119380 ▶ 119425	■ 119365 ▶ 119410	■ 119350 ▶ 119395	■ 119375 ▶ 119420	■ 119360 ▶ 119405	■ 119345 ▶ 119390	■ 119460 ▶ 119505	■ 119445 ▶ 119490	■ 119430 ▶ 119475	■ 119470 ▶ 119515	■ 119455 ▶ 119500	■ 119440 ▶ 119485	■ 119465 ▶ 119510	■ 119450 ▶ 119495	■ 119435 ▶ 119480			
	GRIGIO SCURO R11	☐ Nat. Ret.	■ 119371 ▶ 119416	■ 119356 ▶ 119401	■ 119341 ▶ 119386	■ 119381 ▶ 119426	■ 119366 ▶ 119411	■ 119351 ▶ 119396	■ 119376 ▶ 119421	■ 119361 ▶ 119406	■ 119346 ▶ 119391	■ 119461 ▶ 119506	■ 119446 ▶ 119491	■ 119431 ▶ 119476	■ 119471 ▶ 119516	■ 119456 ▶ 119501	■ 119441 ▶ 119486	■ 119466 ▶ 119511	■ 119451 ▶ 119496	■ 119436 ▶ 119481			
	TERRA R11	☐ Nat. Ret.	■ 119372 ▶ 119417	■ 119357 ▶ 119402	■ 119342 ▶ 119387	■ 119382 ▶ 119427	■ 119367 ▶ 119412	■ 119352 ▶ 119397	■ 119377 ▶ 119422	■ 119362 ▶ 119407	■ 119347 ▶ 119392	■ 119462 ▶ 119507	■ 119447 ▶ 119492	■ 119432 ▶ 119477	■ 119472 ▶ 119517	■ 119457 ▶ 119502	■ 119442 ▶ 119487	■ 119467 ▶ 119512	■ 119452 ▶ 119497	■ 119437 ▶ 119482			
DEEP BLUE	GRIGIO R11	☐ Nat. Ret.	■ 120120 ▶ 120121	■ 120127 ▶ 120128	■ 120134 ▶ 120135	■ 120141 ▶ 120142	■ 120148 ▶ 120149	■ 120155 ▶ 120156	■ 120162 ▶ 120163	■ 120169 ▶ 120170	■ 120176 ▶ 120177	■ 120183 ▶ 120184	■ 120190 ▶ 120191	■ 120197 ▶ 120198	■ 120204 ▶ 120205	■ 120211 ▶ 120212	■ 120218 ▶ 120219	■ 120225 ▶ 120226	■ 120232 ▶ 120233	■ 120239 ▶ 120240			
	ANTRACITE R11	☐ Nat. Ret.	■ 120122 ▶ 120123	■ 120129 ▶ 120130	■ 120136 ▶ 120137	■ 120143 ▶ 120144	■ 120150 ▶ 120151	■ 120157 ▶ 120158	■ 120164 ▶ 120165	■ 120171 ▶ 120172	■ 120178 ▶ 120179	■ 120185 ▶ 120186	■ 120192 ▶ 120193	■ 120199 ▶ 120200	■ 120206 ▶ 120207	■ 120213 ▶ 120214	■ 120220 ▶ 120221	■ 120227 ▶ 120228	■ 120234 ▶ 120235	■ 120241 ▶ 120242			
EVOQUE	KORINA R11	☐ Nat. Ret.	■ 105270 ▶ 105271			■ 105280 ▶ 105281			■ 105290 ▶ 105291			■ 105300 ▶ 105301			■ 105310 ▶ 105311			■ 105320 ▶ 105321					
	ROVERE R11	☐ Nat. Ret.	■ 105272 ▶ 105273			■ 105282 ▶ 105283			■ 105292 ▶ 105293			■ 105302 ▶ 105303			■ 105312 ▶ 105313			■ 105322 ▶ 105323					
	DOUSSIE R11	☐ Nat. Ret.	■ 105274 ▶ 105275			■ 105284 ▶ 105285			■ 105294 ▶ 105295			■ 105304 ▶ 105305			■ 105314 ▶ 105315			■ 105324 ▶ 105325					
	DOUGLAS R11	☐ Nat. Ret.	■ 105276 ▶ 105277			■ 105286 ▶ 105287			■ 105296 ▶ 105297			■ 105306 ▶ 105307			■ 105316 ▶ 105317			■ 105326 ▶ 105327					
	BAHIA R11	☐ Nat. Ret.	■ 105278 ▶ 105279			■ 105288 ▶ 105289			■ 105298 ▶ 105299			■ 105308 ▶ 105309			■ 105318 ▶ 105319			■ 105328 ▶ 105329					
			1	1	1	1	1	1	1	1	1	1	1	1	1	1	1	1	1	1	1		
			m² x																				
			Kg x	21,5	18	13,5	9	21,5	14	10,5	7	21,5	18	13,5	9	21,5	14	10,5	7	21,5	14	10,5	7

I pesi riportati in tabella sono indicativi e potrebbero essere soggetti a leggere variazioni.
The weights stated in the chart may undergo slight changes for production reasons.
Les poids indiqués dans le tableau peuvent subir de légères variations pour des raisons de production.
Die in der Tabelle angegebenen Gewichte können aus Produktionsgründen geringfügigen Abweichungen unterliegen.

Non si garantisce l'abbinabilità tra fondi di spessori diversi e tra fondo e pezzo speciale.
It is not guaranteed that background tiles with different thicknesses can be used together, nor is it guaranteed for background tiles and trims.
Nous ne garantissons pas la possibilité de combiner des carrelages de sol de différentes épaisseurs et un carrelage de sol avec une pièce spéciale.
Die Kombinierbarkeit von Fliesen unterschiedlicher Stärke sowie zwischen Fliese und Formteil kann nicht garantiert werden.

* A disposizione solo su richiesta. Tempi di consegna 30 gg.
Available upon request only. Delivery terms: 30 days.
Disponible seulement sur requête. Délais de livraison: 30 jours.
Verfügbar auf Anfrage. Lieferzeit: 30 Tage.

☐ Naturale e rettificato. Natural rectified. Naturel et rectifié. Natur Oberfläche und rektifiziert.
■ Costa retta. Straight edge. Bord droit. Gerade Kante.
▶ Costa toro. Bullnose edge. Bord boudin. Abgerundete Kante.

Spessore · Thickness · Epaisseur · Stärke - 20 mm R11

Gres porcellanato colorato in massa. Full-body coloured porcelain stoneware. Grès cérame coloré dans la masse. In der Masse gefärbtes Feinsteinzeug.

OUTDOOR

TABELLA RIEPILOGATIVA
Summary table
Tableau récapitulatif
Zusammenfassenden Tabelle

		* Gradone			* Ang. Gradone - SX			* Ang. Gradone - DX			* Gradone grip			* Ang. Gradone grip - SX			* Ang. Gradone grip - DX											
		40x120 16"x48"	30x120 12"x48"	30x90 12"x35½"	30x60 12"x24"	40x120 16"x48"	30x120 12"x48"	30x90 12"x35½"	30x60 12"x24"	40x120 16"x48"	30x120 12"x48"	30x90 12"x35½"	30x60 12"x24"	40x120 16"x48"	30x120 12"x48"	30x90 12"x35½"	30x60 12"x24"	40x120 16"x48"	30x120 12"x48"	30x90 12"x35½"	30x60 12"x24"							
ILCOTTAGINA	NATURAL R11	<input type="checkbox"/> Nat. Ret.	■ 116368 ▶ 116404	■ 116350 ▶ 116386	■ 116380 ▶ 116416	■ 116362 ▶ 116398	■ 116374 ▶ 116410	■ 116356 ▶ 116392	■ 116440 ▶ 116476	■ 116422 ▶ 116458	■ 116452 ▶ 116488	■ 116434 ▶ 116470	■ 116446 ▶ 116482	■ 116428 ▶ 116464														
	CLEAR R11	<input type="checkbox"/> Nat. Ret.	■ 116369 ▶ 116405	■ 116351 ▶ 116387	■ 116381 ▶ 116417	■ 116363 ▶ 116399	■ 116375 ▶ 116411	■ 116357 ▶ 116393	■ 116441 ▶ 116477	■ 116423 ▶ 116459	■ 116453 ▶ 116489	■ 116435 ▶ 116471	■ 116447 ▶ 116483	■ 116429 ▶ 116465														
	RED R11	<input type="checkbox"/> Nat. Ret.	■ 116370 ▶ 116406	■ 116352 ▶ 116388	■ 116382 ▶ 116418	■ 116364 ▶ 116400	■ 116376 ▶ 116412	■ 116358 ▶ 116394	■ 116442 ▶ 116478	■ 116424 ▶ 116460	■ 116454 ▶ 116490	■ 116436 ▶ 116472	■ 116448 ▶ 116484	■ 116430 ▶ 116466														
	GREY R11	<input type="checkbox"/> Nat. Ret.	■ 116371 ▶ 116407	■ 116353 ▶ 116389	■ 116383 ▶ 116419	■ 116365 ▶ 116401	■ 116377 ▶ 116413	■ 116359 ▶ 116395	■ 116443 ▶ 116479	■ 116425 ▶ 116461	■ 116455 ▶ 116491	■ 116437 ▶ 116473	■ 116449 ▶ 116485	■ 116431 ▶ 116467														
MEDITERRANEA	DOR R11	<input type="checkbox"/> Nat. Ret.	■ 128501 ▶ 128502	■ 128503 ▶ 128504	■ 128505 ▶ 128506	■ 128507 ▶ 128508	■ 128521 ▶ 128522	■ 128523 ▶ 128524	■ 128525 ▶ 128526	■ 128527 ▶ 128528	■ 128511 ▶ 128512	■ 128513 ▶ 128514	■ 128515 ▶ 128516	■ 128517 ▶ 128518	■ 128531 ▶ 128532	■ 128533 ▶ 128534	■ 128535 ▶ 128536	■ 128537 ▶ 128538	■ 128551 ▶ 128552	■ 128553 ▶ 128554	■ 128555 ▶ 128556	■ 128557 ▶ 128558	■ 128541 ▶ 128542	■ 128543 ▶ 128544	■ 128545 ▶ 128546	■ 128547 ▶ 128548		
	BYBLOS R11	<input type="checkbox"/> Nat. Ret.	■ 128503 ▶ 128504	■ 128505 ▶ 128506	■ 128507 ▶ 128508	■ 128509 ▶ 128510	■ 128521 ▶ 128522	■ 128523 ▶ 128524	■ 128525 ▶ 128526	■ 128527 ▶ 128528	■ 128511 ▶ 128512	■ 128513 ▶ 128514	■ 128515 ▶ 128516	■ 128517 ▶ 128518	■ 128531 ▶ 128532	■ 128533 ▶ 128534	■ 128535 ▶ 128536	■ 128537 ▶ 128538	■ 128551 ▶ 128552	■ 128553 ▶ 128554	■ 128555 ▶ 128556	■ 128557 ▶ 128558	■ 128541 ▶ 128542	■ 128543 ▶ 128544	■ 128545 ▶ 128546	■ 128547 ▶ 128548		
	ERICE R11	<input type="checkbox"/> Nat. Ret.	■ 128505 ▶ 128506	■ 128507 ▶ 128508	■ 128509 ▶ 128510	■ 128511 ▶ 128512	■ 128521 ▶ 128522	■ 128523 ▶ 128524	■ 128525 ▶ 128526	■ 128527 ▶ 128528	■ 128511 ▶ 128512	■ 128513 ▶ 128514	■ 128515 ▶ 128516	■ 128517 ▶ 128518	■ 128531 ▶ 128532	■ 128533 ▶ 128534	■ 128535 ▶ 128536	■ 128537 ▶ 128538	■ 128551 ▶ 128552	■ 128553 ▶ 128554	■ 128555 ▶ 128556	■ 128557 ▶ 128558	■ 128541 ▶ 128542	■ 128543 ▶ 128544	■ 128545 ▶ 128546	■ 128547 ▶ 128548		
	MENFI R11	<input type="checkbox"/> Nat. Ret.	■ 128507 ▶ 128508	■ 128509 ▶ 128510	■ 128511 ▶ 128512	■ 128513 ▶ 128514	■ 128521 ▶ 128522	■ 128523 ▶ 128524	■ 128525 ▶ 128526	■ 128527 ▶ 128528	■ 128511 ▶ 128512	■ 128513 ▶ 128514	■ 128515 ▶ 128516	■ 128517 ▶ 128518	■ 128531 ▶ 128532	■ 128533 ▶ 128534	■ 128535 ▶ 128536	■ 128537 ▶ 128538	■ 128551 ▶ 128552	■ 128553 ▶ 128554	■ 128555 ▶ 128556	■ 128557 ▶ 128558	■ 128541 ▶ 128542	■ 128543 ▶ 128544	■ 128545 ▶ 128546	■ 128547 ▶ 128548		
METAL	IRON R11	<input type="checkbox"/> Nat. Ret.	■ 124502 ▶ 124503	■ 124504 ▶ 124505	■ 124506 ▶ 124507	■ 124508 ▶ 124509	■ 124522 ▶ 124523	■ 124524 ▶ 124525	■ 124526 ▶ 124527	■ 124528 ▶ 124529	■ 124512 ▶ 124513	■ 124514 ▶ 124515	■ 124516 ▶ 124517	■ 124518 ▶ 124519	■ 124532 ▶ 124533	■ 124534 ▶ 124535	■ 124536 ▶ 124537	■ 124538 ▶ 124539	■ 124552 ▶ 124553	■ 124554 ▶ 124555	■ 124556 ▶ 124557	■ 124558 ▶ 124559	■ 124542 ▶ 124543	■ 124544 ▶ 124545	■ 124546 ▶ 124547	■ 124548 ▶ 124549		
	CORTEN R11	<input type="checkbox"/> Nat. Ret.	■ 124504 ▶ 124505	■ 124506 ▶ 124507	■ 124508 ▶ 124509	■ 124510 ▶ 124511	■ 124522 ▶ 124523	■ 124524 ▶ 124525	■ 124526 ▶ 124527	■ 124528 ▶ 124529	■ 124512 ▶ 124513	■ 124514 ▶ 124515	■ 124516 ▶ 124517	■ 124518 ▶ 124519	■ 124532 ▶ 124533	■ 124534 ▶ 124535	■ 124536 ▶ 124537	■ 124538 ▶ 124539	■ 124552 ▶ 124553	■ 124554 ▶ 124555	■ 124556 ▶ 124557	■ 124558 ▶ 124559	■ 124542 ▶ 124543	■ 124544 ▶ 124545	■ 124546 ▶ 124547	■ 124548 ▶ 124549		
	OXIDE R11	<input type="checkbox"/> Nat. Ret.	■ 124506 ▶ 124507	■ 124508 ▶ 124509	■ 124510 ▶ 124511	■ 124512 ▶ 124513	■ 124522 ▶ 124523	■ 124524 ▶ 124525	■ 124526 ▶ 124527	■ 124528 ▶ 124529	■ 124512 ▶ 124513	■ 124514 ▶ 124515	■ 124516 ▶ 124517	■ 124518 ▶ 124519	■ 124532 ▶ 124533	■ 124534 ▶ 124535	■ 124536 ▶ 124537	■ 124538 ▶ 124539	■ 124552 ▶ 124553	■ 124554 ▶ 124555	■ 124556 ▶ 124557	■ 124558 ▶ 124559	■ 124542 ▶ 124543	■ 124544 ▶ 124545	■ 124546 ▶ 124547	■ 124548 ▶ 124549		
	TITANIUM R11	<input type="checkbox"/> Nat. Ret.	■ 124508 ▶ 124509	■ 124510 ▶ 124511	■ 124512 ▶ 124513	■ 124514 ▶ 124515	■ 124522 ▶ 124523	■ 124524 ▶ 124525	■ 124526 ▶ 124527	■ 124528 ▶ 124529	■ 124512 ▶ 124513	■ 124514 ▶ 124515	■ 124516 ▶ 124517	■ 124518 ▶ 124519	■ 124532 ▶ 124533	■ 124534 ▶ 124535	■ 124536 ▶ 124537	■ 124538 ▶ 124539	■ 124552 ▶ 124553	■ 124554 ▶ 124555	■ 124556 ▶ 124557	■ 124558 ▶ 124559	■ 124542 ▶ 124543	■ 124544 ▶ 124545	■ 124546 ▶ 124547	■ 124548 ▶ 124549		
NAMUR	BLANCHE R11	<input type="checkbox"/> Nat. Ret.	■ 136501 ▶ 136502	■ 136503 ▶ 136504	■ 136505 ▶ 136506	■ 136507 ▶ 136508	■ 136531 ▶ 136532	■ 136546 ▶ 136547	■ 136533 ▶ 136534	■ 136548 ▶ 136549	■ 136535 ▶ 136536	■ 136546 ▶ 136547	■ 136537 ▶ 136538	■ 136548 ▶ 136549	■ 136561 ▶ 136562	■ 136576 ▶ 136577	■ 136563 ▶ 136564	■ 136578 ▶ 136579	■ 136565 ▶ 136566	■ 136576 ▶ 136577	■ 136567 ▶ 136568	■ 136578 ▶ 136579	■ 136569 ▶ 136570	■ 136580 ▶ 136581	■ 136582 ▶ 136583	■ 136584 ▶ 136585	■ 136586 ▶ 136587	
	CENDRE R11	<input type="checkbox"/> Nat. Ret.	■ 136503 ▶ 136504	■ 136505 ▶ 136506	■ 136507 ▶ 136508	■ 136509 ▶ 136510	■ 136531 ▶ 136532	■ 136546 ▶ 136547	■ 136533 ▶ 136534	■ 136548 ▶ 136549	■ 136535 ▶ 136536	■ 136546 ▶ 136547	■ 136537 ▶ 136538	■ 136548 ▶ 136549	■ 136561 ▶ 136562	■ 136576 ▶ 136577	■ 136563 ▶ 136564	■ 136578 ▶ 136579	■ 136565 ▶ 136566	■ 136576 ▶ 136577	■ 136567 ▶ 136568	■ 136578 ▶ 136579	■ 136569 ▶ 136570	■ 136580 ▶ 136581	■ 136582 ▶ 136583	■ 136584 ▶ 136585	■ 136586 ▶ 136587	
	FONCÉ R11	<input type="checkbox"/> Nat. Ret.	■ 136505 ▶ 136506	■ 136507 ▶ 136508	■ 136509 ▶ 136510	■ 136511 ▶ 136512	■ 136531 ▶ 136532	■ 136546 ▶ 136547	■ 136533 ▶ 136534	■ 136548 ▶ 136549	■ 136535 ▶ 136536	■ 136546 ▶ 136547	■ 136537 ▶ 136538	■ 136548 ▶ 136549	■ 136561 ▶ 136562	■ 136576 ▶ 136577	■ 136563 ▶ 136564	■ 136578 ▶ 136579	■ 136565 ▶ 136566	■ 136576 ▶ 136577	■ 136567 ▶ 136568	■ 136578 ▶ 136579	■ 136569 ▶ 136570	■ 136580 ▶ 136581	■ 136582 ▶ 136583	■ 136584 ▶ 136585	■ 136586 ▶ 136587	
		1	1	1	1	1	1	1	1	1	1	1	1	1	1	1	1	1	1	1	1	1	1	1	1	1	1	
		18	13,5	9	14	10,5	7	14	10,5	7	18	13,5	9	14	10,5	7	14	10,5	7	14	10,5	7	14	10,5	7	14	10,5	7

I pesi riportati in tabella sono indicativi e potrebbero essere soggetti a leggere variazioni.
The weights stated in the chart may undergo slight changes for production reasons.
Les poids indiqués dans le tableau peuvent subir de légères variations pour des raisons de production.
Die in der Tabelle angegebenen Gewichte können aus Produktionsgründen geringfügigen Abweichungen unterliegen.

Non si garantisce l'abbinabilità tra fondi di spessori diversi e tra fondo e pezzo speciale.
It is not guaranteed that background tiles with different thicknesses can be used together, nor is it guaranteed for background tiles and trims.
Nous ne garantissons pas la possibilité de combiner des carrelages de sol de différentes épaisseurs et un carrelage de sol avec une pièce spéciale.
Die Kombinierbarkeit von Fliesen unterschiedlicher Stärke sowie zwischen Fliese und Formteil kann nicht garantiert werden.

* A disposizione solo su richiesta. Tempi di consegna 30 gg.
Available upon request only. Delivery terms: 30 days.
Disponible seulement sur requête. Délais de livraison: 30 jours.
Verfügbar auf Anfrage. Lieferzeit: 30 Tage.

Naturale e rettificato. Natural rectified. Naturel et rectifié. Natur Oberfläche und rektifiziert.
 Costa retta. Straight edge. Bord droit. Gerade Kante.
 Costa toro. Bullnose edge. Bord boudin. Abgerundete Kante.

PEZZI SPECIALI PER ESTERNO

SPECIAL PIECES FOR OUTDOOR · PIÈCES SPECIALES POUR EXTERIEUR · FORMTEILE FÜR AUSSENBEREICH

R11
A+B+C

Spessore · Thickness · Épaisseur · Stärke - 20 mm R11

Gres porcellanato colorato in massa. Full-body coloured porcelain stoneware. Grès cérame coloré dans la masse. In der Masse gefärbtes Feinsteinzeug.

OUTDOOR

TABELLA RIEPILOGATIVA
Summary table
Tableau récapitulatif
Zusammenfassende Tabelle

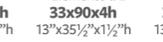
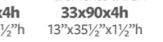
												
			33x120x4h 13"x48"x1 1/2"h	* Elemento a L 33x90x4h 13"x35 1/2"x1 1/2"h	33x60x4h 13"x24"x1 1/2"h	33x120x4h 13"x48"x1 1/2"h	* Elemento a L SX 33x90x4h 13"x35 1/2"x1 1/2"h	33x60x4h 13"x24"x1 1/2"h	33x120x4h 13"x48"x1 1/2"h	* Elemento a L DX 33x90x4h 13"x35 1/2"x1 1/2"h	33x60x4h 13"x24"x1 1/2"h	
APOGEO		WHITE R11	<input type="checkbox"/> Nat. Ret.	113579	113567	113555	113587	113575	113563	113583	113571	113559
		GREY R11	<input type="checkbox"/> Nat. Ret.	113577	113565	113553	113585	113573	113561	113581	113569	113557
		ANTHRACITE R11	<input type="checkbox"/> Nat. Ret.	113578	113566	113554	113586	113574	113562	113582	113570	113558
		BLACK R11	<input type="checkbox"/> Nat. Ret.	113576	113564	113552	113584	113572	113560	113580	113568	113556
AURUM STONE		PURE R11	<input type="checkbox"/> Nat. Ret.		102100				102101			102102
		GRIGIO CHIARO R11	<input type="checkbox"/> Nat. Ret.	119310	119295	119280	119320	119305	119290	119315	119300	119285
		GRIGIO SCURO R11	<input type="checkbox"/> Nat. Ret.	119311	119296	119281	119321	119306	119291	119316	119301	119286
CONCRETA		TERRA R11	<input type="checkbox"/> Nat. Ret.	119312	119297	119282	119322	119307	119292	119317	119302	119287
		GRIGIO R11	<input type="checkbox"/> Nat. Ret.	120100	120102	120104	120106	120108	120110	120112	120114	120116
		ANTRACITE R11	<input type="checkbox"/> Nat. Ret.	120101	120103	120105	120107	120109	120111	120113	120115	120117
DEEP BLUE		KORINA R11	<input type="checkbox"/> Nat. Ret.	105250			105255			105260		
		ROVERE R11	<input type="checkbox"/> Nat. Ret.	105251			105256			105261		
		DOUSSIE R11	<input type="checkbox"/> Nat. Ret.	105252			105257			105262		
EVOQUE		DOUGLAS R11	<input type="checkbox"/> Nat. Ret.	105253			105258			105263		
		BAHIA R11	<input type="checkbox"/> Nat. Ret.	105254			105259			105264		
				1	2	2	1	1	1	1	1	1
				19	28,2	18,5	19	14,1	9,25	19	14,1	9,25
												

I pesi riportati in tabella sono indicativi e potrebbero essere soggetti a leggere variazioni.
The weights stated in the chart may undergo slight changes for production reasons.
Les poids indiqués dans le tableau peuvent subir de légères variations pour des raisons de production.
Die in der Tabelle angegebenen Gewichte können aus Produktionsgründen geringfügigen Abweichungen unterliegen.

Non si garantisce l'abbinabilità tra fondi di spessori diversi e tra fondo e pezzo speciale.
It is not guaranteed that background tiles with different thicknesses can be used together, nor is it guaranteed for background tiles and trims.
Nous ne garantissons pas la possibilité de combiner des carrelages de sol de différentes épaisseurs et un carrelage de sol avec une pièce spéciale.
Die Kombinierbarkeit von Fliesen unterschiedlicher Stärke sowie zwischen Fliese und Formteil kann nicht garantiert werden.

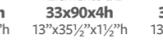
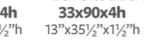
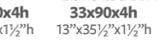
												
			33x120x4h 13"x48"x1 1/2"h	* Elemento a L 33x90x4h 13"x35 1/2"x1 1/2"h	33x60x4h 13"x24"x1 1/2"h	33x120x4h 13"x48"x1 1/2"h	* Elemento a L SX 33x90x4h 13"x35 1/2"x1 1/2"h	33x60x4h 13"x24"x1 1/2"h	33x120x4h 13"x48"x1 1/2"h	* Elemento a L DX 33x90x4h 13"x35 1/2"x1 1/2"h	33x60x4h 13"x24"x1 1/2"h	
ILCOTTAGINA		NATURAL R11	<input type="checkbox"/> Nat. Ret.	116314	116296		116326	116308		116320	116302	
		CLEAR R11	<input type="checkbox"/> Nat. Ret.	116315	116297		116327	116309		116321	116303	
		RED R11	<input type="checkbox"/> Nat. Ret.	116316	116298		116328	116310		116322	116304	
		GREY R11	<input type="checkbox"/> Nat. Ret.	116317	116299		116329	116311		116323	116305	
MEDITERRANEA		DOR R11	<input type="checkbox"/> Nat. Ret.	128681			128701			128691		
		BYBLOS R11	<input type="checkbox"/> Nat. Ret.	128682			128702			128692		
		ERICE R11	<input type="checkbox"/> Nat. Ret.	128683			128703			128693		
METAL		MENFI R11	<input type="checkbox"/> Nat. Ret.	128684			128704			128694		
		IRON R11	<input type="checkbox"/> Nat. Ret.	124672			124692			124682		
		CORTEN R11	<input type="checkbox"/> Nat. Ret.	124673			124693			124683		
NAMUR		OXIDE R11	<input type="checkbox"/> Nat. Ret.	124674			124694			124684		
		TITANIUM R11	<input type="checkbox"/> Nat. Ret.	124675			124695			124685		
		BLANCHE R11	<input type="checkbox"/> Nat. Ret.	136513	136528		136543	136558		136573	136588	
	CENDRE R11	<input type="checkbox"/> Nat. Ret.	136514	136529		136544	136559		136574	136589		
	FONCÉ R11	<input type="checkbox"/> Nat. Ret.	136515	136530		136545	136560		136575	136590		
			1	2	2	1	1	1	1	1	1	
				19	28,2	18,5	19	14,1	9,25	19	14,1	9,25
												

* A disposizione solo su richiesta. Tempi di consegna 30 gg.
Available upon request only. Delivery terms: 30 days.
Disponible seulement sur requête. Délais de livraison: 30 jours.
Verfügbar auf Anfrage. Lieferzeit: 30 Tage.

Naturale e rettificato.
Natural rectified.
Naturel et rectifié.
Natur Oberfläche und rektifiziert.

Costa retta.
Straight edge.
Bord droit.
Gerade Kante.

Costa toro.
Bullnose edge.
Bord boudin.
Abgerundete Kante.

Spessore · Thickness · Épaisseur · Stärke - 20 mm R11

Gres porcellanato colorato in massa. Full-body coloured porcelain stoneware. Grès cérame coloré dans la masse. In der Masse gefärbtes Feinsteinzeug.

OUTDOOR

TABELLA RIEPILOGATIVA
Summary table
Tableau récapitulatif
Zusammenfassenden Tabelle

			* Elemento a L				* Elemento a L SX				* Elemento a L DX			
			33x120x4h 13"x48"x1½"h	33x90x4h 13"x35½"x1½"h	33x80x4h 13"x31½"x1½"h	33x60x4h 13"x24"x1½"h	33x120x4h 13"x48"x1½"h	33x90x4h 13"x35½"x1½"h	33x80x4h 13"x31½"x1½"h	33x60x4h 13"x24"x1½"h	33x120x4h 13"x48"x1½"h	33x90x4h 13"x35½"x1½"h	33x80x4h 13"x31½"x1½"h	33x60x4h 13"x24"x1½"h
PIETRA D'ORVIETO	 BIANCO R11	<input type="checkbox"/> Nat. Ret.	138648		138792		138652		138796		138656		138800	
	 BEIGE R11	<input type="checkbox"/> Nat. Ret.	138649		138793		138653		138797		138657		138801	
	 SABBIA R11	<input type="checkbox"/> Nat. Ret.	138650		138794		138654		138798		138658		138802	
	 CENERE R11	<input type="checkbox"/> Nat. Ret.	138651		138795		138655		138799		138659		138803	
PIETRA REGALE	 ELVA R11	<input type="checkbox"/> Nat. Ret.	117284	117309		117334	117293	117319		117344		117298	117324	117349
	 RIVOLI R11	<input type="checkbox"/> Nat. Ret.	117283	117308		117333	117292	117318		117343		117297	117323	117348
	 OSTANA R11	<input type="checkbox"/> Nat. Ret.	117282	117307		117332	117291	117317		117342		117296	117322	117347
	 CHIANALE R11	<input type="checkbox"/> Nat. Ret.	117280	117305		117330	117289	117315		117340		117294	117320	117345
	 MURAZZANO R11	<input type="checkbox"/> Nat. Ret.	117281	117306		117331	117290	117316		117341		117295	117321	117346
UMBRIA ANTICA	 BIANCO R11	<input type="checkbox"/> Nat. Ret.	114301	114292		114283	114307	114298		114289		114304	114295	114286
	 GRIGIO R11	<input type="checkbox"/> Nat. Ret.	114302	114293		114284	114308	114299		114290		114305	114296	114287
	 ANTRACITE R11	<input type="checkbox"/> Nat. Ret.	114303	114294		114285	114309	114300		114291		114306	114297	114288
	 x 		1	2	2	2	1	1	1	1	1	1	1	1
	 m² x 													
	 Kg x 		19	28,2	26	18,5	19	14,1	13	9,2	19	14,1	13	9,2

I pesi riportati in tabella sono indicativi e potrebbero essere soggetti a leggere variazioni.
The weights stated in the chart may undergo slight changes for production reasons.
Les poids indiqués dans le tableau peuvent subir de légères variations pour des raisons de production.
Die in der Tabelle angegebenen Gewichte können aus Produktionsgründen geringfügigen Abweichungen unterliegen.

Non si garantisce l'abbinabilità tra fondi di spessori diversi e tra fondo e pezzo speciale.
It is not guaranteed that background tiles with different thicknesses can be used together, nor is it guaranteed for background tiles and trims.
Nous ne garantissons pas la possibilité de combiner des carrelages de sol de différentes épaisseurs et un carrelage de sol avec une pièce spéciale.
Die Kombinierbarkeit von Fliesen unterschiedlicher Stärke sowie zwischen Fliese und Formteil kann nicht garantiert werden.

* A disposizione solo su richiesta. Tempi di consegna 30 gg.
Available upon request only. Delivery terms: 30 days.
Disponible seulement sur requête. Délais de livraison: 30 jours.
Verfügbar auf Anfrage. Lieferzeit: 30 Tage.

Naturale e rettificato. Natural rectified. Naturel et rectifié. Natur Oberfläche und rektifiziert.
 Costa retta. Straight edge. Bord droit. Gerade Kante.
 Costa toro. Bullnose edge. Bord boudin. Abgerundete Kante.

Spessore · Thickness · Epaisseur · Stärke - 20 mm R11

Gres porcellanato colorato in massa. Full-body coloured porcelain stoneware. Grès cérame coloré dans la masse. In der Masse gefärbtes Feinsteinzeug.

		* Gradone bordo piscina				* Ang. Gradone bordo piscina - SX				* Ang. Gradone bordo piscina - DX				* Gradone Grip bordo piscina				* Ang. Gradone Grip bordo piscina - SX				* Ang. Gradone Grip bordo piscina - DX			
		40x120 16"x48"	30x120 12"x48"	30x90 12"x35½"	30x60 12"x24"	40x120 16"x48"	30x120 12"x48"	30x90 12"x35½"	30x60 12"x24"	40x120 16"x48"	30x120 12"x48"	30x90 12"x35½"	30x60 12"x24"	40x120 16"x48"	30x120 12"x48"	30x90 12"x35½"	30x60 12"x24"	40x120 16"x48"	30x120 12"x48"	30x90 12"x35½"	30x60 12"x24"	40x120 16"x48"	30x120 12"x48"	30x90 12"x35½"	30x60 12"x24"
APOGEO	WHITE R11	□ Nat. Ret.	■ 113627 ▶ 113663	■ 113615 ▶ 113651	■ 113603 ▶ 113639	■ 113767 ▶ 113791	■ 113759 ▶ 113783	■ 113751 ▶ 113775	■ 113763 ▶ 113787	■ 113755 ▶ 113779	■ 113747 ▶ 113771	■ 113699 ▶ 113735	■ 113687 ▶ 113723	■ 113675 ▶ 113711	■ 113815 ▶ 113839	■ 113807 ▶ 113831	■ 113799 ▶ 113823	■ 113811 ▶ 113835	■ 113803 ▶ 113827	■ 113795 ▶ 113819					
	GREY R11	□ Nat. Ret.	■ 113625 ▶ 113661	■ 113613 ▶ 113649	■ 113601 ▶ 113637	■ 113765 ▶ 113789	■ 113757 ▶ 113781	■ 113749 ▶ 113773	■ 113761 ▶ 113785	■ 113753 ▶ 113777	■ 113745 ▶ 113769	■ 113697 ▶ 113733	■ 113685 ▶ 113721	■ 113673 ▶ 113709	■ 113813 ▶ 113837	■ 113805 ▶ 113829	■ 113797 ▶ 113821	■ 113809 ▶ 113833	■ 113801 ▶ 113825	■ 113793 ▶ 113817					
	ANTHRACITE R11	□ Nat. Ret.	■ 113626 ▶ 113662	■ 113614 ▶ 113650	■ 113602 ▶ 113638	■ 113766 ▶ 113790	■ 113758 ▶ 113782	■ 113750 ▶ 113774	■ 113762 ▶ 113786	■ 113754 ▶ 113778	■ 113746 ▶ 113770	■ 113698 ▶ 113734	■ 113686 ▶ 113722	■ 113674 ▶ 113710	■ 113814 ▶ 113838	■ 113806 ▶ 113830	■ 113798 ▶ 113822	■ 113810 ▶ 113834	■ 113802 ▶ 113826	■ 113794 ▶ 113818					
	BLACK R11	□ Nat. Ret.	■ 113624 ▶ 113660	■ 113612 ▶ 113648	■ 113600 ▶ 113636	■ 113764 ▶ 113788	■ 113756 ▶ 113780	■ 113748 ▶ 113772	■ 113760 ▶ 113784	■ 113752 ▶ 113776	■ 113744 ▶ 113768	■ 113696 ▶ 113732	■ 113684 ▶ 113720	■ 113672 ▶ 113708	■ 113812 ▶ 113836	■ 113804 ▶ 113828	■ 113796 ▶ 113820	■ 113808 ▶ 113832	■ 113800 ▶ 113824	■ 113792 ▶ 113816					
AURUM STONE	PURE R11	□ Nat. Ret.		■ 102110 ▶ 102111		■ 102126 ▶ 102127		■ 102128 ▶ 102129		■ 102116 ▶ 102117		■ 102135 ▶ 102136		■ 102138 ▶ 102137											
CONCRETA	GRIGIO CHIARO R11	□ Nat. Ret.	■ 119370 ▶ 119415	■ 119355 ▶ 119400	■ 119340 ▶ 119385	■ 119545 ▶ 119575	■ 119535 ▶ 119565	■ 119525 ▶ 119555	■ 119540 ▶ 119570	■ 119530 ▶ 119560	■ 119520 ▶ 119550	■ 119460 ▶ 119505	■ 119445 ▶ 119490	■ 119430 ▶ 119475	■ 119605 ▶ 119635	■ 119595 ▶ 119625	■ 119585 ▶ 119615	■ 119600 ▶ 119630	■ 119590 ▶ 119620	■ 119580 ▶ 119610					
	GRIGIO SCURO R11	□ Nat. Ret.	■ 119371 ▶ 119416	■ 119356 ▶ 119401	■ 119341 ▶ 119386	■ 119546 ▶ 119576	■ 119536 ▶ 119566	■ 119526 ▶ 119556	■ 119541 ▶ 119571	■ 119531 ▶ 119561	■ 119521 ▶ 119551	■ 119461 ▶ 119506	■ 119446 ▶ 119491	■ 119431 ▶ 119476	■ 119606 ▶ 119636	■ 119596 ▶ 119626	■ 119586 ▶ 119616	■ 119601 ▶ 119631	■ 119591 ▶ 119621	■ 119581 ▶ 119611					
	TERRA R11	□ Nat. Ret.	■ 119372 ▶ 119417	■ 119357 ▶ 119402	■ 119342 ▶ 119387	■ 119547 ▶ 119577	■ 119537 ▶ 119567	■ 119527 ▶ 119557	■ 119542 ▶ 119572	■ 119532 ▶ 119562	■ 119522 ▶ 119552	■ 119462 ▶ 119507	■ 119447 ▶ 119492	■ 119432 ▶ 119477	■ 119607 ▶ 119637	■ 119597 ▶ 119627	■ 119587 ▶ 119617	■ 119602 ▶ 119632	■ 119592 ▶ 119622	■ 119582 ▶ 119612					
DEEP BLUE	GRIGIO R11	□ Nat. Ret.	■ 120120 ▶ 120121	■ 120127 ▶ 120128	■ 120134 ▶ 120135	■ 120250 ▶ 120251	■ 120254 ▶ 120255	■ 120258 ▶ 120259	■ 120262 ▶ 120263	■ 120266 ▶ 120267	■ 120270 ▶ 120271	■ 120183 ▶ 120184	■ 120190 ▶ 120191	■ 120197 ▶ 120198	■ 120280 ▶ 120281	■ 120284 ▶ 120285	■ 120288 ▶ 120289	■ 120292 ▶ 120293	■ 120296 ▶ 120297	■ 120300 ▶ 120301					
	ANTRACITE R11	□ Nat. Ret.	■ 120122 ▶ 120123	■ 120129 ▶ 120130	■ 120136 ▶ 120137	■ 120252 ▶ 120253	■ 120256 ▶ 120257	■ 120260 ▶ 120261	■ 120264 ▶ 120265	■ 120268 ▶ 120269	■ 120272 ▶ 120273	■ 120185 ▶ 120186	■ 120192 ▶ 120193	■ 120199 ▶ 120200	■ 120282 ▶ 120283	■ 120286 ▶ 120287	■ 120290 ▶ 120291	■ 120294 ▶ 120295	■ 120298 ▶ 120299	■ 120302 ▶ 120303					
EVOQUE	KORINA R11	□ Nat. Ret.	■ 105270 ▶ 105271			■ 105335 ▶ 105336			■ 105345 ▶ 105346			■ 105300 ▶ 105301			■ 105355 ▶ 105356			■ 105365 ▶ 105366							
	ROVERE R11	□ Nat. Ret.	■ 105272 ▶ 105273			■ 105337 ▶ 105338			■ 105347 ▶ 105348			■ 105302 ▶ 105303			■ 105357 ▶ 105358			■ 105367 ▶ 105368							
	DOUSSIE R11	□ Nat. Ret.	■ 105274 ▶ 105275			■ 105339 ▶ 105340			■ 105349 ▶ 105350			■ 105304 ▶ 105305			■ 105359 ▶ 105360			■ 105369 ▶ 105370							
	DOUGLAS R11	□ Nat. Ret.	■ 105276 ▶ 105277			■ 105341 ▶ 105342			■ 105351 ▶ 105352			■ 105306 ▶ 105307			■ 105361 ▶ 105362			■ 105371 ▶ 105372							
	BAHIA R11	□ Nat. Ret.	■ 105278 ▶ 105279			■ 105343 ▶ 105344			■ 105353 ▶ 105354			■ 105308 ▶ 105309			■ 105363 ▶ 105364			■ 105373 ▶ 105374							
			1	1	1	1	1	1	1	1	1	1	1	1	1	1	1	1	1	1	1	1	1	1	
			m² x																						
			Kg x																						

I pesi riportati in tabella sono indicativi e potrebbero essere soggetti a leggere variazioni.
The weights stated in the chart may undergo slight changes for production reasons.
Les poids indiqués dans le tableau peuvent subir de légères variations pour des raisons de production.
Die in der Tabelle angegebenen Gewichte können aus Produktionsgründen geringfügigen Abweichungen unterliegen.

Non si garantisce l'abbinabilità tra fondi di spessori diversi e tra fondo e pezzo speciale.
It is not guaranteed that background tiles with different thicknesses can be used together, nor is it guaranteed for background tiles and trims.
Nous ne garantissons pas la possibilité de combiner des carrelages de sol de différentes épaisseurs et un carrelage de sol avec une pièce spéciale.
Die Kombinierbarkeit von Fliesen unterschiedlicher Stärke sowie zwischen Fliese und Formteil kann nicht garantiert werden.

* A disposizione solo su richiesta. Tempi di consegna 30 gg.
Available upon request only. Delivery terms: 30 days.
Disponible seulement sur requête. Délais de livraison: 30 jours.
Verfügbar auf Anfrage. Lieferzeit: 30 Tage.

□ Naturale e rettificato. Natural rectified. Naturel et rectifié. Natur Oberfläche und rektifiziert.
■ Costa retta. Straight edge. Bord droit. Gerade Kante.
▶ Costa toro. Bullnose edge. Bord boudin. Abgerundete Kante.

Spessore . Thickness . Epaisseur . Stärke - 20 mm R11

Gres porcellanato colorato in massa. Full-body coloured porcelain stoneware. Grès cérame coloré dans la masse. In der Masse gefärbtes Feinsteinzeug.

		* Gradone bordo piscina				* Ang. Gradone bordo piscina - SX				* Ang. Gradone bordo piscina - DX				* Gradone Grip bordo piscina				* Ang. Gradone Grip bordo piscina - SX				* Ang. Gradone Grip bordo piscina - DX				
		40x120 16"x48"	30x120 12"x48"	30x90 12"x35½"	30x60 12"x24"	40x120 16"x48"	30x120 12"x48"	30x90 12"x35½"	30x60 12"x24"	40x120 16"x48"	30x120 12"x48"	30x90 12"x35½"	30x60 12"x24"	40x120 16"x48"	30x120 12"x48"	30x90 12"x35½"	30x60 12"x24"	40x120 16"x48"	30x120 12"x48"	30x90 12"x35½"	30x60 12"x24"	40x120 16"x48"	30x120 12"x48"	30x90 12"x35½"	30x60 12"x24"	
ILCOTTAGINA	NATURAL R11	<input type="checkbox"/> Nat. Ret.	■ 116368 ▶ 116404	■ 116350 ▶ 116386	■ 116524 ▶ 116560	■ 116506 ▶ 116542	■ 116518 ▶ 116554	■ 116500 ▶ 116536	■ 116440 ▶ 116476	■ 116422 ▶ 116458	■ 116596 ▶ 116632	■ 116578 ▶ 116614	■ 116590 ▶ 116626	■ 116572 ▶ 116608												
	CLEAR R11	<input type="checkbox"/> Nat. Ret.	■ 116369 ▶ 116405	■ 116351 ▶ 116387	■ 116525 ▶ 116561	■ 116507 ▶ 116543	■ 116519 ▶ 116555	■ 116501 ▶ 116537	■ 116441 ▶ 116477	■ 116423 ▶ 116459	■ 116597 ▶ 116633	■ 116579 ▶ 116615	■ 116591 ▶ 116627	■ 116573 ▶ 116609												
	RED R11	<input type="checkbox"/> Nat. Ret.	■ 116370 ▶ 116406	■ 116352 ▶ 116388	■ 116526 ▶ 116562	■ 116508 ▶ 116544	■ 116520 ▶ 116556	■ 116502 ▶ 116538	■ 116442 ▶ 116478	■ 116424 ▶ 116460	■ 116598 ▶ 116634	■ 116580 ▶ 116616	■ 116592 ▶ 116628	■ 116574 ▶ 116610												
	GREY R11	<input type="checkbox"/> Nat. Ret.	■ 116371 ▶ 116407	■ 116353 ▶ 116389	■ 116527 ▶ 116563	■ 116509 ▶ 116545	■ 116521 ▶ 116557	■ 116503 ▶ 116539	■ 116443 ▶ 116479	■ 116425 ▶ 116461	■ 116599 ▶ 116635	■ 116581 ▶ 116617	■ 116593 ▶ 116629	■ 116575 ▶ 116611												
MEDITERRANEA	DOR R11	<input type="checkbox"/> Nat. Ret.	■ 128501 ▶ 128502		■ 128561 ▶ 128562		■ 128571 ▶ 128572		■ 128531 ▶ 128532		■ 128581 ▶ 128582		■ 128591 ▶ 128592													
	BYBLOS R11	<input type="checkbox"/> Nat. Ret.	■ 128503 ▶ 128504		■ 128563 ▶ 128564		■ 128573 ▶ 128574		■ 128533 ▶ 128534		■ 128583 ▶ 128584		■ 128593 ▶ 128594													
	ERICE R11	<input type="checkbox"/> Nat. Ret.	■ 128505 ▶ 128506		■ 128565 ▶ 128566		■ 128575 ▶ 128576		■ 128535 ▶ 128536		■ 128585 ▶ 128586		■ 128595 ▶ 128596													
	MENFI R11	<input type="checkbox"/> Nat. Ret.	■ 128507 ▶ 128508		■ 128567 ▶ 128568		■ 128577 ▶ 128578		■ 128537 ▶ 128538		■ 128587 ▶ 128588		■ 128597 ▶ 128598													
METAL	IRON R11	<input type="checkbox"/> Nat. Ret.	■ 124502 ▶ 124503		■ 124562 ▶ 124563		■ 124572 ▶ 124573		■ 124532 ▶ 124533		■ 124592 ▶ 124593		■ 124582 ▶ 124583													
	CORTEN R11	<input type="checkbox"/> Nat. Ret.	■ 124504 ▶ 124505		■ 124564 ▶ 124565		■ 124574 ▶ 124575		■ 124534 ▶ 124535		■ 124594 ▶ 124595		■ 124584 ▶ 124585													
	OXIDE R11	<input type="checkbox"/> Nat. Ret.	■ 124506 ▶ 124507		■ 124566 ▶ 124567		■ 124576 ▶ 124577		■ 124536 ▶ 124537		■ 124596 ▶ 124597		■ 124586 ▶ 124587													
	TITANIUM R11	<input type="checkbox"/> Nat. Ret.	■ 124508 ▶ 124509		■ 124568 ▶ 124569		■ 124578 ▶ 124579		■ 124538 ▶ 124539		■ 124598 ▶ 124599		■ 124588 ▶ 124589													
NAMUR	BLANCHE R11	<input type="checkbox"/> Nat. Ret.	■ 136501 ▶ 136502	■ 136516 ▶ 136517	■ 136633 ▶ 136634	■ 136653 ▶ 136654	■ 136671 ▶ 136672	■ 136689 ▶ 136690	■ 136507 ▶ 136508	■ 136522 ▶ 136523	■ 136639 ▶ 136640	■ 136659 ▶ 136660	■ 136677 ▶ 136678	■ 136695 ▶ 136696												
	CENDRE R11	<input type="checkbox"/> Nat. Ret.	■ 136503 ▶ 136504	■ 136518 ▶ 136519	■ 136635 ▶ 136636	■ 136655 ▶ 136656	■ 136673 ▶ 136674	■ 136691 ▶ 136692	■ 136509 ▶ 136510	■ 136524 ▶ 136525	■ 136641 ▶ 136642	■ 136661 ▶ 136662	■ 136679 ▶ 136680	■ 136697 ▶ 136698												
	FONCÉ R11	<input type="checkbox"/> Nat. Ret.	■ 136505 ▶ 136506	■ 136520 ▶ 136521	■ 136637 ▶ 136638	■ 136657 ▶ 136658	■ 136675 ▶ 136676	■ 136693 ▶ 136694	■ 136511 ▶ 136512	■ 136526 ▶ 136527	■ 136643 ▶ 136644	■ 136663 ▶ 136664	■ 136681 ▶ 136682	■ 136699 ▶ 136700												
		1	1	1	1	1	1	1	1	1	1	1	1	1	1	1	1	1	1	1	1	1	1	1	1	
		18	13,5	9	14	10,5	7	14	10,5	7	18	13,5	9	14	10,5	7	14	10,5	7	14	10,5	7	14	10,5	7	

I pesi riportati in tabella sono indicativi e potrebbero essere soggetti a leggere variazioni.
The weights stated in the chart may undergo slight changes for production reasons.
Les poids indiqués dans le tableau peuvent subir de légères variations pour des raisons de production.
Die in der Tabelle angegebenen Gewichte können aus Produktionsgründen geringfügigen Abweichungen unterliegen.

Non si garantisce l'abbinabilità tra fondi di spessori diversi e tra fondo e pezzo speciale.
It is not guaranteed that background tiles with different thicknesses can be used together, nor is it guaranteed for background tiles and trims.
Nous ne garantissons pas la possibilité de combiner des carrelages de sol de différentes épaisseurs et un carrelage de sol avec une pièce spéciale.
Die Kombinierbarkeit von Fliesen unterschiedlicher Stärke sowie zwischen Fliese und Formteil kann nicht garantiert werden.

* A disposizione solo su richiesta. Tempi di consegna 30 gg.
Available upon request only. Delivery terms: 30 days.
Disponible seulement sur requête. Délais de livraison: 30 jours.
Verfügbar auf Anfrage. Lieferzeit: 30 Tage.

Naturale e rettificato. Natural rectified. Naturel et rectifié. Natur Oberfläche und rektifiziert.
 Costa retta. Straight edge. Bord droit. Gerade Kante.
 Costa toro. Bullnose edge. Bord boudin. Abgerundete Kante.

Spessore . Thickness . Epaisseur . Stärke - 20 mm R11

Gres porcellanato colorato in massa. Full-body coloured porcelain stoneware. Grès cérame coloré dans la masse. In der Masse gefärbtes Feinsteinzeug.

																		
		* Gradone svasato bordo piscina				* Ang. Gradone svasato bordo piscina - SX				* Ang. Gradone svasato bordo piscina - DX				* Griglia SX		* Griglia DX		
		40x120 16"x48"	30x120 12"x48"	30x90 12"x35½"	30x60 12"x24"	40x120 16"x48"	30x120 12"x48"	30x90 12"x35½"	30x60 12"x24"	40x120 16"x48"	30x120 12"x48"	30x90 12"x35½"	30x60 12"x24"	20x60 8"x24"	20x60 8"x24"	20x60 8"x24"	20x60 8"x24"	
APOGEO	 WHITE R11 <input type="checkbox"/> Nat. Ret.	▮113899 ▮113911	▮113895 ▮113907	▮113891 ▮113903		▮113863 ▮113887	▮113855 ▮113879	▮113847 ▮113871		▮113859 ▮113883	▮113851 ▮113875	▮113843 ▮113867		113591		113599		113595
	 GREY R11 <input type="checkbox"/> Nat. Ret.	▮113897 ▮113909	▮113893 ▮113905	▮113889 ▮113901		▮113861 ▮113885	▮113853 ▮113877	▮113845 ▮113869		▮113857 ▮113881	▮113849 ▮113873	▮113841 ▮113865		113589		113597		113593
	 ANTHRACITE R11 <input type="checkbox"/> Nat. Ret.	▮113898 ▮113910	▮113894 ▮113906	▮113890 ▮113902		▮113862 ▮113886	▮113854 ▮113878	▮113846 ▮113870		▮113858 ▮113882	▮113850 ▮113874	▮113842 ▮113866		113590		113598		113594
	 BLACK R11 <input type="checkbox"/> Nat. Ret.	▮113896 ▮113908	▮113892 ▮113904	▮113888 ▮113900		▮113860 ▮113884	▮113852 ▮113876	▮113844 ▮113868		▮113856 ▮113880	▮113848 ▮113872	▮113840 ▮113864		113588		113596		113592
AURUM STONE	 PURE R11 <input type="checkbox"/> Nat. Ret.			▮102140 ▮102141				▮102142 ▮102143				▮102144 ▮102145		102150		102151		102152
CONCRETA	 GRIGIO CHIARO R11 <input type="checkbox"/> Nat. Ret.	▮119710 ▮119725	▮119705 ▮119720	▮119700 ▮119715		▮119665 ▮119695	▮119655 ▮119685	▮119645 ▮119675		▮119660 ▮119690	▮119650 ▮119680	▮119640 ▮119670		119325		119335		119330
	 GRIGIO SCURO R11 <input type="checkbox"/> Nat. Ret.	▮119711 ▮119726	▮119706 ▮119721	▮119701 ▮119716		▮119666 ▮119696	▮119656 ▮119686	▮119646 ▮119676		▮119661 ▮119691	▮119651 ▮119681	▮119641 ▮119671		119326		119336		119331
	 TERRA R11 <input type="checkbox"/> Nat. Ret.	▮119712 ▮119727	▮119707 ▮119722	▮119702 ▮119717		▮119667 ▮119697	▮119657 ▮119687	▮119647 ▮119677		▮119662 ▮119692	▮119652 ▮119682	▮119642 ▮119672		119327		119337		119332
DEEP BLUE	 GRIGIO R11 <input type="checkbox"/> Nat. Ret.	▮120310 ▮120311	▮120314 ▮120315	▮120318 ▮120319		▮120322 ▮120323	▮120326 ▮120327	▮120330 ▮120331		▮120334 ▮120335	▮120338 ▮120339	▮120342 ▮120343		120350		120352		120354
	 ANTRACITE R11 <input type="checkbox"/> Nat. Ret.	▮120312 ▮120313	▮120316 ▮120317	▮120320 ▮120321		▮120324 ▮120325	▮120328 ▮120329	▮120332 ▮120333		▮120336 ▮120337	▮120340 ▮120341	▮120344 ▮120345		120351		120353		120355
EVOQUE	 KORINA R11 <input type="checkbox"/> Nat. Ret.	▮105380 ▮105381				▮105390 ▮105391				▮105400 ▮105401				105420		105425		105430
	 ROVERE R11 <input type="checkbox"/> Nat. Ret.	▮105382 ▮105383				▮105392 ▮105393				▮105402 ▮105403				105421		105426		105431
	 DOUSSIE R11 <input type="checkbox"/> Nat. Ret.	▮105384 ▮105385				▮105394 ▮105395				▮105404 ▮105405				105422		105427		105432
	 DOUGLAS R11 <input type="checkbox"/> Nat. Ret.	▮105386 ▮105387				▮105396 ▮105397				▮105406 ▮105407				105423		105428		105433
	 BAHIA R11 <input type="checkbox"/> Nat. Ret.	▮105388 ▮105389				▮105398 ▮105399				▮105408 ▮105409				105424		105429		105434
			1	1	1	1	1	1	1	1	1	1	1		1		1	
		21,5	18	13,5	9	21,5	14	10,5	7	21,5	14	10,5	7		6		6	
																		

I pesi riportati in tabella sono indicativi e potrebbero essere soggetti a leggere variazioni.
The weights stated in the chart may undergo slight changes for production reasons.
Les poids indiqués dans le tableau peuvent subir de légères variations pour des raisons de production.
Die in der Tabelle angegebenen Gewichte können aus Produktionsgründen geringfügigen Abweichungen unterliegen.

Non si garantisce l'abbinabilità tra fondi di spessori diversi e tra fondo e pezzo speciale.
It is not guaranteed that background tiles with different thicknesses can be used together, nor is it guaranteed for background tiles and trims.
Nous ne garantissons pas la possibilité de combiner des carrelages de sol de différentes épaisseurs et un carrelage de sol avec une pièce spéciale.
Die Kombinierbarkeit von Fliesen unterschiedlicher Stärke sowie zwischen Fliese und Formteil kann nicht garantiert werden.

* A disposizione solo su richiesta. Tempi di consegna 30 gg.
Available upon request only. Delivery terms: 30 days.
Disponible seulement sur requête. Délais de livraison: 30 jours.
Verfügbar auf Anfrage. Lieferzeit: 30 Tage.

Naturale e rettificato. Natural rectified. Naturel et rectifié. Natur Oberfläche und rektifiziert.
 Costa retta. Straight edge. Bord droit. Gerade Kante.
 Costa toro. Bullnose edge. Bord boudin. Abgerundete Kante.

Spessore · Thickness · Epaisseur · Stärke - 20 mm R11

Gres porcellanato colorato in massa. Full-body coloured porcelain stoneware. Grès cérame coloré dans la masse. In der Masse gefärbtes Feinsteinzeug.

		* Gradone svasato bordo piscina				* Ang. Gradone svasato bordo piscina - SX				* Ang. Gradone svasato bordo piscina - DX				* Griglia		* Griglia SX		* Griglia DX	
		40x120 16"x48"	30x120 12"x48"	30x90 12"x35½"	30x60 12"x24"	40x120 16"x48"	30x120 12"x48"	30x90 12"x35½"	30x60 12"x24"	40x120 16"x48"	30x120 12"x48"	30x90 12"x35½"	30x60 12"x24"	20x60 8"x24"	20x60 8"x24"	20x60 8"x24"	20x60 8"x24"		
ILCOTTAGINA	NATURAL R11	<input type="checkbox"/> Nat. Ret.	▮116656 ▮116692	▮116638 ▮116674		▮116668 ▮116704	▮116650 ▮116686		▮116662 ▮116698	▮116644 ▮116680			116332		116344		116338		
	CLEAR R11	<input type="checkbox"/> Nat. Ret.	▮116657 ▮116693	▮116639 ▮116675		▮116669 ▮116705	▮116651 ▮116687		▮116663 ▮116699	▮116645 ▮116681			116333		116345		116339		
	RED R11	<input type="checkbox"/> Nat. Ret.	▮116658 ▮116694	▮116640 ▮116676		▮116670 ▮116706	▮116652 ▮116688		▮116664 ▮116700	▮116646 ▮116682			116334		116346		116340		
	GREY R11	<input type="checkbox"/> Nat. Ret.	▮116659 ▮116695	▮116641 ▮116677		▮116671 ▮116707	▮116653 ▮116689		▮116665 ▮116701	▮116647 ▮116683			116335		116347		116341		
MEDITERRANEA	DOR R11	<input type="checkbox"/> Nat. Ret.	▮128621 ▮128622			▮128641 ▮128642			▮128631 ▮128632				128651		128671		128661		
	BYBLOS R11	<input type="checkbox"/> Nat. Ret.	▮128623 ▮128624			▮128643 ▮128644			▮128633 ▮128634				128652		128672		128662		
	ERICE R11	<input type="checkbox"/> Nat. Ret.	▮128625 ▮128626			▮128645 ▮128646			▮128635 ▮128636				128653		128673		128663		
	MENFI R11	<input type="checkbox"/> Nat. Ret.	▮128627 ▮128628			▮128647 ▮128648			▮128637 ▮128638				128654		128674		128664		
METAL	IRON R11	<input type="checkbox"/> Nat. Ret.	▮124612 ▮124613			▮124632 ▮124633			▮124622 ▮124623				124642		124662		124652		
	CORTEN R11	<input type="checkbox"/> Nat. Ret.	▮124614 ▮124615			▮124634 ▮124635			▮124624 ▮124625				124643		124663		124653		
	OXIDE R11	<input type="checkbox"/> Nat. Ret.	▮124616 ▮124617			▮124636 ▮124637			▮124626 ▮124627				124644		124664		124654		
	TITANIUM R11	<input type="checkbox"/> Nat. Ret.	▮124618 ▮124619			▮124638 ▮124639			▮124628 ▮124629				124645		124665		124655		
NAMUR	BLANCHE R11	<input type="checkbox"/> Nat. Ret.	▮136603 ▮136604	▮136624 ▮136625		▮136645 ▮136646	▮136665 ▮136666		▮136683 ▮136684	▮136701 ▮136702			136609		136630		136651		
	CENDRE R11	<input type="checkbox"/> Nat. Ret.	▮136605 ▮136606	▮136626 ▮136627		▮136647 ▮136648	▮136667 ▮136668		▮136685 ▮136686	▮136703 ▮136704			136610		136631		136652		
	FONCÉ R11	<input type="checkbox"/> Nat. Ret.	▮136607 ▮136608	▮136628 ▮136629		▮136649 ▮136650	▮136669 ▮136670		▮136687 ▮136688	▮136705 ▮136706			136611		136632		136653		
		<input type="checkbox"/> x <input type="checkbox"/>	1	1	1	1	1	1	1	1	1	1	1	1	1	1	1		
		m² x <input type="checkbox"/>	18	13,5	9	14	10,5	7	14	10,5	7		6		6		6		
		Kg x <input type="checkbox"/>																	

I pesi riportati in tabella sono indicativi e potrebbero essere soggetti a leggere variazioni.
The weights stated in the chart may undergo slight changes for production reasons.
Les poids indiqués dans le tableau peuvent subir de légères variations pour des raisons de production.
Die in der Tabelle angegebenen Gewichte können aus Produktionsgründen geringfügigen Abweichungen unterliegen.

Non si garantisce l'abbinabilità tra fondi di spessori diversi e tra fondo e pezzo speciale.
It is not guaranteed that background tiles with different thicknesses can be used together, nor is it guaranteed for background tiles and trims.
Nous ne garantissons pas la possibilité de combiner des carrelages de sol de différentes épaisseurs et un carrelage de sol avec une pièce spéciale.
Die Kombinierbarkeit von Fliesen unterschiedlicher Stärke sowie zwischen Fliese und Formteil kann nicht garantiert werden.

* A disposizione solo su richiesta. Tempi di consegna 30 gg.
Available upon request only. Delivery terms: 30 days.
Disponible seulement sur requête. Délais de livraison: 30 jours.
Verfügbar auf Anfrage. Lieferzeit: 30 Tage.

Naturale e rettificato. Natural rectified. Naturel et rectifié. Natur Oberfläche und rektifiziert.
 Costa retta. Straight edge. Bord droit. Gerade Kante.
 Costa toro. Bullnose edge. Bord boudin. Abgerundete Kante.

Spessore . Thickness . Epaisseur . Stärke - 20 mm R11

Gres porcellanato colorato in massa. Full-body coloured porcelain stoneware. Grès cérame coloré dans la masse. In der Masse gefärbtes Feinsteinzeug.

		* Gradone svasato bordo piscina					* Ang. Gradone svasato bordo piscina - SX					* Ang. Gradone svasato bordo piscina - DX					* Griglia	* Griglia SX	* Griglia DX	
		40x120	30x120	30x90	30x80	30x60	40x120	30x120	30x90	30x80	30x60	40x120	30x120	30x90	30x80	30x60	20x60	20x60	20x60	
		16"x48"	12"x48"	12"x35½"	12"x31½"	12"x24"	16"x48"	12"x48"	12"x35½"	12"x31½"	12"x24"	16"x48"	12"x48"	12"x35½"	12"x31½"	12"x24"	8"x24"	8"x24"	8"x24"	
PIETRA D'ORVIETO	BIANCO R11	□ Nat. Ret.	138708 138709	138836 138837	138716 138717	138844 138845	138724 138725	138852 138853				138732					138736			138740
	BEIGE R11	□ Nat. Ret.	138710 138711	138838 138839	138718 138719	138846 138847	138726 138727	138854 138855				138733					138737			138741
	SABBIA R11	□ Nat. Ret.	138712 138713	138840 138841	138720 138721	138848 138849	138728 138729	138856 138857				138734					138738			138742
	CENERE R11	□ Nat. Ret.	138714 138715	138842 138843	138722 138723	138850 138851	138730 138731	138858 138859				138735					138739			138743
PIETRA REGALE	ELVA R11	□ Nat. Ret.	117814 117815	117826 117827	117838 117839	117850 117851	117862 117863	117874 117875	117886 117887	117898 117899	117910 117911	117919					117927			117935
	RIVOLI R11	□ Nat. Ret.	117812 117813	117824 117825	117836 117837	117848 117849	117860 117861	117872 117873	117884 117885	117896 117897	117908 117909	117918					117926			117934
	OSTANA R11	□ Nat. Ret.	117810 117811	117822 117823	117834 117835	117846 117847	117858 117859	117870 117871	117882 117883	117894 117895	117906 117907	117917					117925			117933
	CHIANALE R11	□ Nat. Ret.	117806 117807	117818 117819	117830 117831	117842 117843	117854 117855	117866 117867	117878 117879	117890 117891	117902 117903	117915					117923			117931
	MURAZZANO R11	□ Nat. Ret.	117808 117809	117820 117821	117832 117833	117844 117845	117856 117857	117868 117869	117880 117881	117892 117893	117904 117905	117916					117924			117932
UMBRIA ANTICA	BIANCO R11	□ Nat. Ret.	114553 114580	114544 114571	114535 114562	114559 114586	114550 114577	114541 114568	114556 114583	114547 114574	114538 114565	114310					114316			114313
	GRIGIO R11	□ Nat. Ret.	114554 114581	114545 114572	114536 114563	114560 114587	114551 114578	114542 114569	114557 114584	114548 114575	114539 114566	114311					114317			114314
	ANTRACITE R11	□ Nat. Ret.	114555 114582	114546 114573	114537 114564	114561 114588	114552 114579	114543 114570	114558 114585	114549 114576	114540 114567	114312					114318			114315
	1	1	1	1	1	1	1	1	1	1	1	1	1	1	1	1	1	1	1	1
	m² x	21,5	18	13,5	12	9	21,5	14	10,5	10,5	7	21,5	14	10,5	10,5	7	6	6	6	6
	Kg x																			

I pesi riportati in tabella sono indicativi e potrebbero essere soggetti a leggere variazioni.
The weights stated in the chart may undergo slight changes for production reasons.
Les poids indiqués dans le tableau peuvent subir de légères variations pour des raisons de production.
Die in der Tabelle angegebenen Gewichte können aus Produktionsgründen geringfügigen Abweichungen unterliegen.

Non si garantisce l'abbinabilità tra fondi di spessori diversi e tra fondo e pezzo speciale.
It is not guaranteed that background tiles with different thicknesses can be used together, nor is it guaranteed for background tiles and trims.
Nous ne garantissons pas la possibilité de combiner des carrelages de sol de différentes épaisseurs et un carrelage de sol avec une pièce spéciale.
Die Kombinierbarkeit von Fliesen unterschiedlicher Stärke sowie zwischen Fliese und Formteil kann nicht garantiert werden.

* A disposizione solo su richiesta. Tempi di consegna 30 gg.
Available upon request only. Delivery terms: 30 days.
Disponible seulement sur requête. Délais de livraison: 30 jours.
Verfügbar auf Anfrage. Lieferzeit: 30 Tage.

□ Naturale e rettificato. Natural rectified. Naturel et rectifié. Natur Oberfläche und rektifiziert.
▬ Costa retta. Straight edge. Bord droit. Gerade Kante.
◐ Costa toro. Bullnose edge. Bord boudin. Abgerundete Kante.

IMBALLI

Packaging
Emballage
Verpackung



Cassa
Crate - Caisse - Kiste
175x344x30h
69"x135"x12"h
Formato lastra
Slab size . Dalle. Großformat.
160x320 cm - 63"x126"



Cassa
Crate - Caisse - Kiste
145x292x34h
57"x115"x13 1/2"h
Formato lastra
Slab size . Dalle. Großformat.
120x280 cm - 48"x110"

Cassa
Crate - Caisse - Kiste
132x291x38h
52"x114 1/2"x15"h
Formato lastra
Slab size . Dalle. Großformat.
120x270 cm - 48"x106"

PESO NETTO - NET WEIGHT POIDS NET - NETTOGEWICHT	Kg 120	Kg 90	Kg 80
------------------------------------------------------------	--------	-------	-------



Pallet Speciale con sponde
Special pallet with sides . Palette spéciale avec bords
Palette mit Hochbeetstecksystem
97x188x70h
38"x74"x27 1/2"h
Formato lastra/piastrella
Slab/tile size . Dalle/carrelage. Fliese und Großformat.
80x180 cm - 31 1/2"x71"



Pallet Speciale con sponde
Special pallet with sides . Palette spéciale avec bords
Palette mit Hochbeetstecksystem
123x144x65h
48 1/2"x56 1/2"x25 1/2"h
Formato lastra/piastrella
Slab/tile size . Dalle/carrelage. Fliese und Großformat.
120x120 cm - 48"x48"

PESO NETTO - NET WEIGHT POIDS NET - NETTOGEWICHT	Kg 70	Kg 53
------------------------------------------------------------	-------	-------



Cavalletto in legno
Wood A-Frame . Support en bois
A-Bock aus Holz
75x330x200h
29 1/2"x130"x79"h
Formato lastra
Slab size . Dalle. Großformat.
160x320 cm - 63"x126"



Cavalletto in legno
Wood A-Frame . Support en bois
A-Bock aus Holz
75x290x160h
29 1/2"x114"x63"
Formato lastra
Slab size . Dalle. Großformat.
120x270/280 cm - 48"x106"/110"



Cavalletto in lamiera
Iron A-Frame . Support en métal
A-Bock aus Metall
75x341x186h
29 1/2"x134"x73"h
Formato lastra
Slab size . Dalle. Großformat.
163x324 cm - 64"x127"

PESO NETTO - NET WEIGHT POIDS NET - NETTOGEWICHT	Kg 170	Kg 120	Kg 142
------------------------------------------------------------	--------	--------	--------

Le misure delle casse, dei cavalletti e dei pallet speciali sono indicativi e possono cambiare tra una fornitura e l'altra anche nel medesimo articolo.
The sizes of our crates, A-frames and special pallets are approximate and may vary from one supply to the next, even in the case of the same item being supplied.
Les mesures des caisses, des chevalets, des palettes spéciales sont indicatives et ils peuvent changer d'une fourniture à l'autre aussi dans le même article.
Die Maße der Kisten, Böcke und Spezialpaletten dienen lediglich als Richtmaße und können sich auch im selben Artikel von einer Lieferungen zur anderen ändern.

SERVIZIO CONSEGNE FINO A SASSUOLO

Delivery service to Sassuolo
Service de livraisons jusqu'à sassuolo
Lieferservice bis nach Sassuolo

Tagina S.p.A. fornisce il servizio di consegne presso il deposito Manelli di Baggiovara (MO) addebitando un importo di spesa calcolato in base al peso della spedizione.

Tagina S.p.A. provides the delivery service to Manelli's warehouse in Baggiovara (MO) charging an amount of calculated on the shipment's weight.

Tagina S.p.A. fournit le service de livraisons chez le dépôt Manelli à Baggiovara (MO) en facturant les frais de transport en fonction du poids de l'expédition.

Tagina S.p.A. liefert ab Werk ins Sammellager Manelli in Baggiovara (MO) und berechnet die Kosten folgendermaße.

CERTIFICAZIONI

Certifications
Certifications
Zertifizierung

Inquadrare i qr code per scaricare i seguenti manuali tecnici

Scan the QR codes to download the following technical manuals.
Scanner les codes QR pour télécharger les manuels techniques suivants.
Scannen Sie die QR-Codes, um die folgenden technischen Handbücher herunterzuladen.

100% Made in Italy



CATALOGHISTICA TECNICA

Technical catalogues
Catalogues techniques
Technische Kataloge

Scarica i manuali tecnici di Tagina

Download Tagina technical catalogues.
Téléchargez le manuels techniques de Tagina.
Laden Sie die technischen Kataloge von Tagina herunter.

PULIZIA E MANUTENZIONE DEL PRODOTTO

Product cleaning and maintenance
Nettoyage et entretien du produit
Reinigung und Wartung des Produkts

GRANDI FORMATI: GESTIONE ED OPERATIVITÀ

LARGE SIZES: management and operating
GRANDS FORMATS: gestion et fonctionnement
GROßFORMATE: Management und Betrieb

PERSONALIZZARE LA SALA MOSTRA

Customising the showroom
Personnaliser la salle d'exposition
Den Ausstellungsraum individuell gestalten

SCHEMI DI POSA

Laying patterns
Plans de pose
Verlegschema

CONDIZIONI GENERALI DI VENDITA

AMBITO DI APPLICAZIONE

Le presenti condizioni generali di vendita (“CGV”) si applicheranno a tutte le forniture di piastrelle in ceramica o altri prodotti in ceramica (prodotti) che saranno eseguite nei confronti di qualsiasi cliente (cliente) da Tagina S.p.A. anche se le CGV non verranno di volta in volta espressamente richiamate, menzionate nei contratti di vendita ovvero espressamente accettate dal cliente.

APPROVAZIONE

Il cliente invia, via mail, fax o con altri strumenti telematici, a Tagina S.p.A., direttamente o per il tramite di agenti, gli ordini scritti che rappresentano i contratti di vendita solo dopo la conferma scritta di Tagina S.p.A..

In nessun caso Tagina S.p.A. sarà vincolata da eventuali condizioni generali di contratto dei clienti, neanche qualora esse siano richiamate o riportate negli ordini e/o in qualsiasi altra documentazione trasmessa a Tagina S.p.A. dai clienti. Nessun comportamento di Tagina S.p.A. potrà essere interpretato o utilizzato al fine di esprimere tacita accettazione di Tagina S.p.A. alle condizioni generali di contratto del cliente.

In nessun caso Tagina S.p.A. sarà vincolata da atti e/o azioni dei propri agenti, essendo questi ultimi privi del potere di vincolare Tagina S.p.A..

La vendita dovrà ritenersi conclusa nel momento in cui il cliente riceva da parte di Tagina S.p.A. una conferma scritta via e-mail, fax o altri mezzi telematici, conforme ai termini ed alle condizioni dell'ordine; o in caso di conferma inviata da Tagina S.p.A. contenente condizioni difformi dall'ordine ricevuto dal cliente quando questi l'accetti per iscritto o comunque non contesti entro 7 (sette) giorni dalla ricezione; o in assenza di conferma scritta da parte della Tagina S.p.A., nel momento in cui i prodotti saranno consegnati e caricati dal cliente.

CONSEGNA

La vendita è sempre franco stabilimento di Tagina S.p.A.. La merce viaggia a rischio e pericolo del cliente ed ogni responsabilità di Tagina S.p.A. cessa con la consegna al vettore, nei confronti del quale il cliente, effettuate le opportune verifiche, dovrà sporgere eventuali reclami.

Le spedizioni, via mare o via terra, concernenti forniture sull'estero, vengono effettuate in base alle condizioni scelte di volta in volta, riportate negli “Incoterms 2020” approvati dalla camera di commercio internazionale.

TERMINI DI CONSEGNA

I termini di consegna s'intendono in ogni caso non essenziali né perentori ma hanno carattere puramente indicativo, eventuali ritardi nelle consegne, interruzioni, sospensioni totali o parziali delle forniture non daranno diritto ad indennizzi o risarcimento danni. In nessun caso di ritardi nella consegna dei prodotti il cliente avrà il diritto di risolvere il contratto di vendita.

Se trascorsi 15 (quindici) giorni dalla data di avviso di merce pronta, il cliente non ritira il materiale Tagina S.p.A. si riserva di stabilire discrezionalmente un nuovo termine di consegna.

GARANZIE E RECLAMI

I nostri materiali sono garantiti conformi alle norme UNI-DIN-EN attualmente in vigore. La nostra garanzia è limitata ai materiali di sola 1° scelta con tolleranza del 5% (sono esclusi pertanto i materiali di 2°, secondaria, commerciale, 3° e partite occasionali). Al momento del ricevimento della merce il cliente ha obbligo di verificare la merce in

termini di qualità, quantità, danneggiamenti degli imballi e/o eventuali ammanchi ed avarie entro breve tempo dal ricevimento e, in caso di reclamo, darne comunicazione per iscritto entro e non oltre 8 (otto) giorni dal ricevimento della stessa e, comunque, prima della posa in opera dei prodotti pena la decadenza di ogni diritto. La garanzia del venditore decade quando il prodotto ancorché affetto da vizi palesi sia stato utilizzato o trasformato in quanto si ritiene che l'acquirente o il suo cliente l'abbia di fatto accettato.

Il materiale considerato difettoso dovrà essere tenuto a disposizione di Tagina S.p.A. per le verifiche che riterrà opportuno effettuare; ogni ulteriore azione (restituzione, riparazione o altro) dovrà essere da noi preventivamente autorizzata per iscritto. L'installazione, anche parziale, del materiale costituisce accettazione incondizionata della conformità dei beni acquistati. I nostri materiali sono da classificarsi fra i prodotti cotti ad alta temperatura e come tali possono presentare differenze fra le dimensioni dichiarate e quelle effettivamente consegnate. Così si dica per le differenze di tono all'interno della medesima partita. Quanto sopra perciò non potrà essere oggetto di reclamo da parte del committente. L'eventuale comunicazione di reclami dovrà contenere, oltre i dati di fatturazione, una precisa descrizione del vizio e un adeguato reportage fotografico che lo evidenzi. Nel caso in cui il reclamo risultasse essere infondato, il cliente dovrà risarcire Tagina S.p.A. di tutte le spese sostenute per l'accertamento (viaggi, perizie, etc...). La responsabilità di Tagina S.p.A. è strettamente limitata alla sostituzione dei soli pezzi risultati difettosi o alla riparazione, con espressa esclusione di ulteriori specifici indennizzi quali, a titolo indicativo ma non limitativo, per costi di rimozione, attrezzature, macchinari, mancati guadagni per interruzione o sospensione di attività, disagi danni indiretti etc...

I limiti temporali della durata della garanzia sono quelli stabiliti dal codice civile italiano.

SOLVE ET REPETE

Per nessun motivo, ivi compresi vizi o difetti del materiale, il cliente potrà sospendere o ritardare il pagamento del materiale ritirato, salva naturalmente la facoltà di ripetere quando possa dimostrare di avere indebitamente pagato.

IMBALLO E QUANTITÀ

I prodotti saranno imballati ed approntati per la spedizione secondo i sistemi di protezione generalmente adottati da Tagina S.p.A. e secondo le modalità di trasporto convenute. Qualora il cliente ritenga necessario l'impiego di imballaggi speciali o di protezioni aggiuntive dovrà farne espressa richiesta a Tagina S.p.A., fermo restando che, in tal caso, saranno a carico del cliente tutti i relativi costi.

Il buono stato degli imballi e della loro confezione nonché della quantità consegnata resta accertato con l'accettazione della merce da parte del vettore. Questi, firmando i documenti di trasporto, si rende responsabile del buono stato del materiale e del quantitativo. Il compratore nel caso si verifichino rotture ed ammanchi dovrà chiedere eventuali danni o risarcimenti al vettore.

RESI

Per nessuna ragione il cliente potrà restituire il materiale senza nostra espressa preventiva autorizzazione scritta e tutte le spese, compresi i costi di movimentazione nei nostri magazzini della merce resa, sono a carico del cliente.

PREZZI

I prezzi riportati sui nostri listini non sono per noi impegnativi e s'intendono in euro, al netto di iva, ovvero nella valuta indicata nella fattura di vendita. Ci riserviamo il diritto di modificarli prima dell'accettazione dell'ordine. I prezzi pattuiti per ogni singola vendita, si intendono al netto per contanti per consegna franco stabilimento, salvo diversa pattuizione scritta. Se fra la data di ordinazione (anche dopo la conferma d'ordine) e quella di consegna, si verificassero aumenti nei costi delle materie prime, della manodopera, dei combustibili, nelle spese di produzione, di trasporto, etc. Tagina S.p.A. potrà aumentare il prezzo convenuto dandone comunicazione scritta al cliente. Tuttavia qualora tale prezzo superi del 20% quello convenuto al momento dell'ordinazione, il cliente potrà recedere dal contratto, notificandoci per iscritto tale sua volontà entro il termine di 10 (dieci) giorni dal ricevimento dell'avviso di aumento del prezzo. In difetto, il nuovo prezzo si intenderà accettato.

PAGAMENTI

I pagamenti devono essere effettuati dal cliente con le modalità e nei tempi indicati nella conferma d'ordine e concordati fra le parti. I pagamenti dovranno essere effettuati in euro ovvero in conformità della valuta che Tagina S.p.A. indicherà nella relativa fattura di vendita.

I pagamenti si considerano effettuati dal cliente solo nel momento in cui il relativo importo sarà stato accreditato sul conto corrente di Tagina S.p.A.. Eventuali pagamenti fatti ad agenti, rappresentanti, ausiliari di commercio di Tagina S.p.A., non si intendono effettuati finché le relative somme non saranno state accreditate sul conto corrente di Tagina S.p.A.. Qualsiasi ritardo o irregolarità nel pagamento costituisce grado di insolvenza e offre a Tagina S.p.A. la facoltà di sospendere le forniture ed annullare e risolvere i contratti in corso; esigere l'immediato ed integrale pagamento di ogni nostro credito, anche se sia stato convenuto un pagamento a rate e/o un pagamento dilazionato e/o siano stati emessi o siano in scadenza titoli di credito o altri strumenti di pagamento ed, inoltre, agire giudizialmente al riguardo, in via esecutiva o cautelativa nonché per il risarcimento danni. Tagina S.p.A. ha comunque diritto a decorenza dalla scadenza del pagamento, senza necessità di messa in mora, “agli interessi moratori” in conformità alla legge applicabile e vigente.

SERVIZIO CONSEGNE FINO A SASSUOLO

Tagina S.p.A. fornisce il servizio di consegne presso spedizionieri di Sassuolo e comprensorio per il quale Tagina S.p.A. provvederà ad addebitare un importo di spese in base al peso della spedizione.

RISERVATO DOMINIO

Il materiale anche se spedito e regolarmente fatturato resta di proprietà di Tagina S.p.A. fino al pagamento totale della fornitura medesima da parte del cliente come disposto dal codice civile sul riservato dominio ai sensi degli artt. 1523 E seguenti.

CESSIONE DEL CONTRATTO

Il cliente non può cedere la sua posizione nel contratto od in singoli rapporti obbligatori da questo derivanti senza l'accettazione scritta di Tagina S.p.A.: anche in tale caso il cliente rimane comunque solidamente responsabile col cessionario per le obbligazioni cedute.

DIVIETO DI ESPORTAZIONE

Tagina S.p.A. è titolare e legittimo detentore di esclusive relative ai marchi al fine di garantire al meglio tali diritti, Tagina S.p.A. effettua le forniture dei propri prodotti mediante un sistema di distribuzione selettiva. Tali forniture sono destinate all'installazione presso l'utente finale. Non viene pertanto autorizzata nessun tipo di rivendita ad altro soggetto commerciale, salvo previa autorizzazione scritta da parte di Tagina S.p.A.. La violazione a quanto sopra riportato può considerarsi equiparata ad un uso illecito delle proprietà intellettuali e industriali di Tagina S.p.A., con diritto pertanto di quest'ultima di chiederne il sequestro presso qualunque detentore. Tagina S.p.A. si riserva il diritto di procedere giudizialmente nei confronti di chiunque sia coinvolto in rivendite non autorizzate. Salvo accordi in contrario, è fatto divieto al cliente di esportare i nostri prodotti oggetto della fornitura.

CAMPIONI

I dati figuranti nei documenti illustrativi di Tagina S.p.A., così come le caratteristiche dei campioni e modelli da quest'ultima inviati al cliente, hanno carattere di indicazioni approssimative. Queste informazioni non hanno valore impegnativo se non nella misura in cui siano stati espressamente menzionati come tali nell'offerta o nell'accettazione scritta di Tagina S.p.A..

MARCHI E SEGNI DISTINTIVI DEL VENDITORE

L'utilizzo dei marchi, dei modelli ornamentali e delle opere dell'ingegno in genere, in qualunque forma o modo di espressione (quali a titolo meramente esemplificativo, ma non esaustivo: immagini, foto, disegni, filmati, figure, strutture, ecc. ecc.) costituenti proprietà intellettuale di Tagina S.p.A. attraverso qualsiasi mezzo (quali a titolo meramente esemplificativo, ma non esaustivo: stampa, video, radio, internet, social media, piattaforme di messaggistica istantanea, ecc. ecc.) è severamente vietato. Qualsiasi deroga a tale divieto, anche solamente parziale, dovrà essere autorizzata per iscritto, caso per caso, dalla Tagina S.p.A..

LINGUA DEL CONTRATTO, FORO COMPETENTE

Il testo delle presenti CGV è redatto in lingua italiana e tale testo prevarrà su qualsiasi testo redatto in altra lingua.

Il contratto è disciplinato dalla legge italiana, per qualsiasi controversia sarà esclusivamente competente il foro di Ravenna.

Per qualsiasi controversia comunque derivante dal contratto di fornitura, tanto da parte della Tagina S.p.A. come da parte del cliente, è esclusivamente competente il foro di Ravenna. È comunque facoltà di Tagina S.p.A. adire fori alternativi.

General terms and conditions of sale

SCOPE OF APPLICATION

These general terms and conditions of sale (“GTCS”) will apply to all supplies of ceramic tiles or other ceramic products (Products) that will be carried out in favour of any customer (CUSTOMER) by Tagina S.p.A., even if the GTCS may not be expressly recalled each time, mentioned in the sales contracts or expressly accepted by the CUSTOMER.

APPROVAL

The CUSTOMER shall send the written orders to the Tagina SpA through e-mail; fax or electronic transmission tools, directly or through the agents; and the written orders represent the sales contracts only after our written confirmation. Under no circumstances shall Tagina S.p.A. be bound by any general terms and conditions of the CUSTOMERS' contract, even if they are recalled or shown in the orders and/or any other documentation transmitted to Tagina S.p.A. by the CUSTOMERS. No conduct of Tagina S.p.A. may be interpreted or used in order to express tacit acceptance by Tagina S.p.A. under the general terms and conditions of the CUSTOMER's contract.

In no case shall Tagina S.p.A. be bound by the acts and/or actions of its Agents, since the latter does not have the power to bind Tagina S.p.A..

The sale must be considered concluded when the CUSTOMER receives a written confirmation from Tagina S.p.A. by e-mail, fax or other electronic means, in accordance with the terms and conditions of the order; or in case of confirmation sent by Tagina S.p.A., containing conditions different from the order received by the CUSTOMER when the customer accepts it in writing or in any case does not dispute it within 7 (seven) days of receipt; or in the absence of written confirmation by Tagina S.p.A., at the time when the products are delivered and accepted by the CUSTOMER.

DELIVERY

The sale is always ex-works of Tagina S.p.A.. The goods travel at the risk of the CUSTOMER and all our responsibilities cease with delivery to the carrier, against which the CUSTOMER, carrying out the appropriate checks, must make any complaints. Shipments, by sea or by land, concerning supplies abroad, are made according to the conditions chosen each time, reported in the “Incoterms 2020” approved by the International Chamber of Commerce.

TERMS OF DELIVERY

The terms of delivery are understood, in any case, as not essential or peremptory, but are purely indicative. Any delays in deliveries, interruptions, total or partial suspensions of the supply will not entitle the CUSTOMER to indemnity or compensation for damages. In no case do delays in the delivery of the Products entitle the CUSTOMER to the right to terminate the sales contract. If the CUSTOMER does not collect the goods, after 15 (fifteen) days from the date of the “goods ready” notice, Tagina SpA has the right – at its discretion – to establish a new delivery date.

WARRANTY AND COMPLAINTS

Our materials are guaranteed to comply with the UNI-DIN-EN standards currently in force. Our warranty is limited to materials of only 1st choice with a 5% tolerance (therefore, materials of 2nd, secondary, commercial, 3rd and occasional consignments are excluded). At the time of receipt of the goods, the CUSTOMER is obliged to verify the goods

in terms of quality, quantity, damage to the packaging and/or any shortfall and failures within a short time from receipt and, in case of complaint, he or she must communicate it in writing no later than 8 (EIGHT) days after receipt of the same and, in any case, before the installation of the products under penalty of forfeiture of all rights.

The seller’s warranty is void when the product, even if affected by evident defects, has been used or transformed in that it is believed that the buyer or their customer has in fact accepted it.

The material considered defective must be kept at the disposal of Tagina S.p.A. for the verifications that it deems appropriate to carry out; any further action (return, repair or otherwise) must be authorised by us in advance in writing.

The installation, even partial, of the material constitutes unconditional acceptance of the conformity of the purchased goods.

Our materials are to be classified among products fired at high temperature and, as such, may have differences between the declared dimensions and those actually delivered. The same is true for the differences in tone within the same consignment.

The above cannot therefore be the subject of a complaint by the CUSTOMER.

Any communication of complaints must contain, in addition to the invoicing data, a precise description of the defect and an adequate photographic documentation that highlights it. In the event that the complaint turns out to be unfounded, the CUSTOMER will have to compensate Tagina S.p.A. for all expenses incurred for the investigation (travel, expert opinions, etc.).

Tagina S.p.A.'s liability is strictly limited to the replacement of only the pieces that turn out to be defective or to their repair, with the express exclusion of further specific compensation such as, merely by way of example, for removal costs, equipment, machinery, lost earnings due to interruption or suspension of activities, inconvenience of indirect damage, and so forth. The time limits of the duration of the warranty are those established by the Italian Civil Code.

ESTOPPEL CLAUSE

For no reason, including defects or lack of quality in the material, may the buyer suspend or delay the payment of the collected material, without prejudice, of course, to the right to refund when he or she can prove that the material has been unduly charged.

PACKAGING AND QUANTITY

The Products will be packed and prepared for shipment according to the protection systems generally adopted by Tagina S.p.A. and according to the agreed modes of transport.

If the CUSTOMER deems it necessary to use special packaging or additional protections, he or she must make an express request to Tagina S.p.A., it being understood that, in this case, all the related costs will be borne by the CUSTOMER.

The good condition of the packing materials and packaging as well as the quantity delivered remains ascertained with the acceptance of the goods by the carrier. By signing the Transport DocumentS, the carrier is responsible for the good condition of the material and the quantity.

The buyer, in the event of breakage and shortfall, must make requests for any compensation for damages to the carrier.

RETURNS

For no reason can the CUSTOMER return the material without our express prior written authorisation and all expenses, including the costs of handling the returned goods in our warehouses, shall be borne by the CUSTOMER.

PRICES

The prices shown on our price lists are not binding for us and are understood in Euro, net of VAT, or in the currency indicated on the sales invoice. We reserve the right to change them before accepting the order. The prices agreed for each individual sale shall be defined net in cash for ex-works delivery, unless otherwise stipulated in writing. If between the date of ordering (even after the order confirmation) and the date of delivery, there have been increases in the costs of raw materials, labour, fuels, production, transport, etc., Tagina S.p.A. may increase the agreed price by giving written notice of the same to the CUSTOMER. However, if this price exceeds the price agreed at the time of ordering by 20%, the CUSTOMER may withdraw from the contract, notifying us in writing of his or her intention within 10 (TEN) days of receipt of the notice of price increase. Lacking the above, the new price will be understood as accepted.

PAYMENT

Payments must be made by the CUSTOMER in the manner and timing indicated in the order confirmation and agreed between the parties. Payments must be made in Euro or in accordance with the currency that Tagina S.p.A. will indicate in the relevant sales invoice. Payments are considered made by the CUSTOMER only when the relevant amount has been credited to the current account of Tagina S.p.A.. Any payments made to agents, representatives, trade auxiliaries of Tagina S.p.A., are not deemed to have been made until the related sums have been credited to the current account of Tagina S.p.A.. Any delay or irregularity in payment constitutes a degree of insolvency and offers Tagina S.p.A. the right to suspend supplies and cancel and terminate current contracts; demand the immediate and full payment of all our claims, even if an instalment payment and/or an extended payment has been agreed and/or securities or other payment instruments have been issued or are expiring and, in addition, it may take legal action in this regard, either as an executive or precautionary measure as well as for compensation for damages. Tagina S.p.A. is, however, entitled, at the moment of the expiry of the payment, without the need for formal notice, to “default interest” in accordance with applicable and current law.

LANGUAGE OF THE CONTRACT, COURT OF JURISDICTION

The text of these GTCS is written in Italian and that text will prevail over any text drawn up in another language.

The contract is governed by Italian law, for any dispute, the Court of Ravenna shall have exclusive jurisdiction. For any dispute arising from the supply contract, both by Tagina S.p.A. and by the CUSTOMER, the Court of Ravenna shall have exclusive jurisdiction. It is however the right of Tagina S.p.A. to opt for alternative Courts.

DELIVERY SERVICE TO SASSUOLO

Tagina S.p.A. provides the delivery service to shippers in Sassuolo and the area for which Tagina S.p.A. will charge an amount of expenses based on the weight of the shipment.

RESERVED OWNERSHIP

The material, even if shipped and regularly invoiced, remains the property of Tagina S.p.A. until the total payment of the same by the CUSTOMER, as required by the Italian Civil Code on Reserved Ownership pursuant to arts. 1523 and following.

TRANSFER OF THE CONTRACT

The CUSTOMER may not transfer his or her position in the contract or in individual mandatory relationships deriving from it without the written acceptance of Tagina

S.p.A.: even in this case, the CUSTOMER remains jointly responsible with the transferee for the obligations transferred.

EXPORT BAN

Tagina S.p.A. is the owner and legitimate holder of exclusive rights relating to the trademarks. In order to ensure these rights to the fullest, Tagina S.p.A. supplies its products through a selective distribution system. These supplies are intended for installation at the premises of the end user. No resale to another commercial entity is therefore authorised, unless prior authorisation in writing has been granted by Tagina S.p.A..

The infringement of the herein above may be considered to be equated with an unlawful use of the intellectual and industrial rights of Tagina S.p.A., with the latter's right to request its seizure from any holder. Tagina S.p.A. reserves the right to proceed in court against anyone involved in unauthorised resale activities. Unless otherwise agreed, the CUSTOMER is prohibited from exporting our products that are the subject of the supply.

SAMPLES

The data contained in the illustrative materials of Tagina S.p.A., as well as the characteristics of the samples and models sent by the latter to the CUSTOMER, are approximate indications. This information is of no binding value unless it has been expressly mentioned as such in the offer or written acceptance of Tagina S.p.A..

SELLER'S TRADEMARKS AND DISTINCTIVE SIGNS

The use of trademarks, ornamental designs and creative works in general, in whatever form and manner of expression (such as, by way of a non-limiting example: images, photos, drawings, videos, shapes, structures, etc.) constituting intellectual property of Tagina SpA, through any means (such as, by way of a non-limiting example: press, video, radio, internet, social media, instant messaging platforms or VoIP, etc.) is strictly forbidden. Any exception to the said prohibition, even only partial, must be authorised in writing, each time, by Tagina S.p.A..

LANGUAGE OF THE CONTRACT, COURT OF JURISDICTION

The text of these GTCS is written in Italian and that text will prevail over any text drawn up in another language.

The contract is governed by Italian law, for any dispute, the Court of Ravenna shall have exclusive jurisdiction. For any dispute arising from the supply contract, both by Tagina S.p.A. and by the CUSTOMER, the Court of Ravenna shall have exclusive jurisdiction. It is however the right of Tagina S.p.A. to opt for alternative Courts.

CARATTERISTICHE TECNICHE

Technical features
Caracteristiques techniques
Technische Eigenschaften

LASTRE IN GRES PORCELLANATO PRESSATE A SECCO

Dry-pressed porcelain stoneware slabs . Dalles en grès cérame pressées à sec . Trocken gepresste Platten aus Feinsteinzeug.

GRES PORCELLANATO COLORATO IN MASSA

Full-body coloured porcelain stoneware / Grès cérame coloré dans la masse / In der Masse gefärbtes Feinsteinzeug.

CARATTERISTICA Specification Caracteristique Eigenschaft	NORMA Standards Norme Norm	RISULTATO PROVA Test results Resultats des essais Ergebnisse
 Classificazione prodotto Product classification Classification produit Produktklassifizierung	UNI EN 14411- Allegato G ISO 13006 UNI EN 14411- Appendix G ISO 13006 UNI EN 14411- Appendice G ISO 13006 UNI EN 14411- Anhang G ISO 13006	Gruppo B1a GL Group B1a GL Groupe B1a GL Gruppe B1a GL
 Caratteristiche dimensionali e d'aspetto Dimensional characteristics Caractéristiques dimensionnelles Abmessungen	UNI EN ISO 10545-2	Conforme alla norma. Complies with the standards. Conforme aux normes. Anforderungenerfüllt.
 Assorbimento di acqua Water absorption Absorption d'eau Wasseraufnahme	UNI EN ISO 10545-3	Conforme alla norma. Complies with the standards. Conforme aux normes. Anforderungenerfüllt.
 Resistenza alla flessione Breaking stress Résistance à la flexion Biegefestigkeit	UNI EN ISO 10545-4	Conforme alla norma. Complies with the standards. Conforme aux normes. Anforderungenerfüllt.
 Sforzo di rottura Breaking stress Effort de rupture Bruchkraft		Conforme alla norma. Complies with the standards. Conforme aux normes. Anforderungenerfüllt.
 Resistenza all'abrasione delle piastrelle non smaltate Deep abrasion resistance of unglazed tiles Résistance à l'abrasion profonde des carreaux non émaillés Beständig gegenüber Tiefenabrieb der unglasierten Fliesen	UNI EN ISO 10545-6	-
 Resistenza all'abrasione delle piastrelle smaltate Abrasion resistance of glazed tiles Résistance à l'abrasion des carreaux émaillés Abriebfestigkeit der glasierten Fliesen	UNI EN ISO 10545-7	Secondo quanto dichiarato. As stated by the Company. D'après déclaration de l'établissement. Entsprechend der Angaben des Unternehmens.
 Dilatazione termica lineare Linear thermal expansion Dilatation thermique linéaire Lineare Wärmedehnung	UNI EN ISO 10545-8	7x10 ⁻⁶ C ⁻¹
 Resistenza agli sbalzi termici Thermal shock resistance Résistance aux écarts thermiques Beständigkeit gegenüber Temperaturschwankungen	UNI EN ISO 10545-9	Resistente. Resistant. Résiste. Erfüllt.
 Resistenza al cavillo Crazing resistance Résistance aux craquelures Beständigkeit gegenüber Glasurrisen	UNI EN ISO 10545-11	Resistente. Resistant. Résiste. Erfüllt.
 Resistenza al gelo Frost resistance Résistance au gel Frostbeständigkeit	UNI EN ISO 10545-12	Resistente. Resistant. Résiste. Erfüllt.
 Resistenza ai prodotti chimici Chemical resistance Résistance aux produits chimiques Beständig gegenüber Chemikalien	UNI EN ISO 10545-13	Resistente. Resistant. Résiste. Erfüllt.
 Resistenza alle macchie Stain resistance Résistance aux taches Beständigkeit gegenüber Flecken	UNI EN ISO 10545-14	Resistente. Resistant. Résiste. Erfüllt.
 Stabilità dei colori alla luce Colour stability upon exposure to light Stabilité des couleurs à la lumière Stabilität der Farben gegenüber dem Licht	DIN 51094	Conforme alla norma. Complies with the standards. Conforme aux normes. Anforderungenerfüllt.
 Resistenza alla scivolosità Friction coefficient (slip level) Coefficient de friction (glissance) Reibungskoeffizient (Glätte)	DIN 51130	A richiesta. / Available on request. / Sur demande. / Anforderungenerfüllt.
	DIN 51097	A richiesta. / Available on request. / Sur demande. / Anforderungenerfüllt.
	B.C.R.A.-D.M. 236/89	A richiesta. / Available on request. / Sur demande. / Anforderungenerfüllt.
	DCOF (BOOT 3000 -section 9.6 ANSI 137.2012)	A richiesta. / Available on request. / Sur demande. / Anforderungenerfüllt.
 Resistenza al sale Salt resistance Résistance au sel Beständigkeit gegenüber Salz	NaCl	Resistente. Resistant. Résiste. Erfüllt.
 Resistenza al fuoco Reaction to fire Réaction au feu Brandschutz kaasse	UNI EN 13501-1-2009	A richiesta. Available on request. Sur demande. Anforderungenerfüllt.

LASTRE IN GRES PORCELLANATO PRESSATE A SECCO

Dry-pressed porcelain stoneware slabs . Dalles en grès cérame pressées à sec . Trocken gepresste Platten aus Feinsteinzeug.

GRES PORCELLANATO COLORATO IN MASSA

Full-body coloured porcelain stoneware / Grès cérame coloré dans la masse / In der Masse gefärbtes Feinsteinzeug.

CARATTERISTICA Specification Caracteristique Eigenschaft	NORMA Standards Norme Norm	RISULTATO PROVA Test results Resultats des essais Ergebnisse
 Classificazione prodotto Product classification Classification produit Produktklassifizierung	UNI EN 14411- Allegato G ISO 13006 UNI EN 14411- Appendix G ISO 13006 UNI EN 14411- Appendice G ISO 13006 UNI EN 14411- Anhang G ISO 13006	Gruppo B1a UGL Group B1a UGL Groupe B1a UGL Gruppe B1a UGL
 Caratteristiche dimensionali e d'aspetto Dimensional characteristics Caractéristiques dimensionnelles Abmessungen	UNI EN ISO 10545-2	Conforme alla norma. Complies with the standards. Conforme aux normes. Anforderungenerfüllt.
 Assorbimento di acqua Water absorption Absorption d'eau Wasseraufnahme	UNI EN ISO 10545-3	Conforme alla norma. Complies with the standards. Conforme aux normes. Anforderungenerfüllt.
 Resistenza alla flessione Breaking stress Résistance à la flexion Biegefestigkeit	UNI EN ISO 10545-4	Conforme alla norma. Complies with the standards. Conforme aux normes. Anforderungenerfüllt.
 Sforzo di rottura Breaking stress Effort de rupture Bruchkraft		Conforme alla norma. Complies with the standards. Conforme aux normes. Anforderungenerfüllt.
 Resistenza all'abrasione delle piastrelle non smaltate Deep abrasion resistance of unglazed tiles Résistance à l'abrasion profonde des carreaux non émaillés Beständig gegenüber Tiefenabrieb der unglasierten Fliesen	UNI EN ISO 10545-6	Secondo quanto dichiarato. As stated by the company. D'après déclaration de l'établissement. Entsprechend der Angaben des Unternehmens.
 Resistenza all'abrasione delle piastrelle smaltate Abrasion resistance of glazed tiles Résistance à l'abrasion des carreaux émaillés Abriebfestigkeit der glasierten Fliesen	UNI EN ISO 10545-7	-
 Dilatazione termica lineare Linear thermal expansion Dilatation thermique linéaire Lineare Wärmedehnung	UNI EN ISO 10545-8	7x10 ⁻⁶ C ⁻¹
 Resistenza agli sbalzi termici Thermal shock resistance Résistance aux écarts thermiques Beständigkeit gegenüber Temperaturschwankungen	UNI EN ISO 10545-9	Resistente. Resistant. Résiste. Erfüllt.
 Resistenza al cavillo Crazing resistance Résistance aux craquelures Beständigkeit gegenüber Glasurrisen	UNI EN ISO 10545-11	-
 Resistenza al gelo Frost resistance Résistance au gel Frostbeständigkeit	UNI EN ISO 10545-12	Resistente. Resistant. Résiste. Erfüllt.
 Resistenza ai prodotti chimici Chemical resistance Résistance aux produits chimiques Beständig gegenüber Chemikalien	UNI EN ISO 10545-13	Resistente. Resistant. Résiste. Erfüllt.
 Resistenza alle macchie Stain resistance Résistance aux taches Beständigkeit gegenüber Flecken	UNI EN ISO 10545-14	Resistente. Resistant. Résiste. Erfüllt.
 Stabilità dei colori alla luce Colour stability upon exposure to light Stabilité des couleurs à la lumière Stabilität der Farben gegenüber dem Licht	DIN 51094	Conforme alla norma. Complies with the standards. Conforme aux normes. Anforderungenerfüllt.
 Resistenza alla scivolosità Friction coefficient (slip level) Coefficient de friction (glissance) Reibungskoeffizient (Glätte)	DIN 51130	A richiesta. / Available on request. / Sur demande. / Anforderungenerfüllt.
	DIN 51097	A richiesta. / Available on request. / Sur demande. / Anforderungenerfüllt.
	B.C.R.A.-D.M. 236/89	A richiesta. / Available on request. / Sur demande. / Anforderungenerfüllt.
	DCOF (BOOT 3000 -section 9.6 ANSI 137.2012)	A richiesta. / Available on request. / Sur demande. / Anforderungenerfüllt.
 Resistenza al sale Salt resistance Résistance au sel Beständigkeit gegenüber Salz	NaCl	Resistente. Resistant. Résiste. Erfüllt.
 Resistenza al fuoco Reaction to fire Réaction au feu Brandschutz kaasse	UNI EN 13501-1-2009	A richiesta. Available on request. Sur demande. Anforderungenerfüllt.

Tagina S.p.A. si riserva di modificare, senza alcun preavviso, il packaging dei prodotti, le grafiche, i colori e i decori riportati nelle immagini che sono pertanto da ritenersi indicative.

Tagina S.p.A. reserves the right to change the product packaging, the patterns, colours and decorations shown in the pictures without any prior notice. These aspects, therefore should be considered for illustrative purposes only.

Tagina S.p.A. se réserve le droit de modifier, sans préavis, l'emballage des produits, les graphismes, les couleurs et les décors représentés dans les images, fournies à titre indicatif.

Die Tagina S.p.A. behält sich vor, die Verpackung der Produkte, die in den Abbildungen gezeigten Grafiken, Farben und Dekors sowie ohne vorherige Ankündigung zu ändern.

Follow us

Tagina
ITALY'S BEST SURFACES



Tagina S.p.A.
Via Emilia Ponente, 925
48014 Castel Bolognese (RA) - Italy
Tel. +39 0545 197 7303

tagina.it -  DAFIN GROUP

50
Anniversary
1973 | 2023



Grazie per la vostra cortese attenzione

Thank you for your kind attention
Merci pour votre aimable attention
Vielen Dank für Ihre freundliche Aufmerksamkeit

Scopri di più sul mondo Tagina

Find out more about Tagina's world
En savoir plus sur le monde Tagina
Erfahren Sie mehr über die Tagina-Welt