

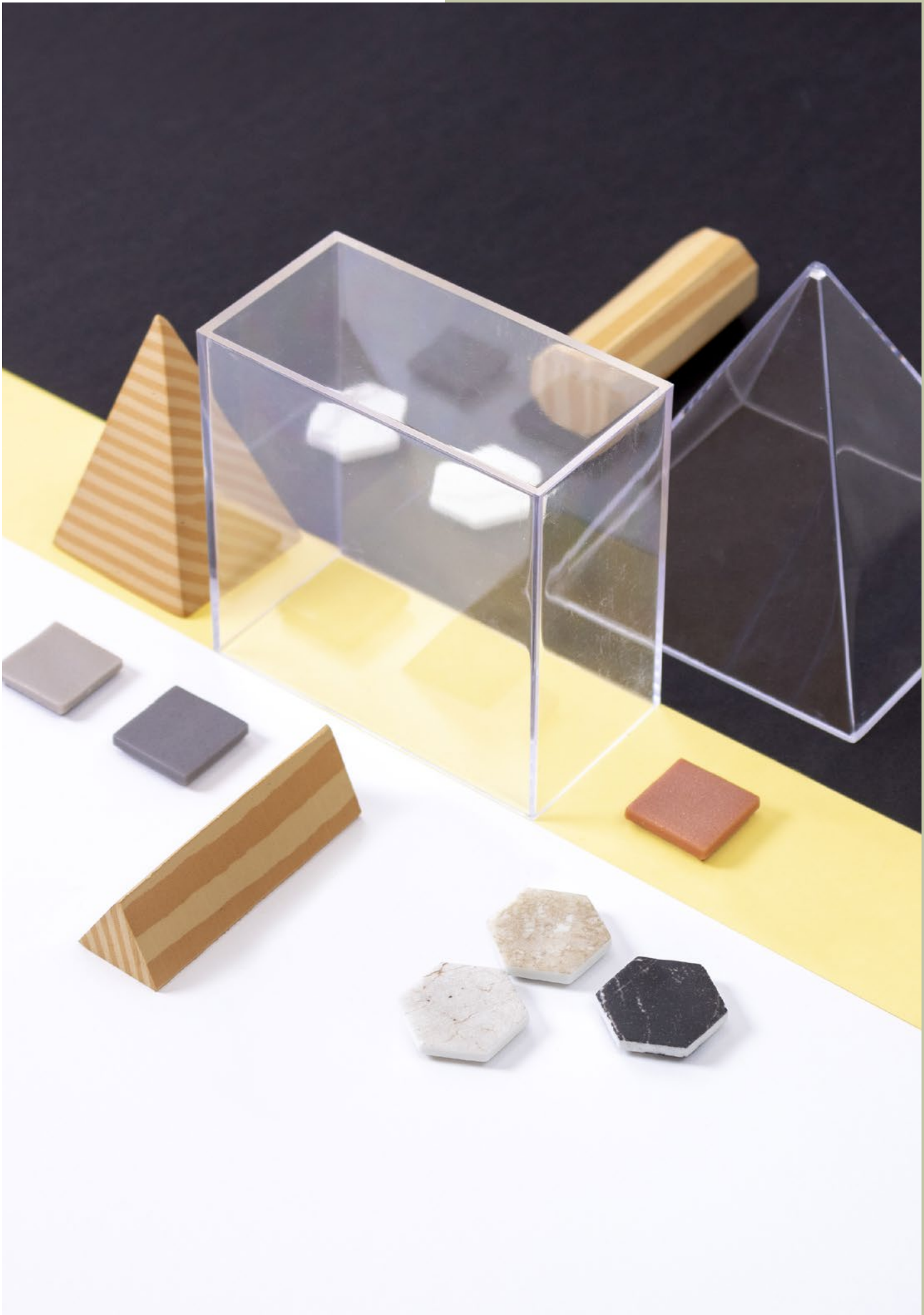

# ONIX<sup>®</sup>

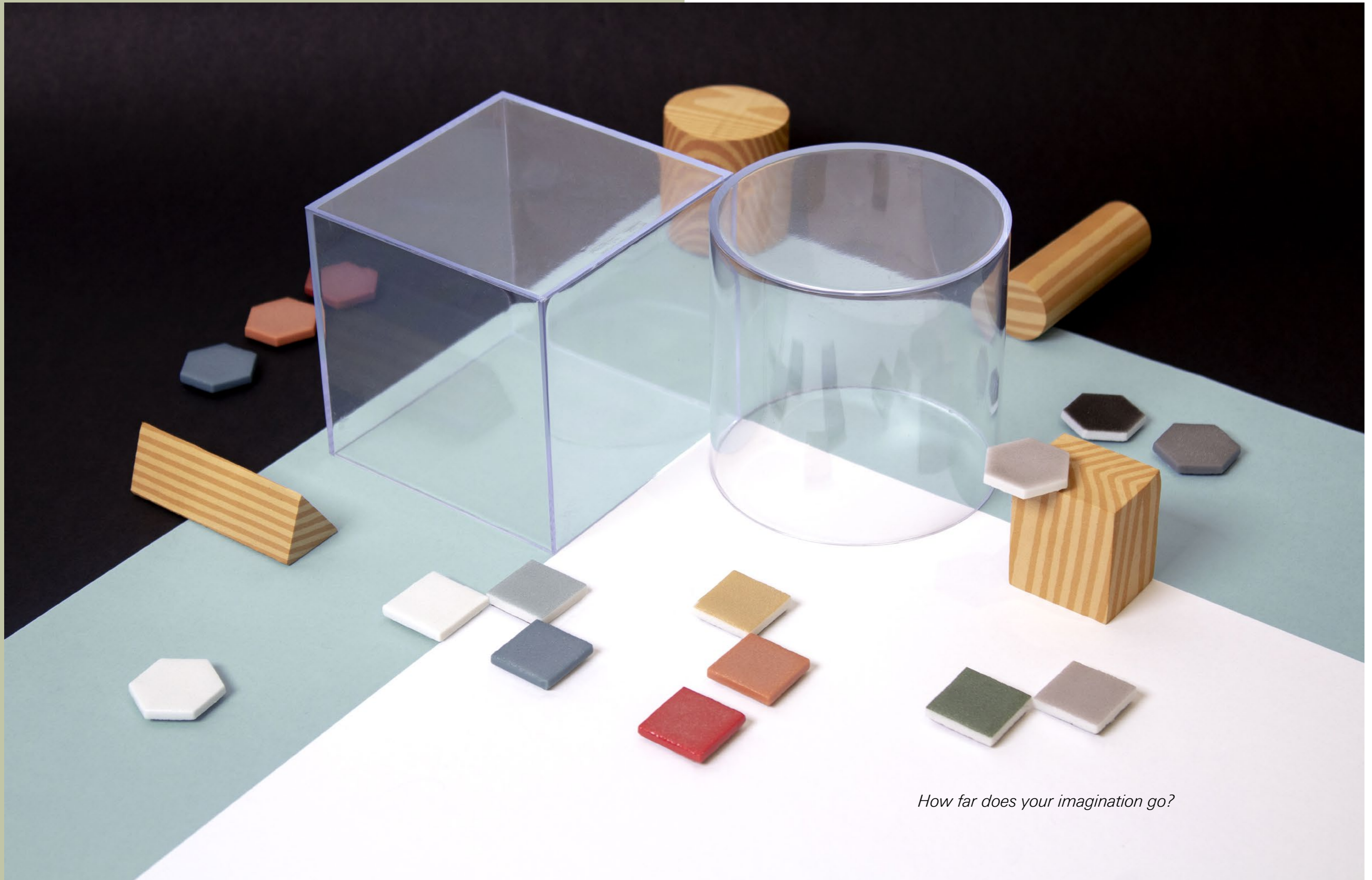









Geo Patterns &  
Custom Designs  
Catalogue 2020





*How far does your imagination go?*

Product

-  Minimum Order | 1 Module
-  Minimum Order | 1 Box
-  Sales Unit | Square Meters
-  Mosaic Support | Dots
-  Mosaic Support | Mesh
-  New Article
-  Gold 24k
-  Metals
-  Stoneglass Mohs 9
-  Antislip Article
-  Luminescent

Information

Collections



# HOW TO USE THE CATALOGUE

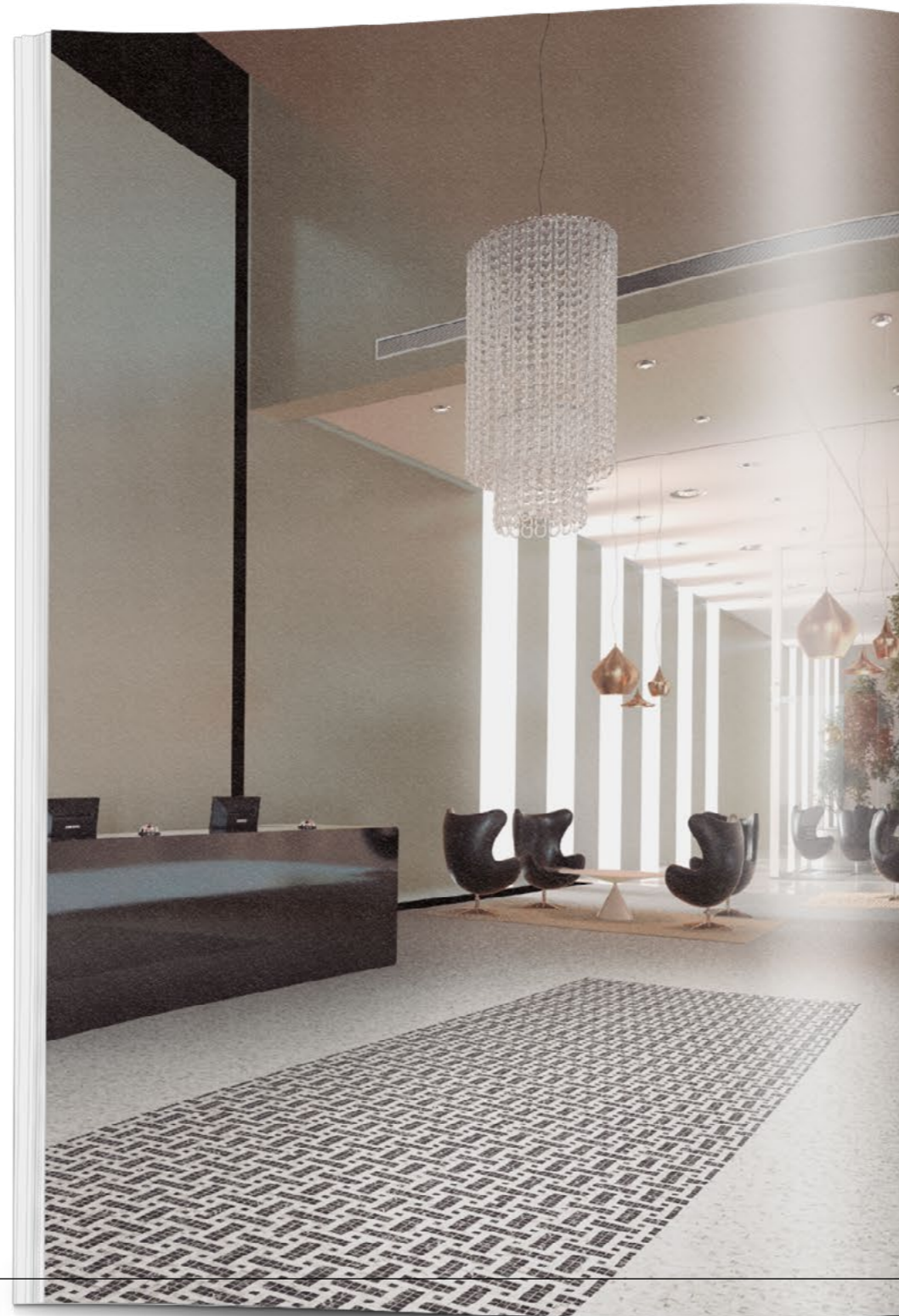

Name of the product  
Nombre del producto  
Nom du produit

|   |  |  |  |
|---|--|--|--|
| <p>Minimum order<br/>Pedido mínimo<br/>Commande minimum</p> | <p>Sales unit<br/>Unidad de venta<br/>Unité de vente</p> | <p>Support mosaic<br/>Soporte mosaico<br/>Support mosaïque</p> | <p>Tesserae format<br/>Formato de la tesela<br/>Format de tesselle</p> |
|---|--|--|--|

|   |   |
|---|---|
| <p>GEO PATTERNS</p>   | <p>Name of the series<br/>Nombre de la serie<br/>Nom de la serie</p>                                  |
|   | <p>Price code<br/>Código de venta<br/>Code prix</p>   |
| <p>2003357 Squares Pattern 1<br/>New Marquina Matrix, Venato White Marble 473</p>   | <p>Code article and description<br/>Código artículo y descripción<br/>Code article et description</p> |
| <p>repeated module</p> <p>Sheet 4.9 mm - 0.19" Thickness<br/>Box 5 Sheets</p> <p>250x250 mm - 10.10"x10.10"<br/>0.35 m<sup>2</sup> - 3.77 sqft 0.07 m<sup>2</sup></p> | <p>Packing<br/>Embalaje<br/>Emballage</p>   |
|   | <p>2176487 Squares Pattern 2<br/>New Marquina Matrix, Venato White Marble, Shiny Gloss 473</p>        |
| <p>repeated module</p> <p>Sheet 4.9 mm - 0.19" Thickness<br/>Box 6 Sheets</p> <p>250x250 mm - 10.10"x10.10"<br/>0.35 m<sup>2</sup> - 3.77 sqft 0.07 m<sup>2</sup></p> | <p>GEO PATTERNS 48</p>  |
|   | <p>2176488 Squares Pattern 3<br/>New Marquina Matrix, Venato White Marble, Shiny Gloss 473</p>        |
| <p>repeated module</p> <p>Sheet 4.9 mm - 0.19" Thickness<br/>Box 5 Sheets</p> <p>315x315 mm - 12.24"x12.24"<br/>0.49 m<sup>2</sup> - 5.27 sqft 0.10 m<sup>2</sup></p> |   |





Web App optimized for desktop computer or tablet. Not recommended for smartphone devices.

*Choose from over 50 different designs in SQUARE, HEX and PENTA formats. Customize each one with our Mosaic Creator web app.*



# MOSAIC CREATOR

There are three different options to choose or to create your own Geopattern.

## 1. Existing standard designs with predefined mosaics.

Choose an existing design with default mosaics from this catalogue or our website.

Elige un diseño existente con productos predeterminados de este catálogo o de nuestra web.

Faites votre choix parmi les designs existant avec des produits prédéterminés dans ce catalogue ou sur notre site internet.

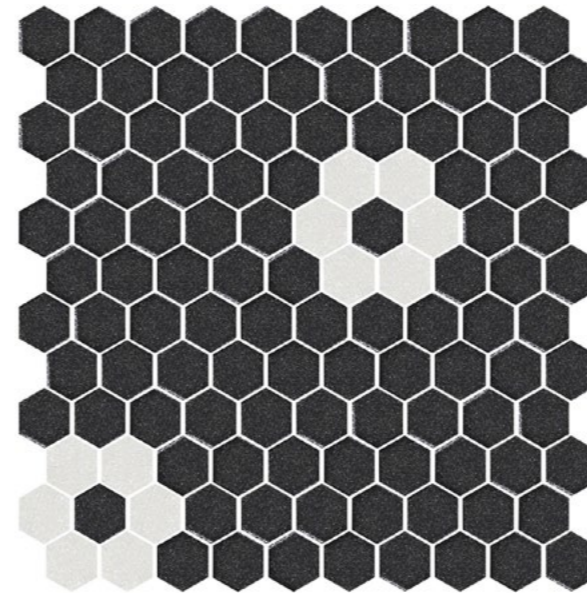

Hex Natureglass White, Black.

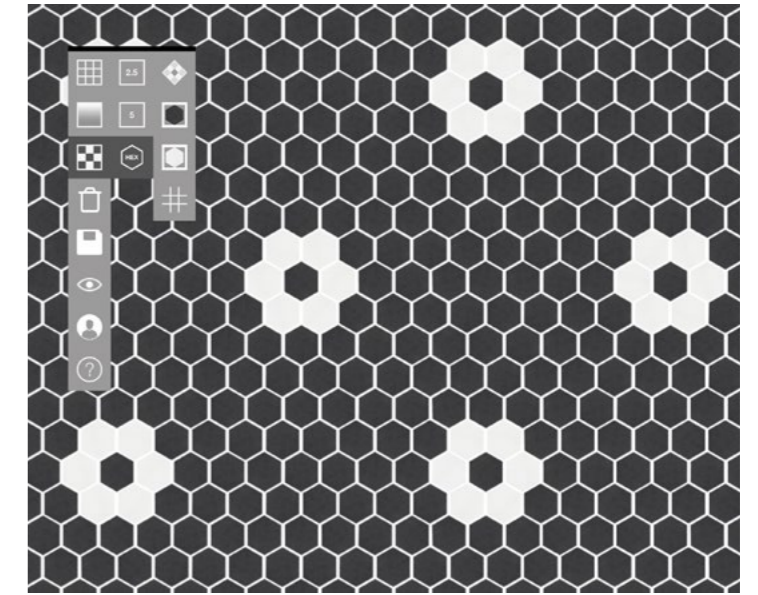

Standard design | Mosaic Creator.

## 2. Customized colors and finishes using existing standard designs.

Access the Mosaic Creator web application; choose an existing pattern, and change series, finishes and colors to customize it.

Accede a la aplicación web Mosaic Creator y escoge un pattern existente, modifica sus acabados y colores hasta crear tu propio Pattern.

Accédez à notre application Web Mosaic Creator et choisissez un Pattern existant, changez ses finitions et couleurs pour créer votre propre Pattern.



Hex Natureglass Dark Grey, Hex Silver Matte.

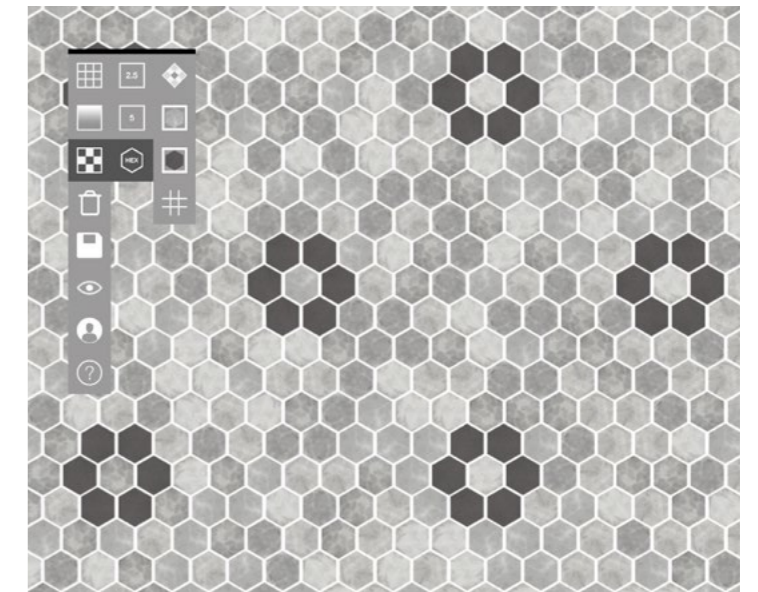

Customized design | Mosaic Creator.

## 3. New custom designs.

If you wish to create a totally new design, send us your proposal with a selection of products you want to include and we will design the custom Geo Pattern for you.

Si quieres crear un diseño totalmente nuevo, envíanos tu propuesta y la selección de productos que quieres incluir y elaboraremos un pattern a tu medida.

Si vous souhaitez créer un tout nouveau design, envoyez-nous votre proposition avec la sélection de produits que vous souhaitez inclure et nous pourrons créer un Geo Pattern personnalisé.



Hex Natureglass White, Black, Hex Stoneglass Ochre.

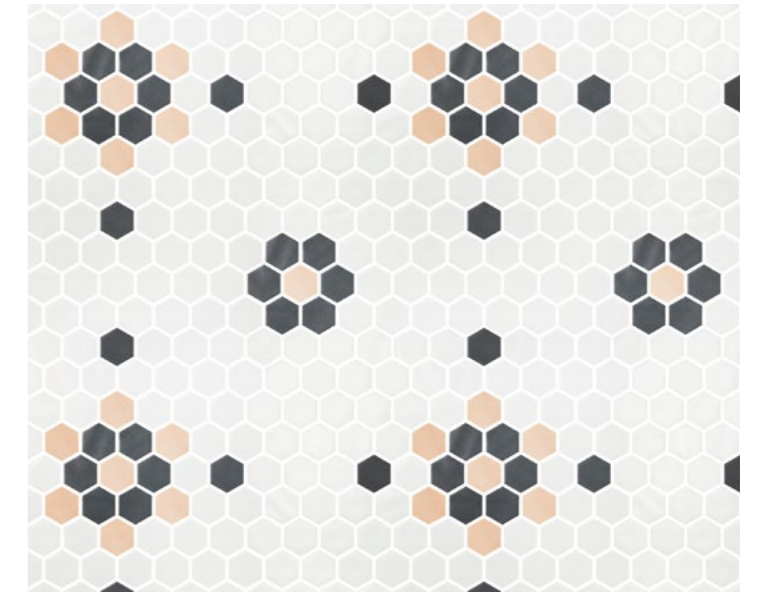

Your design.



## MOSAIC FINISHES

Tesserae from each range hold different colours and technical specs. You can mix them and create as many combinations as you wish.

Cada tipología de tesela tiene unos acabados, colores y cualidades técnicas. Puedes mezclarlas entre sí y crear tantas combinaciones como necesites.

Chaque tesselle a des finitions, des couleurs et des qualités techniques différentes. Vous pouvez les mélanger et créer autant de combinaisons que vous le souhaitez.

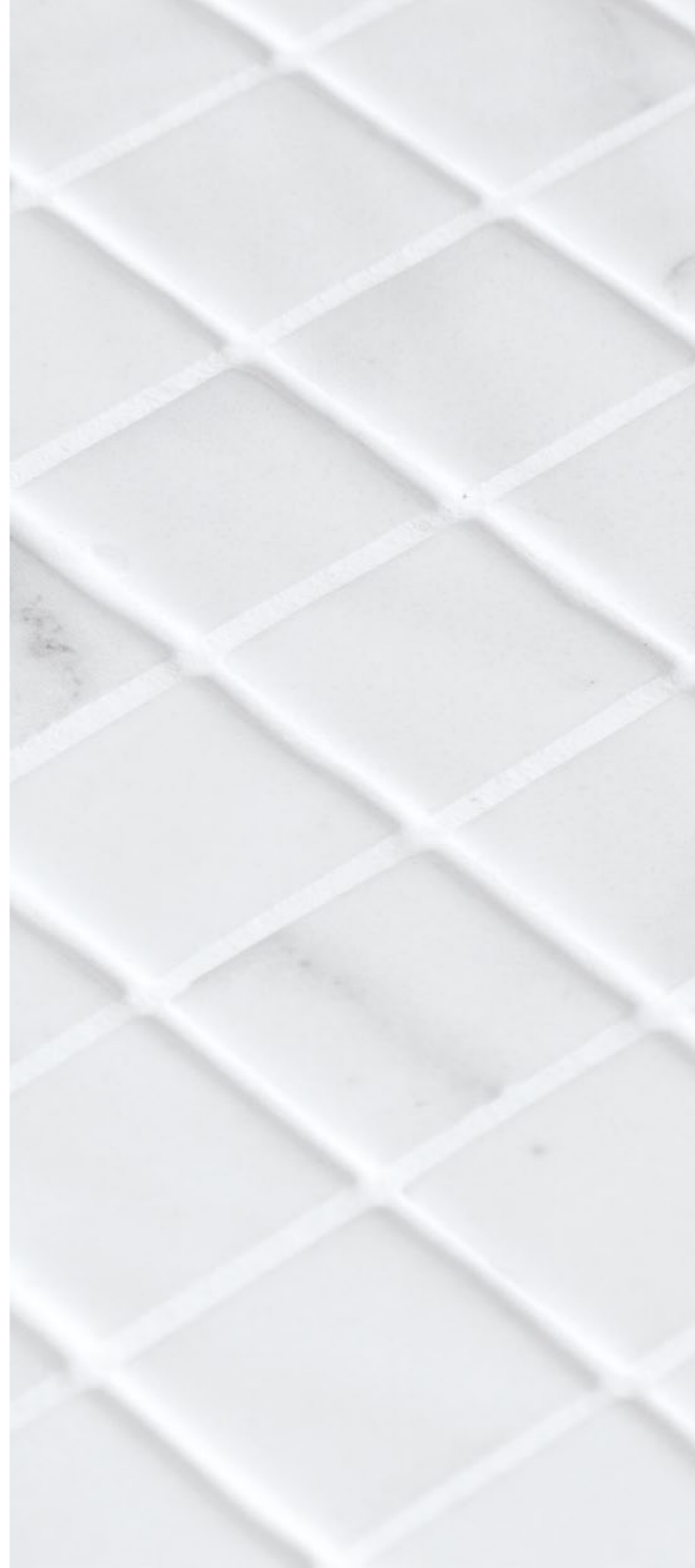

### Ecstones.

A delicate look with an anti-slip feature (C3/R11).

Un look delicado, pero con su cualidad antideslizante intacta (C3/R11).

Un look délicat avec une propriété anti-slip (C3/R11).

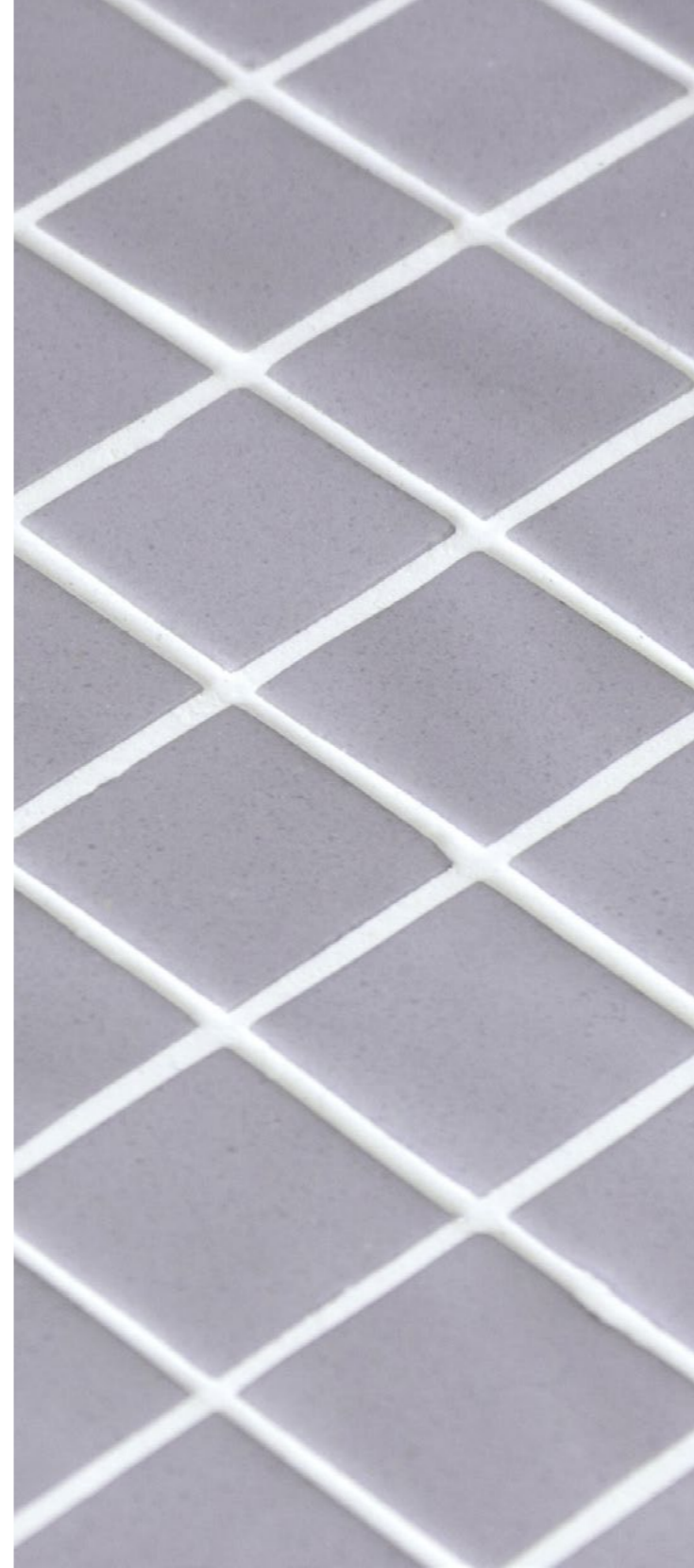

### Natureglass.

Matte finish for wall cladding or residential flooring.

Acabado mate perfecto para revestimientos o suelos residenciales.

Finition mate pour revêtement ou sols à usage privé.



### Stoneglass.

StoneGlass is the hardest mosaic in the world, especially suitable for non-slip commercial flooring.

StoneGlass es el mosaico más duro del mundo, este mosaico está especialmente indicado para pavimentos comerciales.

StoneGlass est la mosaïque la plus dure du monde, Cette mosaïque est particulièrement adaptée aux zones de grand passage.



# STONEGLASS PALETTE

MOHS 9  
C2 / R9

TRAFFIC  
AREAS

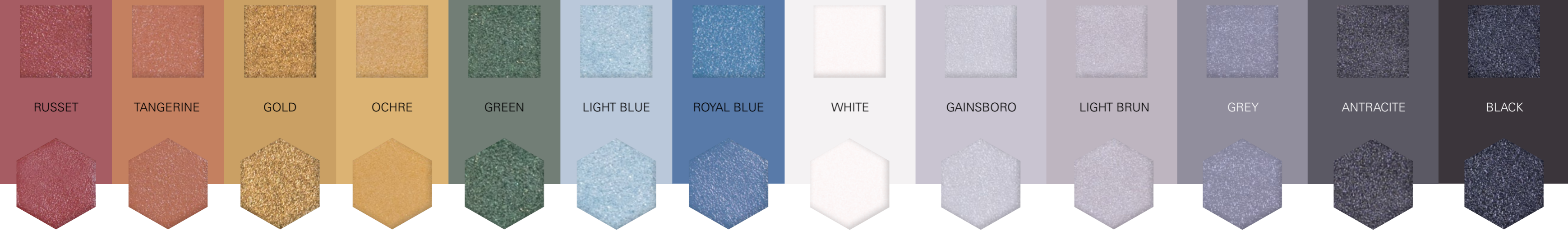

RUSSET

TANGERINE

GOLD

OCHRE

GREEN

LIGHT BLUE

ROYAL BLUE

WHITE

GAINSBORO

LIGHT BRUN

GREY

ANTRACITE

BLACK

Onix's highest technical spec range that stands out for its high wear resistance. Classed Mohs 9 (almost as hard as diamond mosaic) it's especially suitable for non-slip commercial flooring.

La serie más técnica de Onix. Una proeza de producción que destaca por su alta resistencia al desgaste. Catalogado como Mohs 9, es casi tan duro como el diamante, este mosaico está especialmente indicado para pavimentos comerciales antideslizantes.

La série la plus technique d'Onix. Un exploit de production qui se distingue par une haute résistance à l'usure. Classé Mohs 9, elle est presque aussi dure que le diamant, particulièrement adaptée aux zones de grand passage.

# NATUREGLASS PALETTE

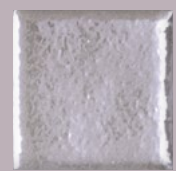

ARGENT

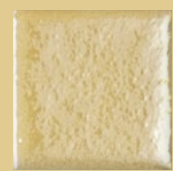

GOLDEN



BONE



TANGERINE

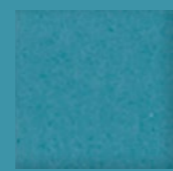

TURQUOISE



ROYAL BLUE

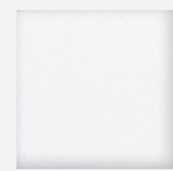

WHITE

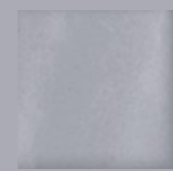

SMOOTH GREY

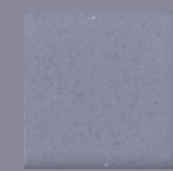

GREY



DARK GREY

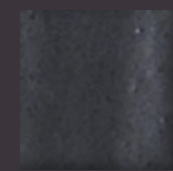

BLACK

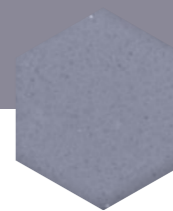
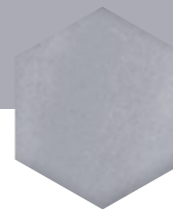
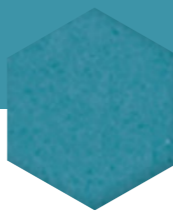
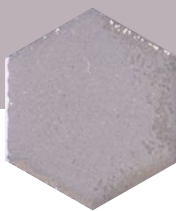

The mosaic of great technical perfection. Tesserae with a defined cut and a neat matte finish. The base is coloured in a great variety of hues and shades: White, off-white, black, grey, silver, gold...

El mosaico de mayor perfección técnica. Teselas toda masa con corte totalmente definido y un pulcro acabado mate. La base está coloreada en una gran variedad de tonos y matices: Blanco, hueso, negro, grises, plata, dorado...

La mosaïque la plus aboutie techniquement. Des tesselles avec une coupe entièrement définie et une finition mate soignée. La base est colorée dans une grande variété de tonalités et de nuances: blanc, blanc cassé, noir, gris, argent, or...

# ECOSTONES PALETTE

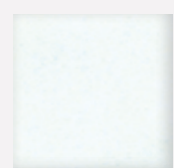

VENATO  
WHITE

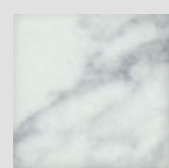

STATUARIO

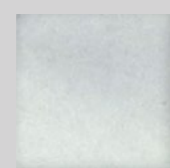

CALACATTA

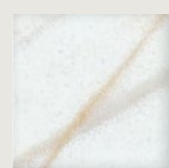
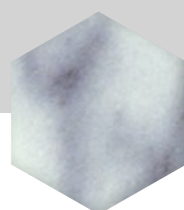

CALACATTA  
GOLD

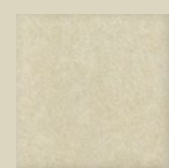

NEW  
LIMESTONE



CREMA  
MARFIL

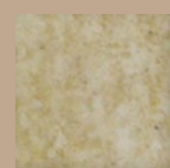

ECRU

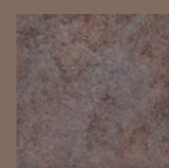

NEW SLATE



IVORY HONED

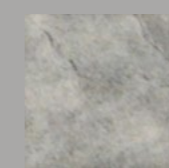

SILVER

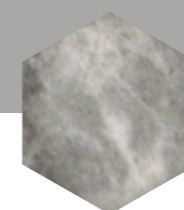

GRAFITO

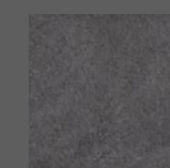
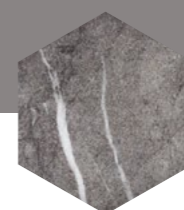

NEW BASALT

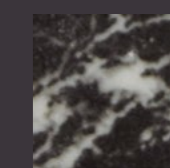

NERO  
MARQUINA

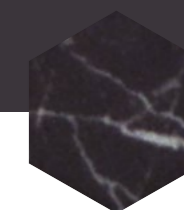

Elegant marble and stone textures cover each mosaic. Endless possibilities of combination for decorating environments. A grain that recalls the marble fineness and recreates stone, taking us to its natural origin.

Elegantes texturas con mármoles y piedras recubren cada mosaico. Posibilidades infinitas de combinación para ambientes de decoración. Un vetado que recuerda la finura mármol y recrea con realismo las piedras y nos traslada a su origen natural.

Des textures élégantes en marbre et en pierre couvrent chaque mosaïque. Les possibilités de combinaison sont infinies pour les environnements de décoration. Un grain qui évoque la finesse du marbre et recrée d'une façon réelle les pierres en nous amenant à son origine naturelle.





# HEX

COLLECTION





# HEX GEO PATTERNS



**2003002 Hex Pattern 1** 530  
Hex Natureglass White, Black.

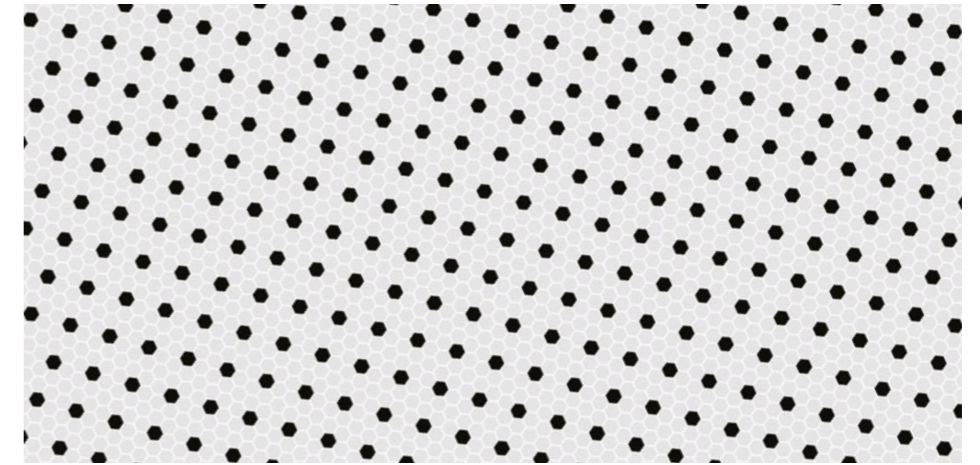

*Repeated module* Sheet 4,4 mm - 0.173" Thickness 232x301 mm - 9.13"x11.85" 0,07 m²  
Box 6 Sheets 0,42 m² - 4.52 sqft

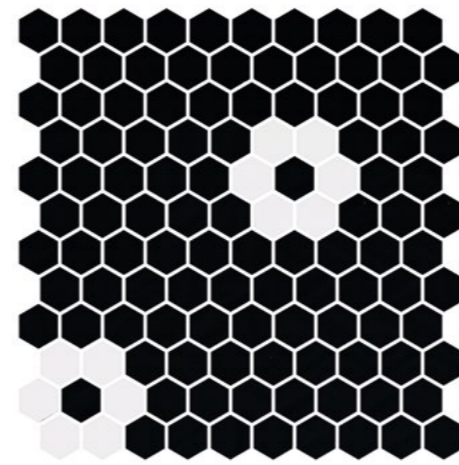

**2003363 Hex Pattern 2** 530  
Hex Natureglass Black, White.

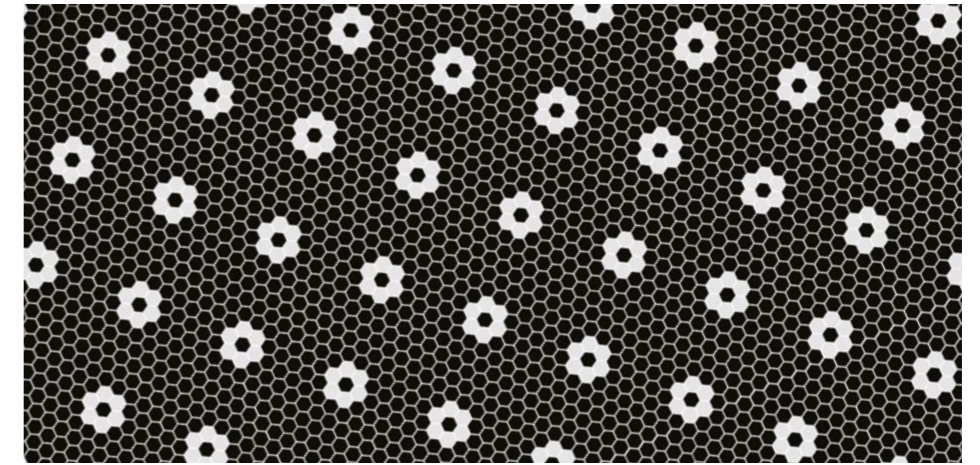

*Repeated module* Sheet 4,4 mm - 0.173" Thickness 290x301 mm - 11.41"x11.85" 0,09 m²  
Box 6 Sheets 0,53 m² - 5.70 sqft

Hex Pattern 1



# HEX GEO PATTERNS



**2003364 Hex Pattern 3** 530  
Hex Stoneglass White, Ochre, Gainsboro, Antracite.

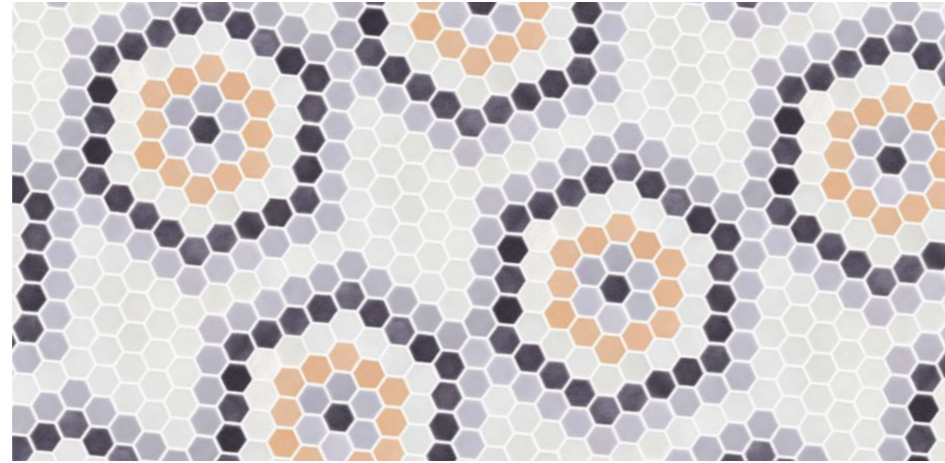

*Repeated module*  
Sheet 4,4 mm - 0.173" Thickness 290x301 mm - 11.41"x11.85" 0,09 m<sup>2</sup>  
Box 6 Sheets 0,53 m<sup>2</sup> - 5.70 sqft



**2003365 Hex Pattern 4** 530  
Hex Nero Marquina Matte, Hex Venato White Matte, Hex Silver Matte.

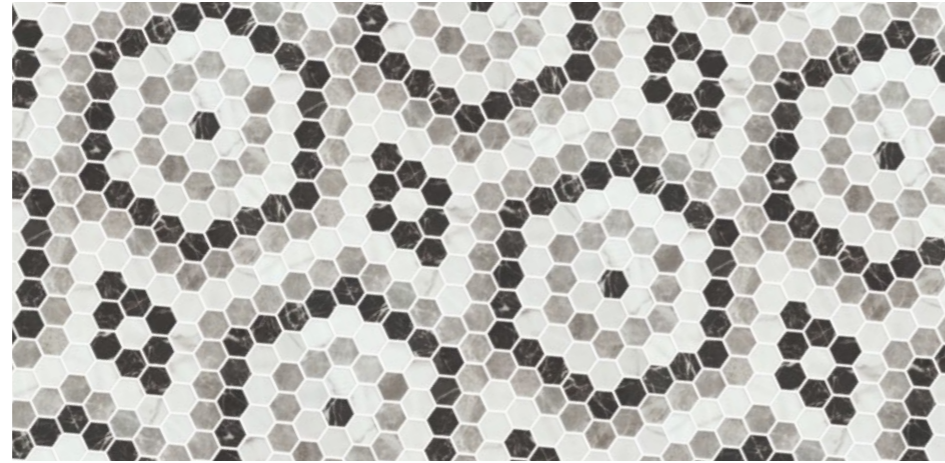

*Repeated module*  
Sheet 4,4 mm - 0.173" Thickness 290x301 mm - 11.41"x11.85" 0,09 m<sup>2</sup>  
Box 6 Sheets 0,53 m<sup>2</sup> - 5.70 sqft



**2003366 Hex Pattern 5** 530  
Hex Stoneglass White, Green, Gainsboro.

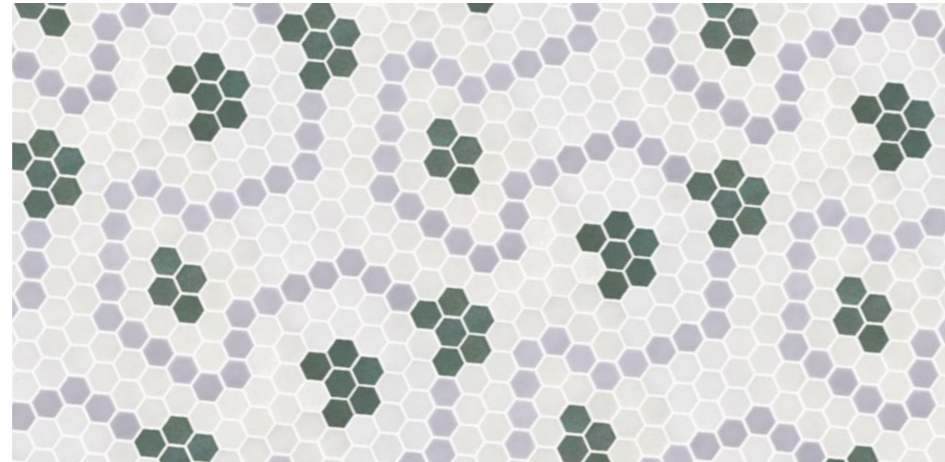

*Repeated module*  
Sheet 4,4 mm - 0.173" Thickness 290x301 mm - 11.41"x11.85" 0,09 m<sup>2</sup>  
Box 6 Sheets 0,53 m<sup>2</sup> - 5.70 sqft



Hex Pattern 4



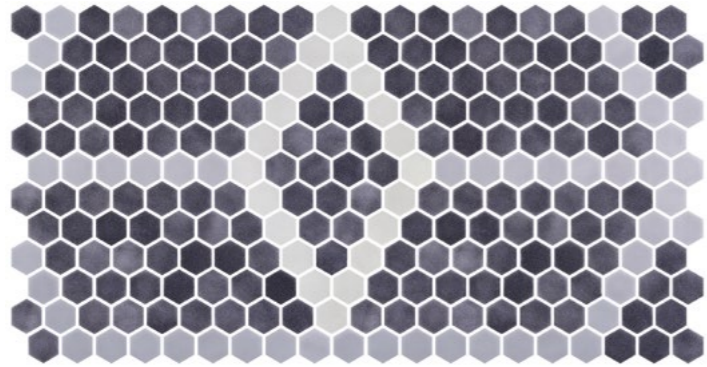

**2004334 Hex Pattern 12** 530  
Hex Stoneglass White, Gainsboro, Antracite.

|       |                           |                                 |                      |
|-------|---------------------------|---------------------------------|----------------------|
| Sheet | 4,4 mm - 0.173" Thickness | 580x301 mm - 22.83"x11.85"      | 0,175 m <sup>2</sup> |
| Box   | 6 Sheets                  | 0,53 m <sup>2</sup> - 5.70 sqft |                      |

Repeated module

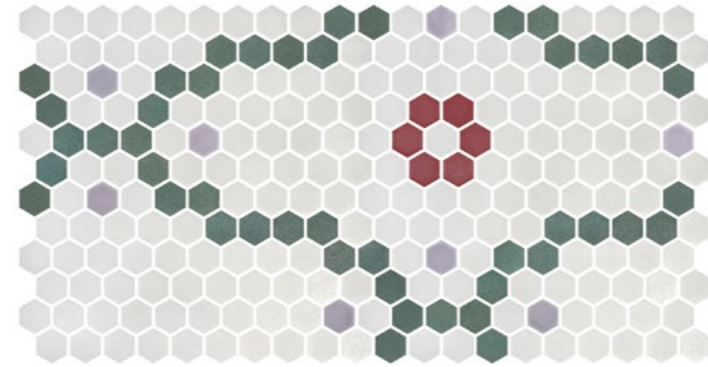
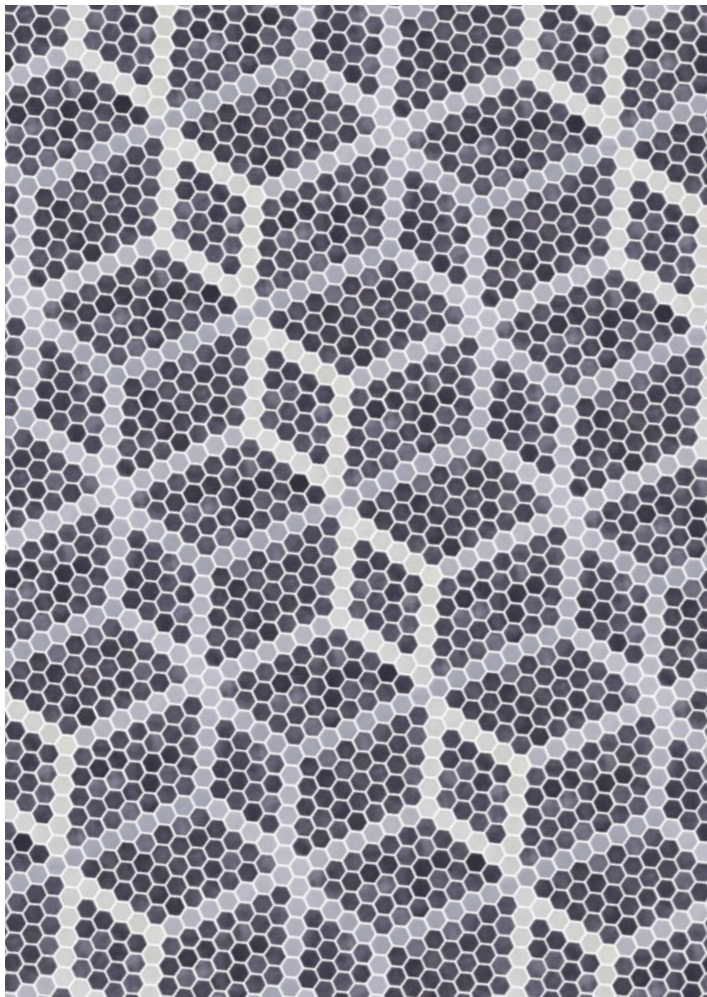

**2004335 Hex Pattern 13** 530  
Hex Stoneglass White, Light Brun, Russet, Green.

|       |                           |                                 |                      |
|-------|---------------------------|---------------------------------|----------------------|
| Sheet | 4,4 mm - 0.173" Thickness | 580x301 mm - 22.83"x11.85"      | 0,175 m <sup>2</sup> |
| Box   | 6 Sheets                  | 0,53 m <sup>2</sup> - 5.70 sqft |                      |

Repeated module



**2004336 Hex Pattern 14** 530  
Hex Stoneglass White, Light Blue, Royal Blue.

|       |                           |                                 |                      |
|-------|---------------------------|---------------------------------|----------------------|
| Sheet | 4,4 mm - 0.173" Thickness | 261x452 mm - 10.27"x17.79"      | 0,118 m <sup>2</sup> |
| Box   | 10 Sheets                 | 0,59 m <sup>2</sup> - 6.35 sqft |                      |

Repeated module



**2004337 Hex Pattern 15** 530  
Hex Stoneglass White, Green, Ochre.

|       |                           |                                 |                      |
|-------|---------------------------|---------------------------------|----------------------|
| Sheet | 4,4 mm - 0.173" Thickness | 290x602 mm - 11.41"x 23.70"     | 0,175 m <sup>2</sup> |
| Box   | 6 Sheets                  | 0,35 m <sup>2</sup> - 3.77 sqft |                      |

Repeated module

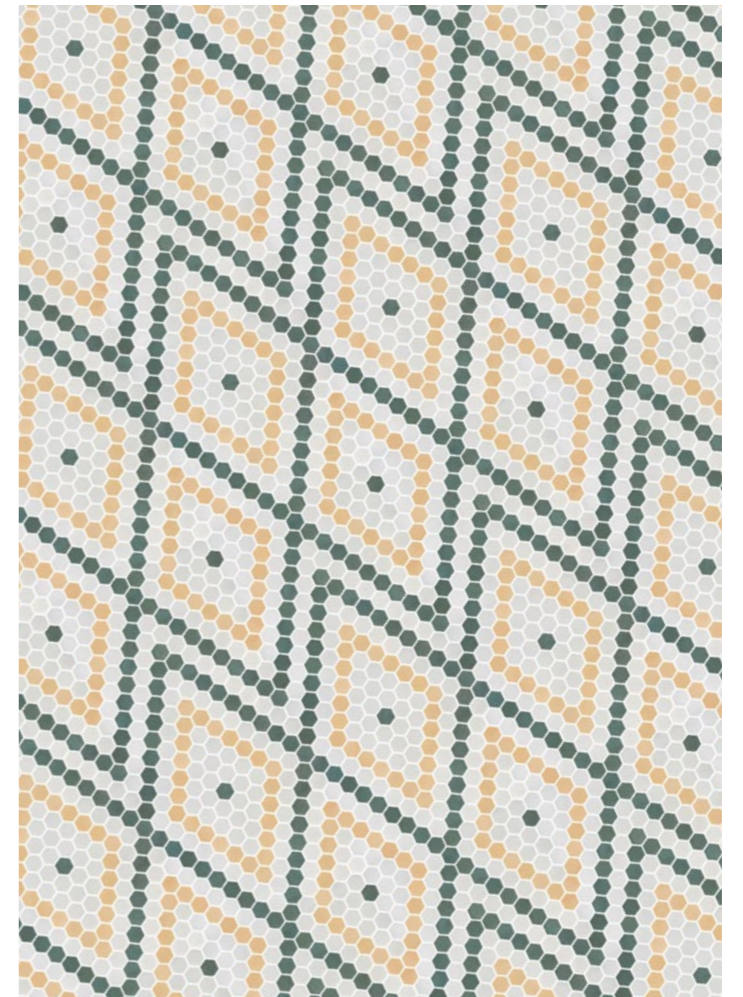



# HEX GEO PATTERNS

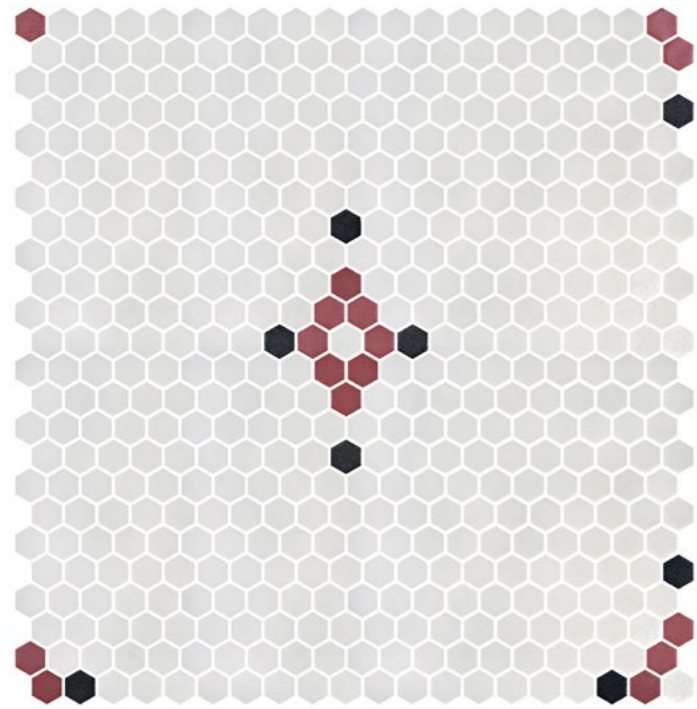

**2004340 Hex Pattern 18** 530  
Hex Stoneglass White, Black, Russet.

|       |                           |                                 |                     |
|-------|---------------------------|---------------------------------|---------------------|
| Sheet | 4,4 mm - 0.173" Thickness | 580x602 mm - 22.83"x23.70"      | 0,35 m <sup>2</sup> |
| Box   | 4 Sheets                  | 0,35 m <sup>2</sup> - 3.77 sqft |                     |

Repeated module

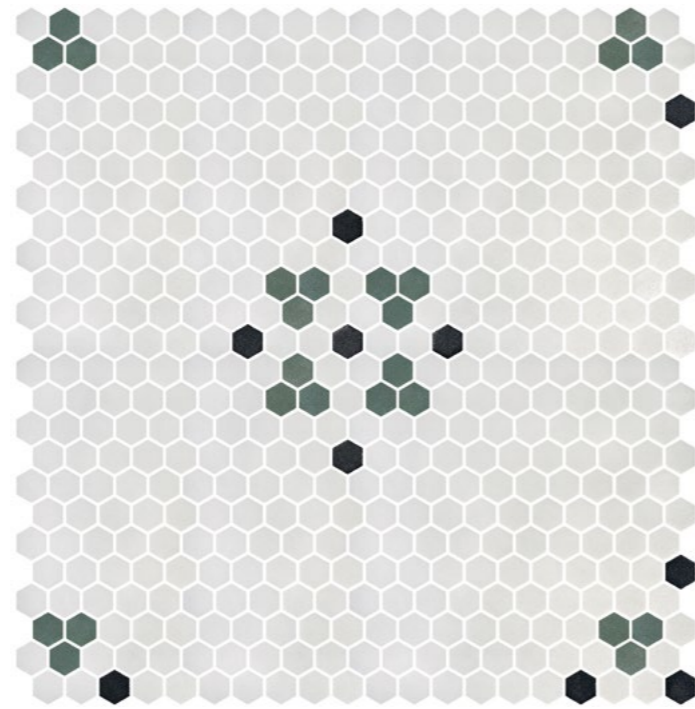
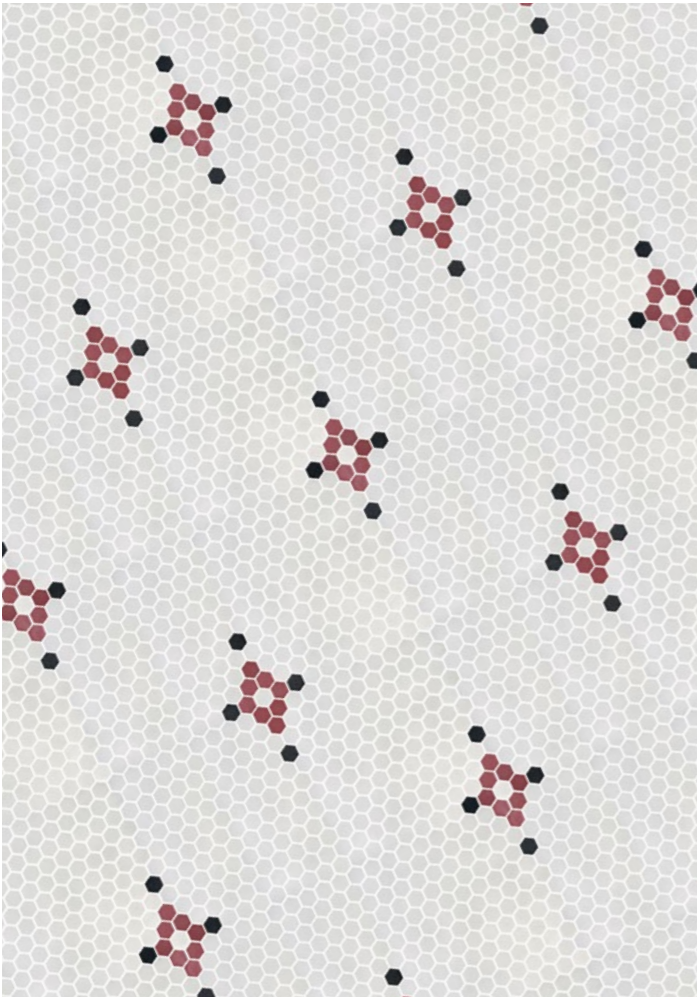

**2004338 Hex Pattern 16** 530  
Hex Stoneglass White, Black, Green.

|       |                           |                                 |                     |
|-------|---------------------------|---------------------------------|---------------------|
| Sheet | 4,4 mm - 0.173" Thickness | 580x602 mm - 22.83"x23.70"      | 0,35 m <sup>2</sup> |
| Box   | 4 Sheets                  | 0,35 m <sup>2</sup> - 3.77 sqft |                     |

Repeated module

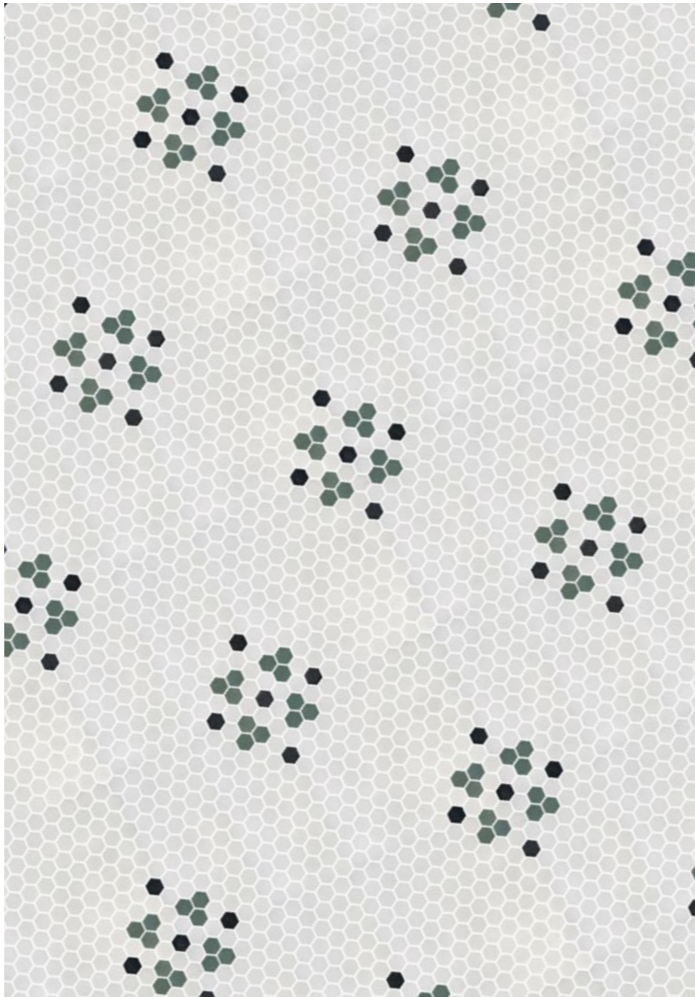

Hex Pattern 18







**2003640 Hex Pattern 8** 530  
Hex Natureglass White, Smooth Grey, Black.

|       |                           |                            |         |
|-------|---------------------------|----------------------------|---------|
| Sheet | 4,4 mm - 0.173" Thickness | 580x602 mm - 22.83"x23.70" | 0,35 m² |
| Box   | 4 Sheets                  | 0,35 m² - 3.77 sqft        |         |

Repeated module

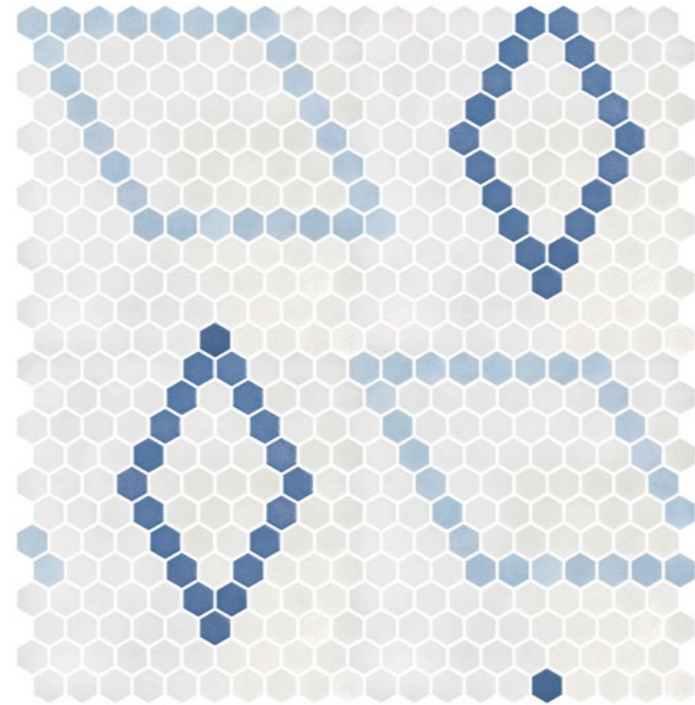

**2003641 Hex Pattern 9** 530  
Hex Stoneglass White, Light Blue, Royal Blue.

|       |                           |                            |         |
|-------|---------------------------|----------------------------|---------|
| Sheet | 4,4 mm - 0.173" Thickness | 580x602 mm - 22.83"x23.70" | 0,35 m² |
| Box   | 4 Sheets                  | 0,35 m² - 3.77 sqft        |         |

Repeated module

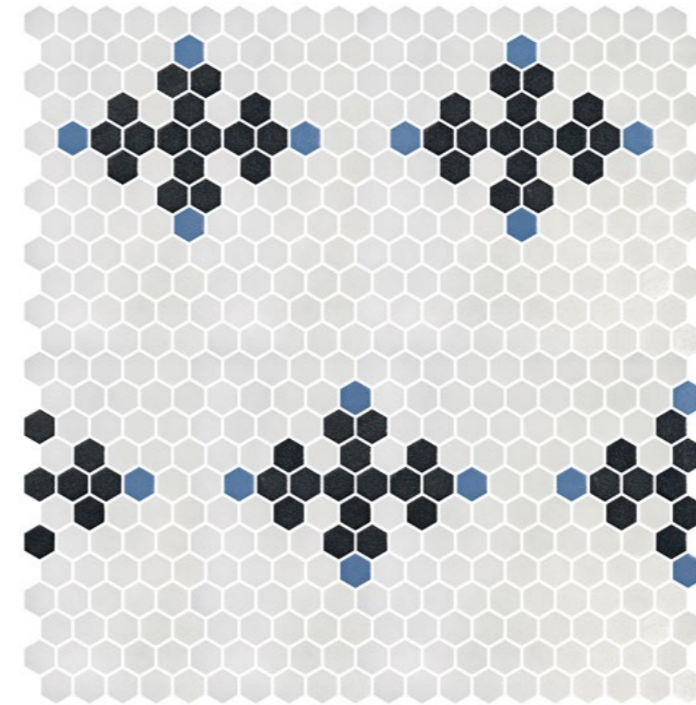

**2004339 Hex Pattern 17** 530  
Hex Stoneglass White, Black, Royal Blue.

|       |                           |                            |         |
|-------|---------------------------|----------------------------|---------|
| Sheet | 4,4 mm - 0.173" Thickness | 580x602 mm - 22.83"x23.70" | 0,35 m² |
| Box   | 4 Sheets                  | 0,35 m² - 3.77 sqft        |         |

Repeated module





# HEX GEO PATTERNS



**2003642 Hex Pattern 10** 530  
Hex Ivory Honed, Hex Stoneglass Ochre.

Sheet 4,4 mm - 0.173" Thickness 580x602 mm - 22.83"x23.70" 0,35 m<sup>2</sup>  
Box 4 Sheets 0,35 m<sup>2</sup> - 3.77 sqft

Repeated module

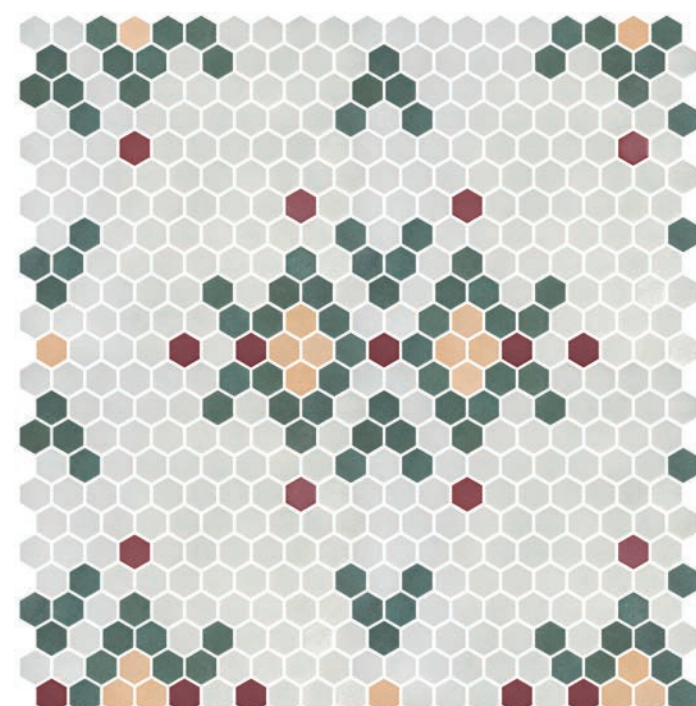

**2004342 Hex Pattern 20** 530  
Hex Stoneglass White, Russet, Green, Ochre.

Sheet 4,4 mm - 0.173" Thickness 580x602 mm - 22.83"x23.70" 0,35 m<sup>2</sup>  
Box 4 Sheets 0,35 m<sup>2</sup> - 3.77 sqft

Repeated module

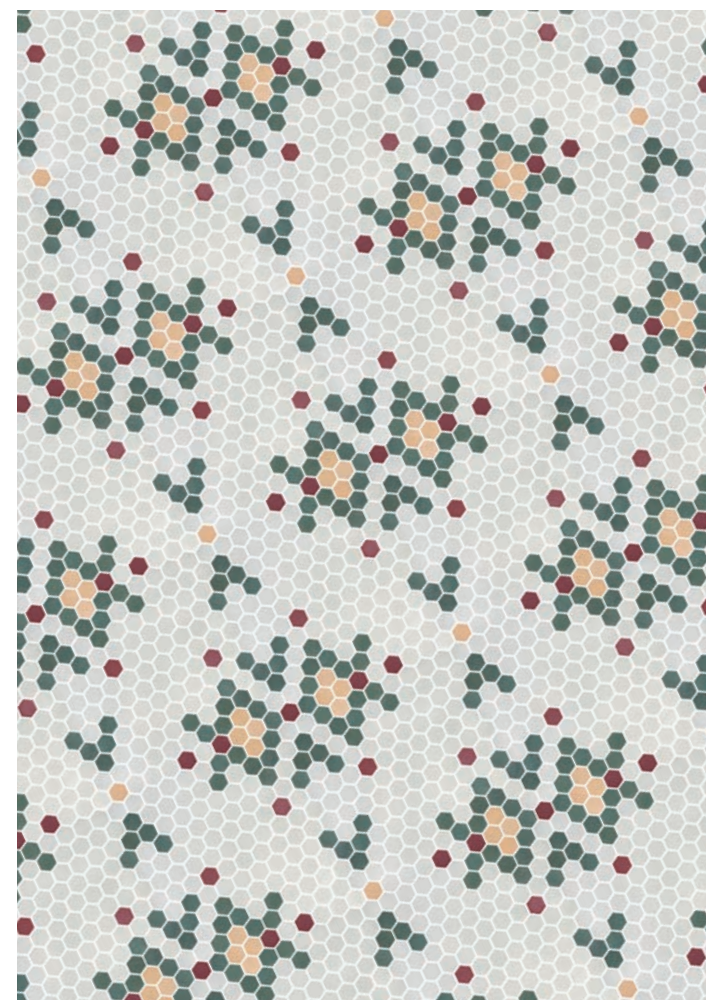

Hex Pattern 10



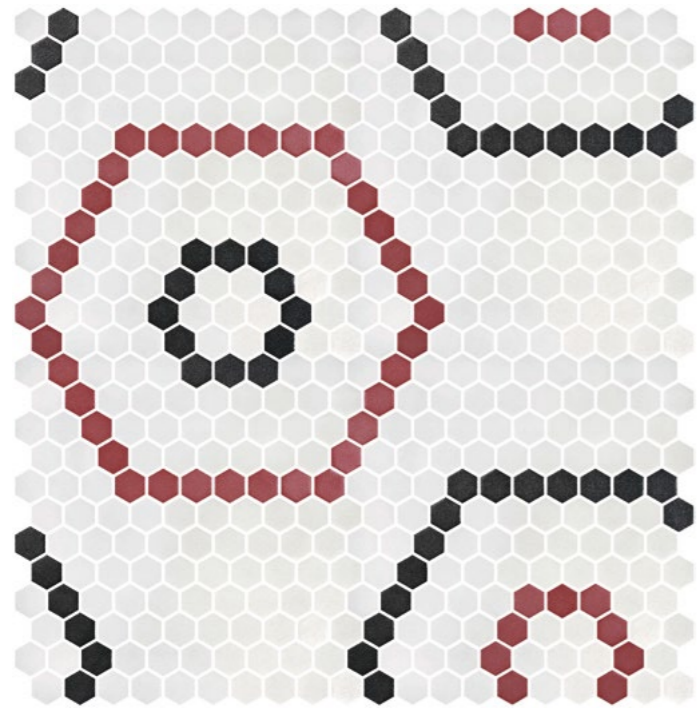

**2003369 Hex Pattern 7** 530  
Hex Stoneglass White, Black, Russet.

|       |                           |                            |         |
|-------|---------------------------|----------------------------|---------|
| Sheet | 4,4 mm - 0.173" Thickness | 580x602 mm - 22.83"x23.70" | 0,35 m² |
| Box   | 4 Sheets                  | 0,35 m² - 3.77 sqft        |         |

Repeated module

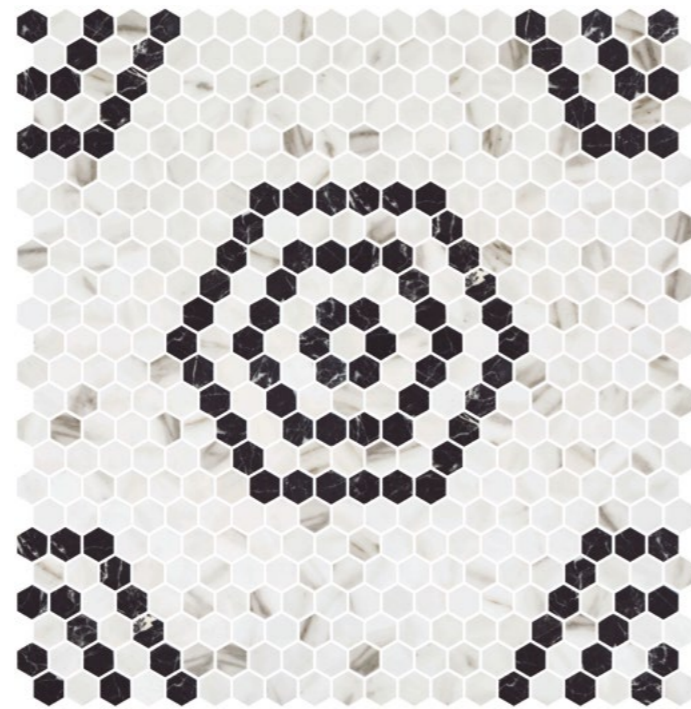

**2003367 Hex Pattern 6** 530  
Hex Nero Marquina Matte, Hex Calacatta Matte.

|       |                           |                            |         |
|-------|---------------------------|----------------------------|---------|
| Sheet | 4,4 mm - 0.173" Thickness | 580x602 mm - 22.83"x23.70" | 0,35 m² |
| Box   | 4 Sheets                  | 0,35 m² - 3.77 sqft        |         |

Repeated module

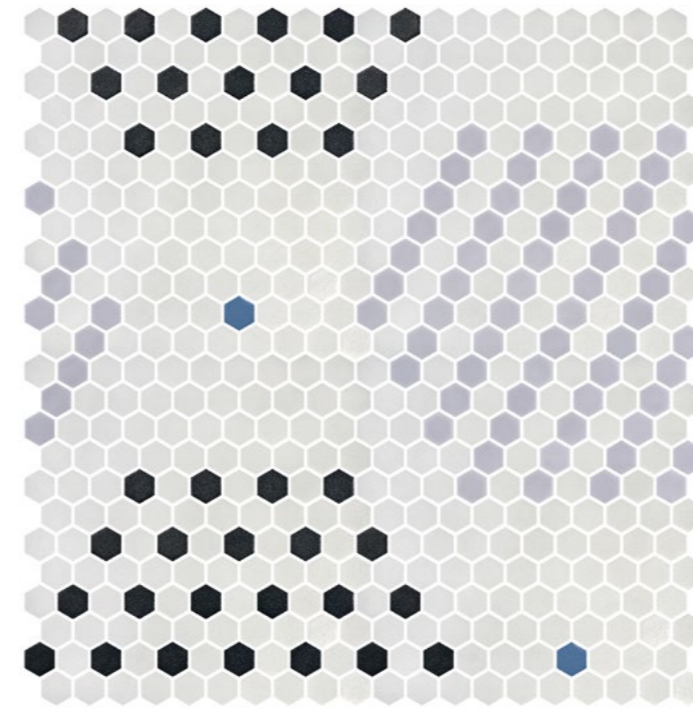

**2004344 Hex Pattern 22** 530  
Hex Stoneglass White, Gainsboro, Black, Royal Blue.

|       |                           |                            |         |
|-------|---------------------------|----------------------------|---------|
| Sheet | 4,4 mm - 0.173" Thickness | 580x602 mm - 22.83"x23.70" | 0,35 m² |
| Box   | 4 Sheets                  | 0,35 m² - 3.77 sqft        |         |

Repeated module

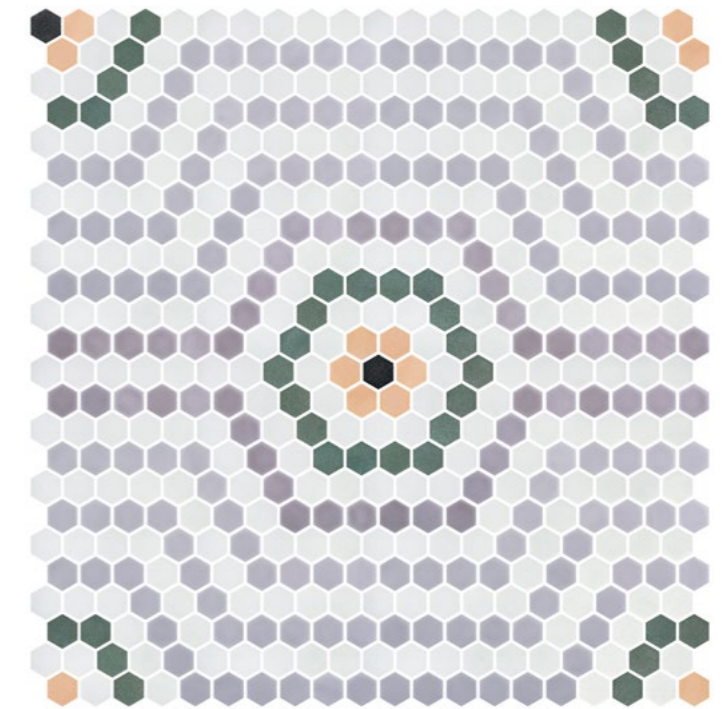
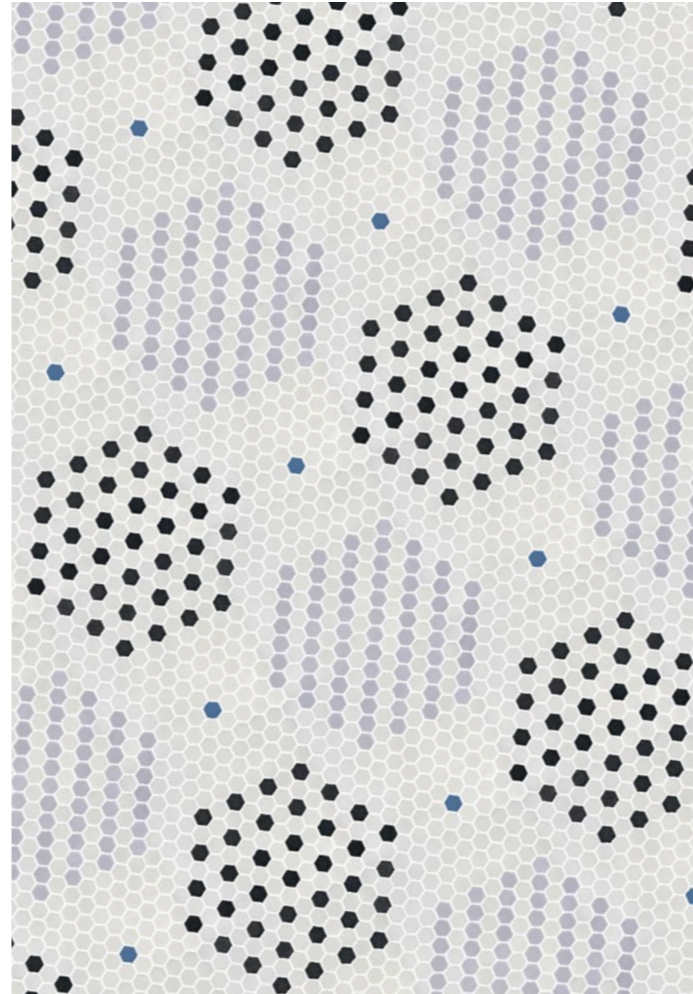

**2004343 Hex Pattern 21** 530  
Hex Stoneglass White, Black, Gainsboro, Light Brun, Green, Ochre.

|       |                           |                            |         |
|-------|---------------------------|----------------------------|---------|
| Sheet | 4,4 mm - 0.173" Thickness | 580x602 mm - 22.83"x23.70" | 0,35 m² |
| Box   | 4 Sheets                  | 0,35 m² - 3.77 sqft        |         |

Repeated module

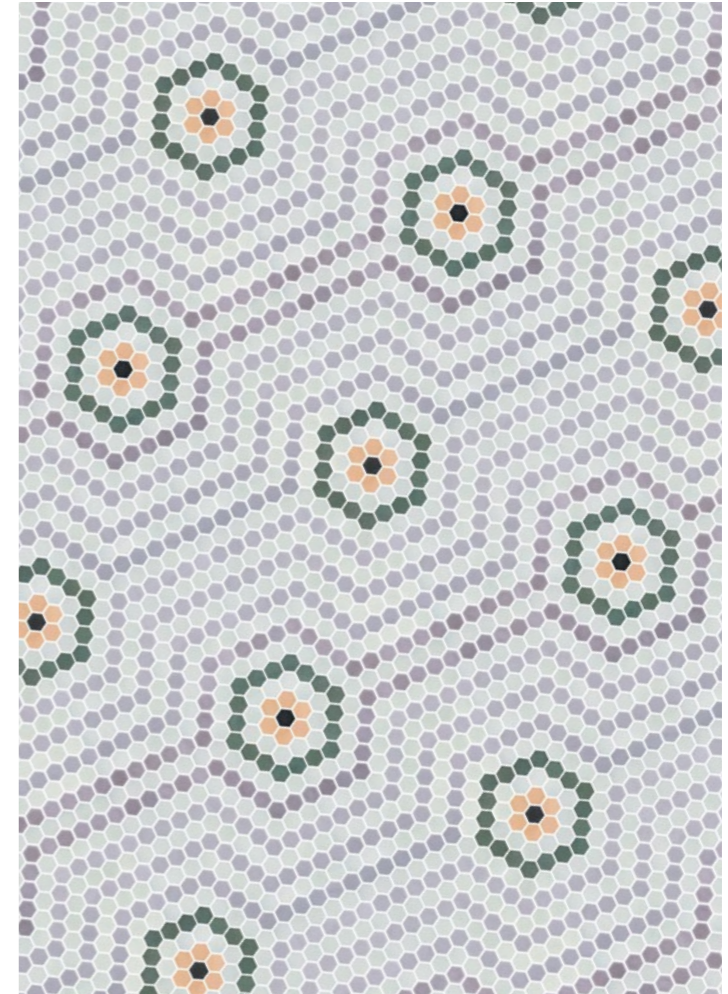



# HEX GEO PATTERNS

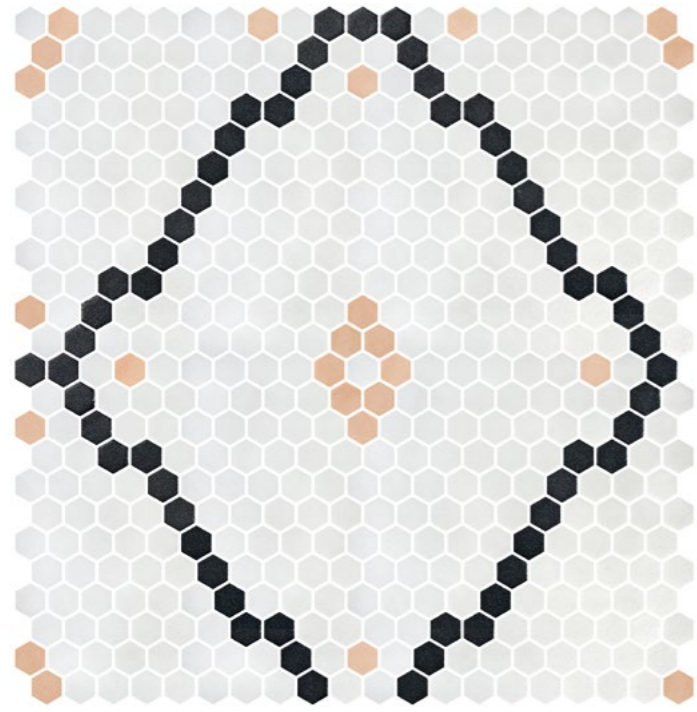

**2004341 Hex Pattern 19** 530  
Hex Stoneglass White, Black, Ochre.

Sheet 4,4 mm - 0.173" Thickness 580x602 mm - 22.83"x23.70" 0,35 m<sup>2</sup>  
Box 4 Sheets 0,35 m<sup>2</sup> - 3.77 sqft

Repeated module

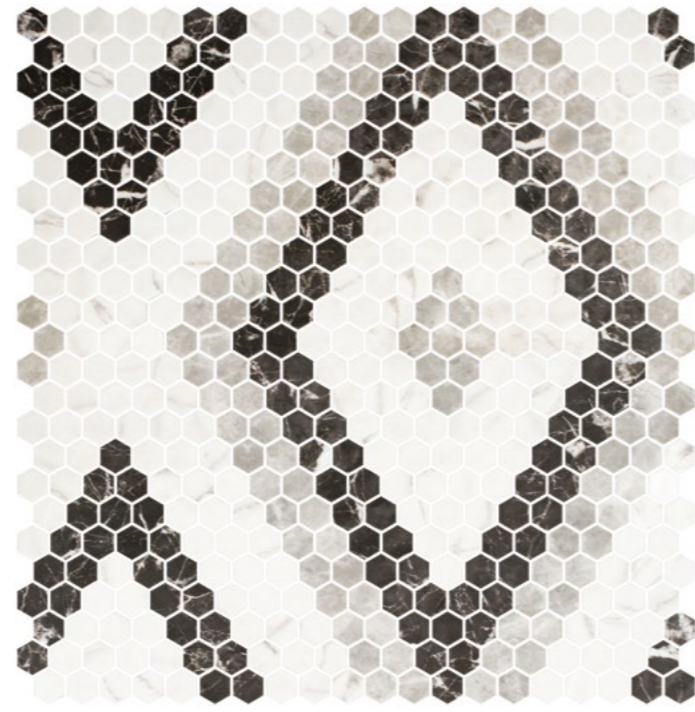

**2003643 Hex Pattern 11** 530  
Hex Nero Marquina Matte, Hex Venato White Matte, Hex Silver Matte.

Sheet 4,4 mm - 0.173" Thickness 580x602 mm - 22.83"x23.70" 0,35 m<sup>2</sup>  
Box 4 Sheets 0,35 m<sup>2</sup> - 3.77 sqft

Repeated module



Hex Pattern 11



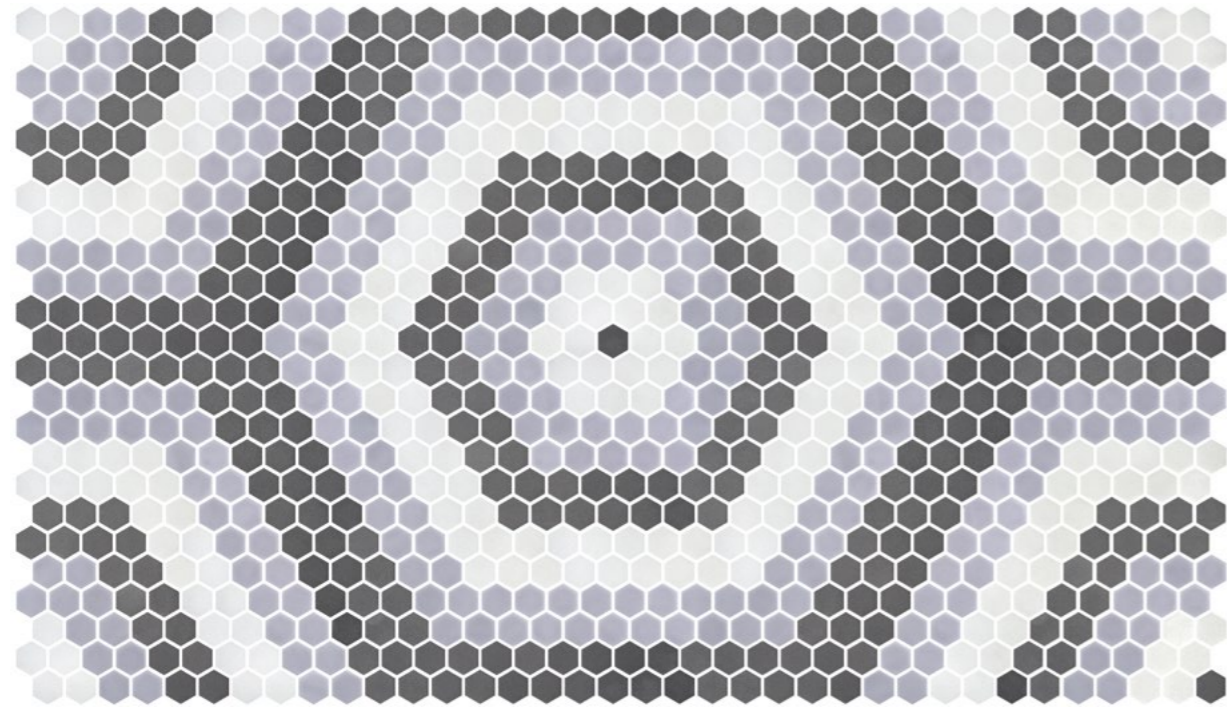

**2004345 Hex Pattern 23** 530  
Hex Stoneglass White, Gainsboro, Grey.

Sheet 4,4 mm - 0.173" Thickness 1044x602 mm - 41.10"x23.70" 0,626 m<sup>2</sup>  
Box 8 Sheets 0,626 m<sup>2</sup> - 6.74 sqft

*Repeated module*

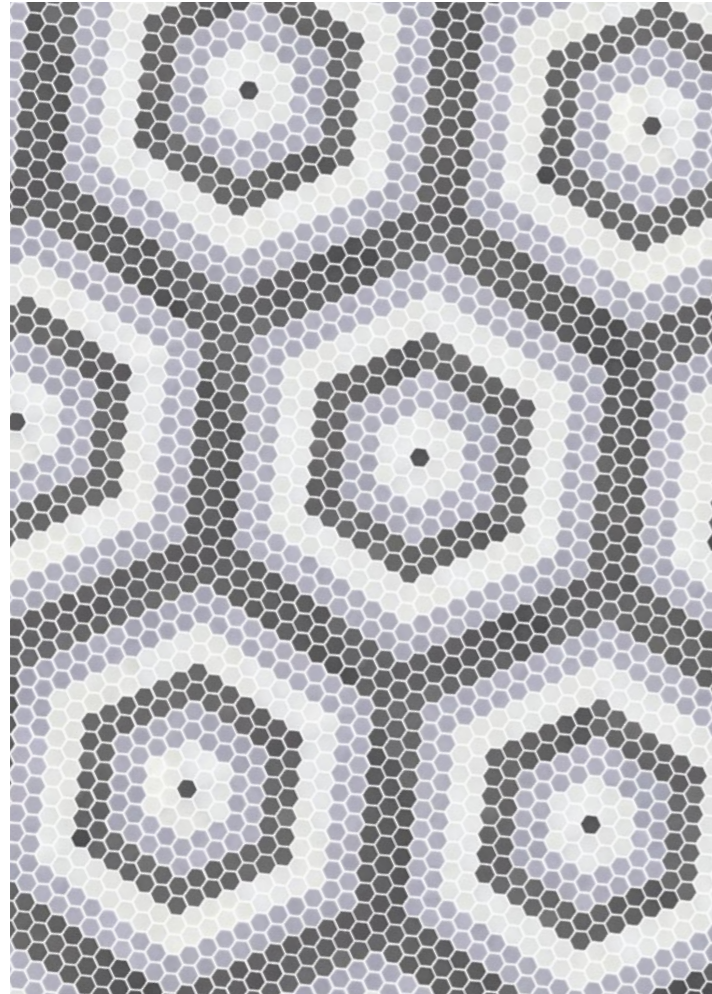

*Hex Pattern 23*

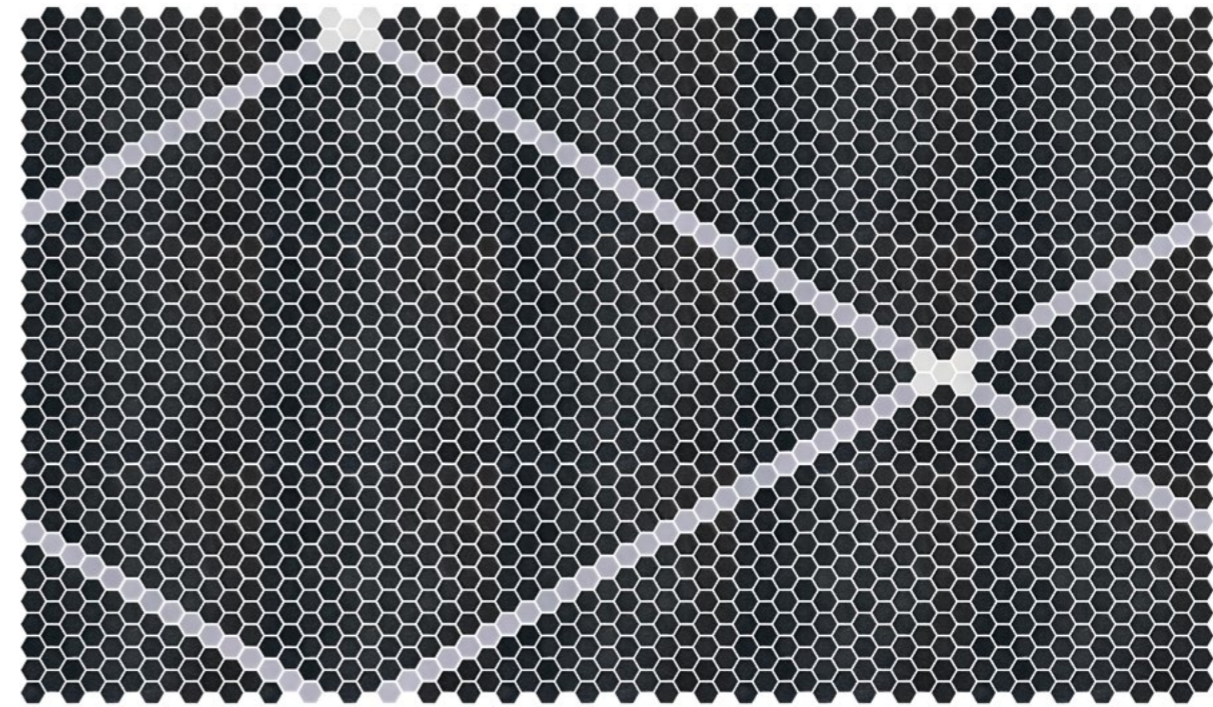

**2004346 Hex Pattern 24** 530  
Hex Stoneglass White, Gainsboro, Black.

Sheet 4,4 mm - 0.173" Thickness 870x1505 mm - 34.25"x 59.25" 1,305 m<sup>2</sup>  
Box 15 Sheets 1,305 m<sup>2</sup> - 14.04 sqft

*Hex Pattern 24*



*Repeated module*











m<sup>2</sup>

MOD

Penta Pattern 1

## PENTA GEO PATTERNS

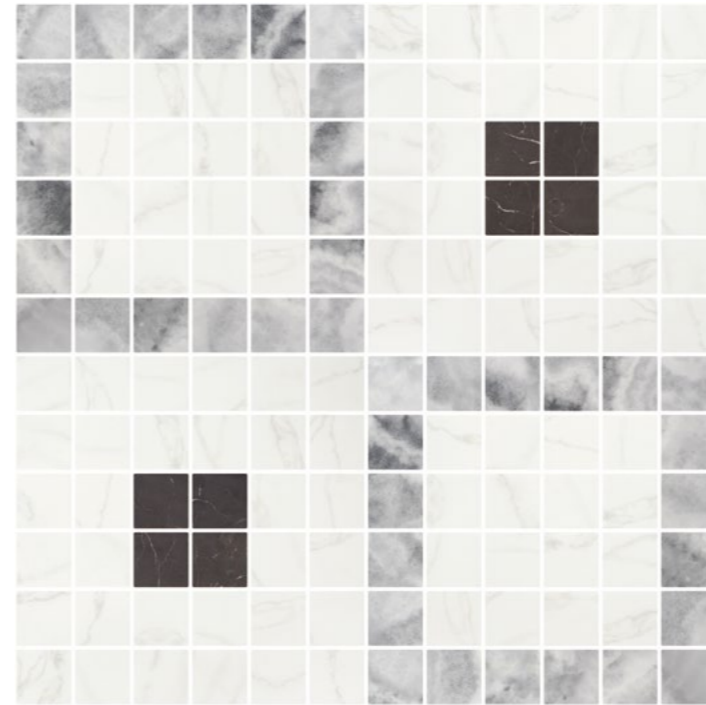

**2003644 Penta Pattern 1** 473  
 Penta Venato White Matte, Penta Onice Matte, Penta Nero Calatorao Matte.  
 Sheet 5,3 mm - 0.20" Thickness 622x622 mm - 24.48"x24.48" 0,39 m<sup>2</sup>  
 Box 4 Sheets 0,39 m<sup>2</sup> - 4.19 sqft

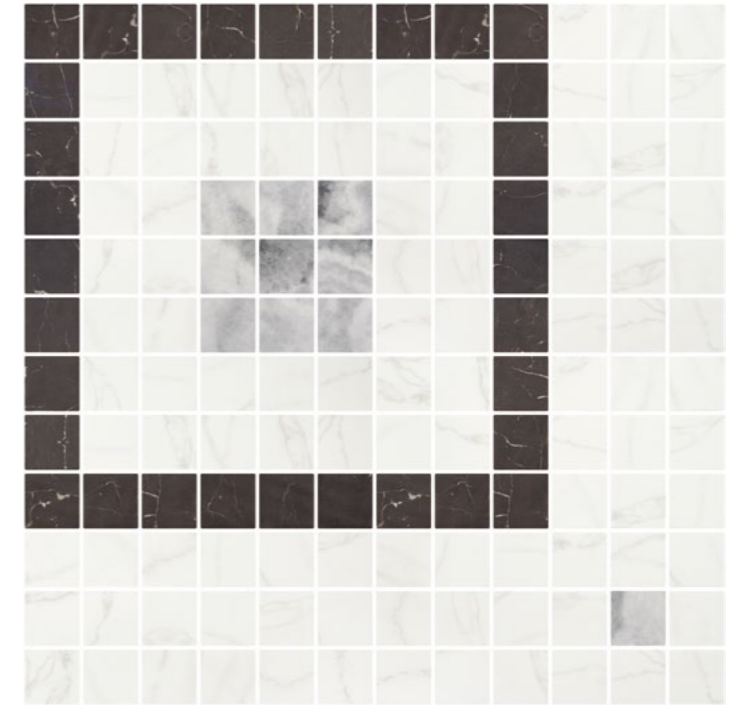

**2003645 Penta Pattern 2** 473  
 Penta Venato White Matte, Penta Onice Matte, Penta Nero Calatorao Matte.  
 Sheet 5,3 mm - 0.20" Thickness 622x622 mm - 24.48"x24.48" 0,39 m<sup>2</sup>  
 Box 4 Sheets 0,39 m<sup>2</sup> - 4.19 sqft

Repeated module

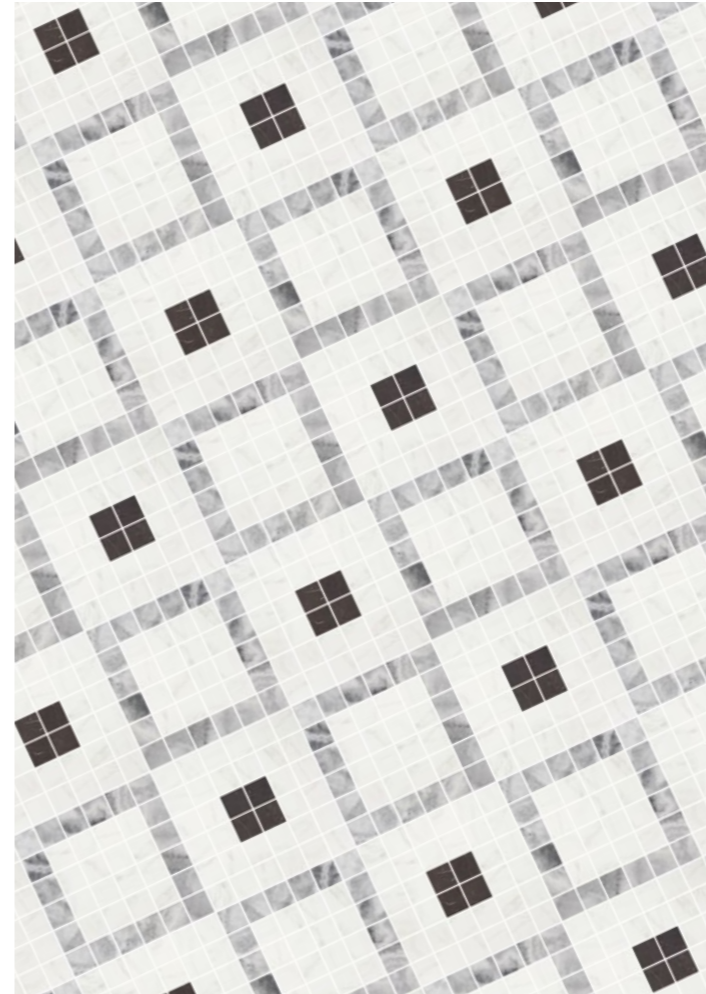

Repeated module

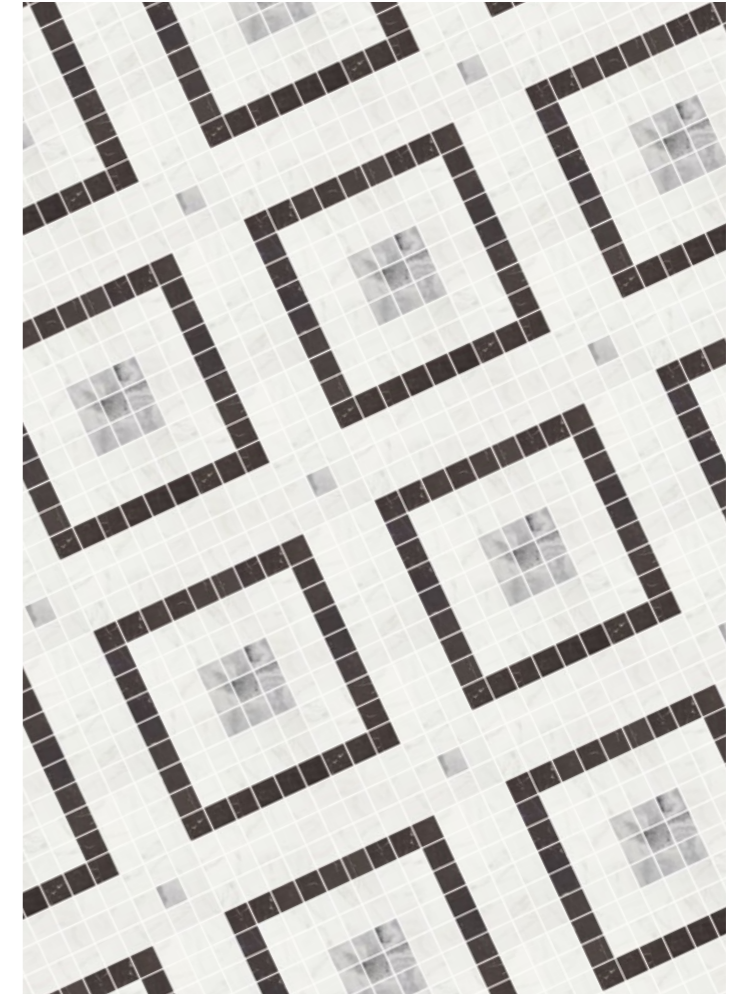



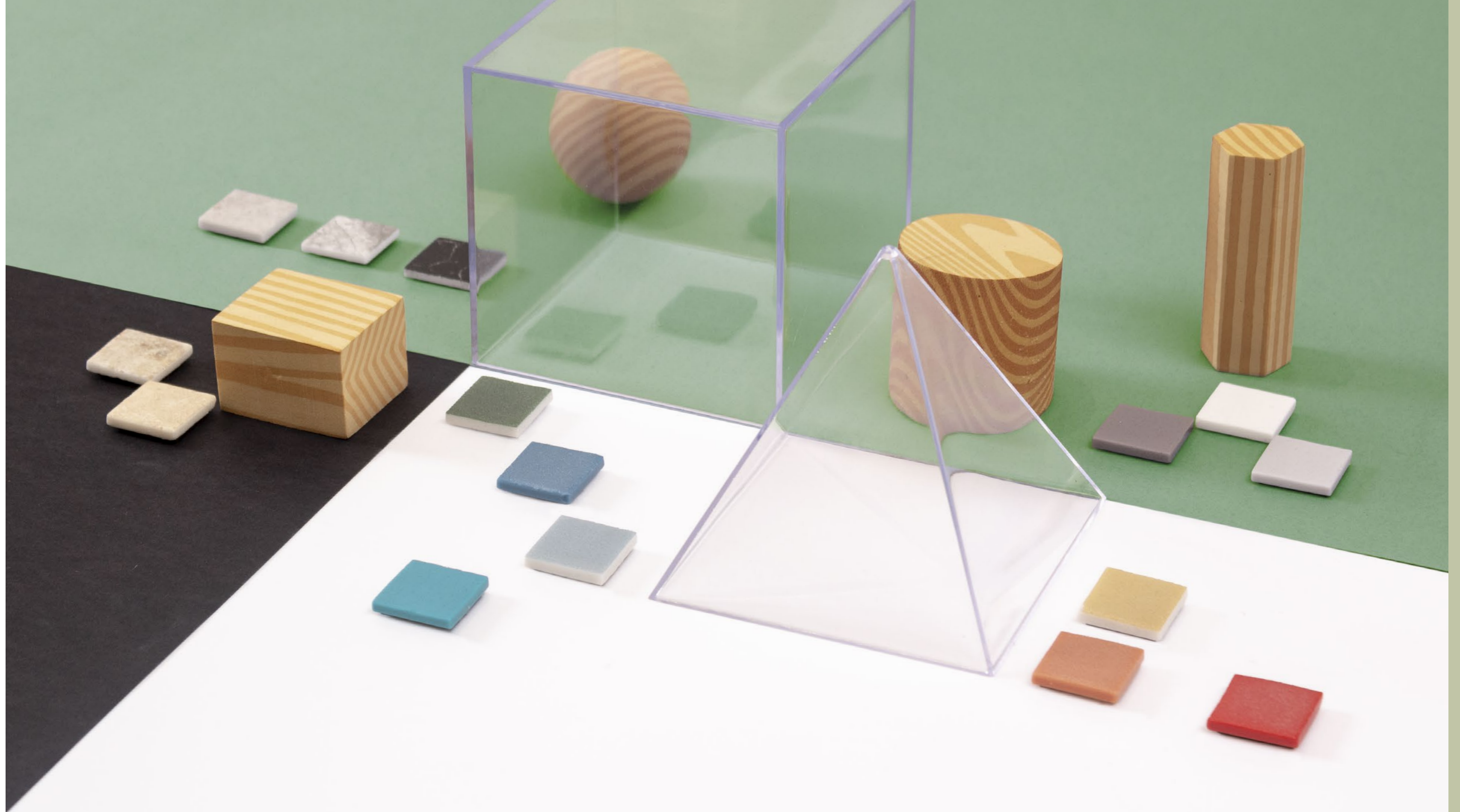

# SQUARE

COLLECTION





## GEO PATTERNS

m<sup>2</sup>

MOD

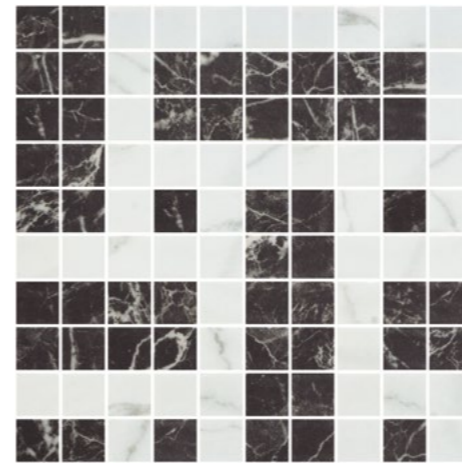

**2003357 Squares Pattern 1** 473  
Nero Marquina Matte, Venato White Matte.

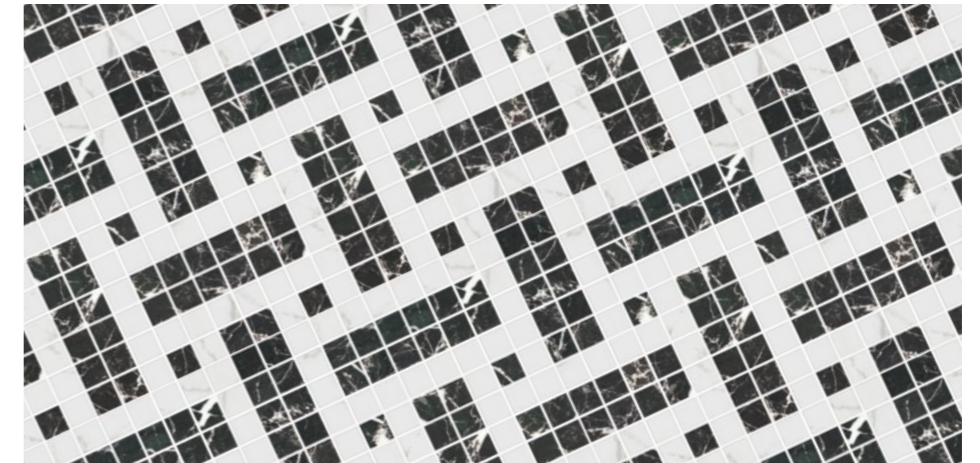

*Repeated module* Sheet 4,9 mm - 0.19" Thickness 259x259 mm - 10.19"x10.19" 0,07 m<sup>2</sup>  
Box 5 Sheets 0,35 m<sup>2</sup> - 3.77 sqft

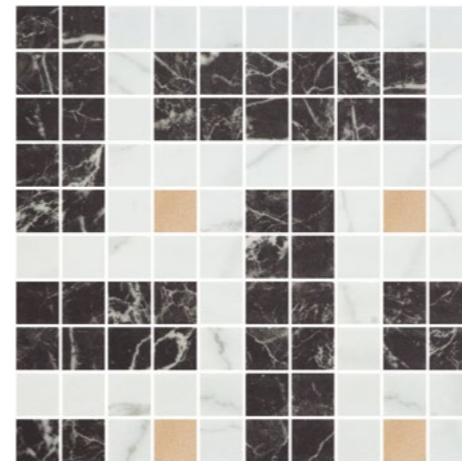

**2004347 Squares Pattern 9** 473  
Nero Marquina Matte, Venato White Matte, Stoneglass Ochre.

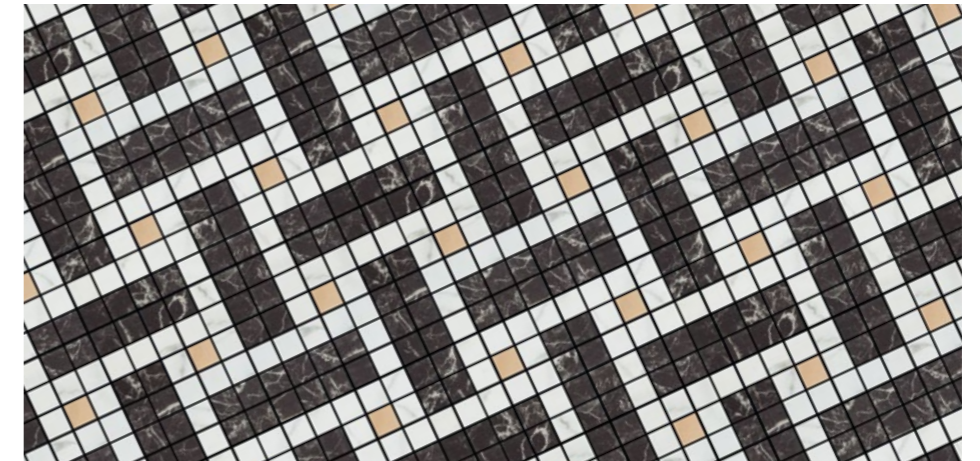

*Repeated module* Sheet 4,9 mm - 0.19" Thickness 259x259 mm - 10.19"x10.19" 0,07 m<sup>2</sup>  
Box 5 Sheets 0,35 m<sup>2</sup> - 3.77 sqft

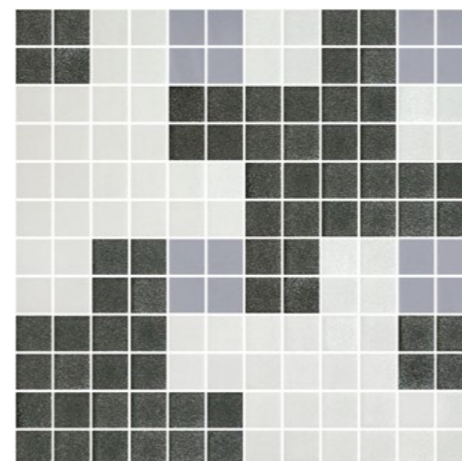

**2004348 Squares Pattern 10** 473  
Stoneglass 25013, 25010, Natureglass Smooth Grey.

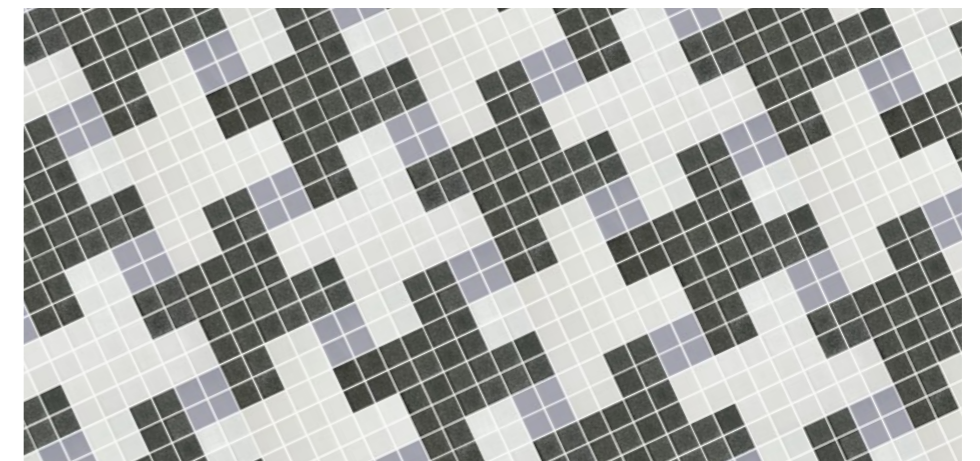

*Repeated module* Sheet 4,9 mm - 0.19" Thickness 311x311 mm - 12.24"x12.24" 0,10 m<sup>2</sup>  
Box 5 Sheets 0,49 m<sup>2</sup> - 5.27 sqft

Squares Pattern 1



# GEO PATTERNS

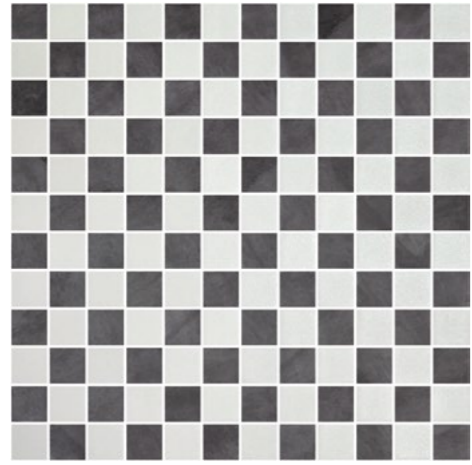

**2003360 Squares Pattern 3** 473  
New Basalt, Stoneglass 25013

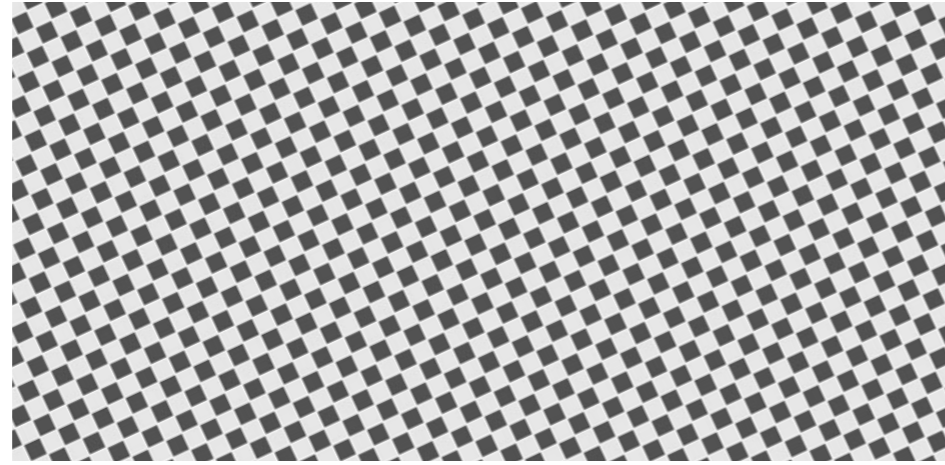

*Repeated module*  
Sheet 4,9 mm - 0.19" Thickness 311x311 mm - 12.24"x12.24" 0,10 m<sup>2</sup>  
Box 5 Sheets 0,49 m<sup>2</sup> - 5.27 sqft

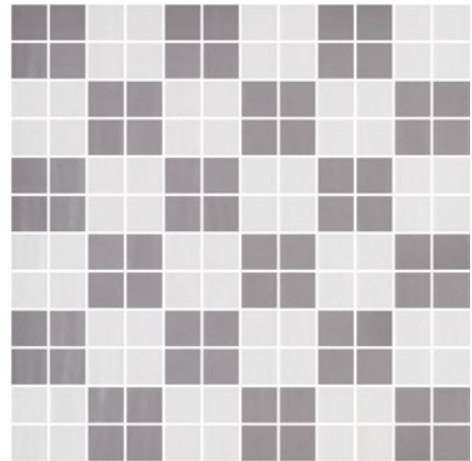

**2003361 Squares Pattern 4** 473  
Natureglass Grey, White.

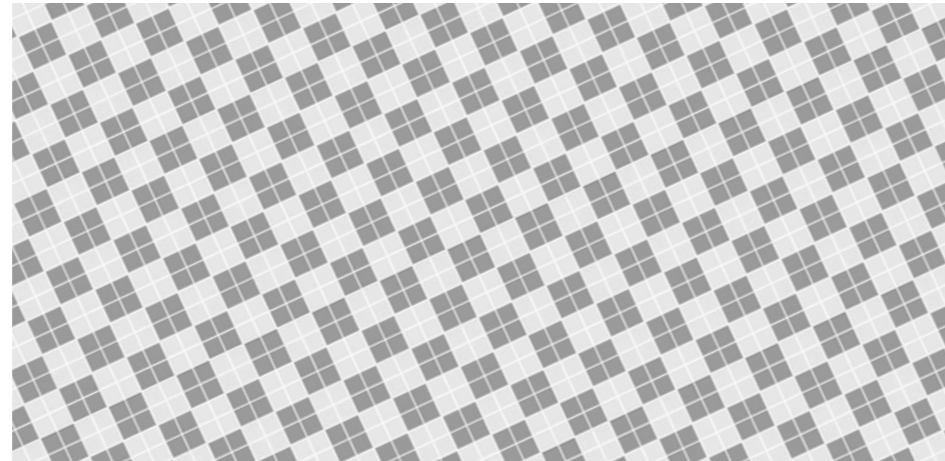

*Repeated module*  
Sheet 4,9 mm - 0.19" Thickness 311x311 mm - 12.24"x12.24" 0,10 m<sup>2</sup>  
Box 5 Sheets 0,49 m<sup>2</sup> - 5.27 sqft

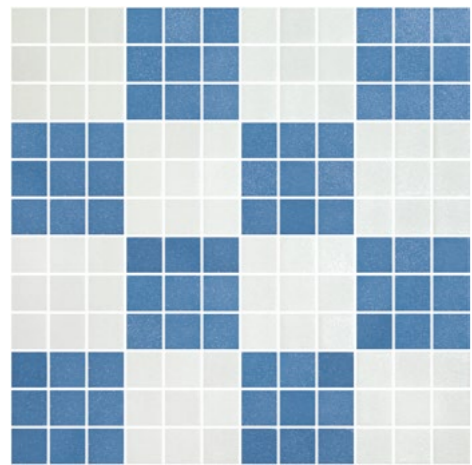

**2003362 Squares Pattern 5** 473  
Stoneglass 25013, Royal Blue.

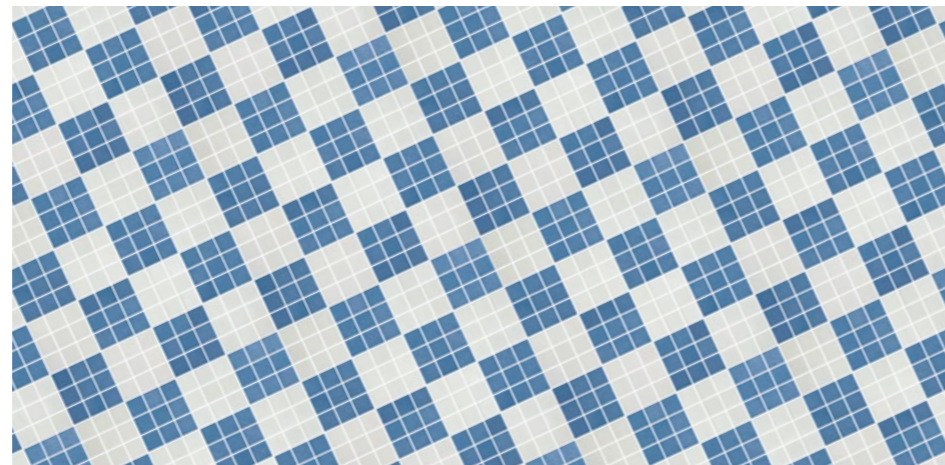

*Repeated module*  
Sheet 4,9 mm - 0.19" Thickness 311x311 mm - 12.24"x12.24" 0,10 m<sup>2</sup>  
Box 5 Sheets 0,49 m<sup>2</sup> - 5.27 sqft



*Squares Pattern 3*



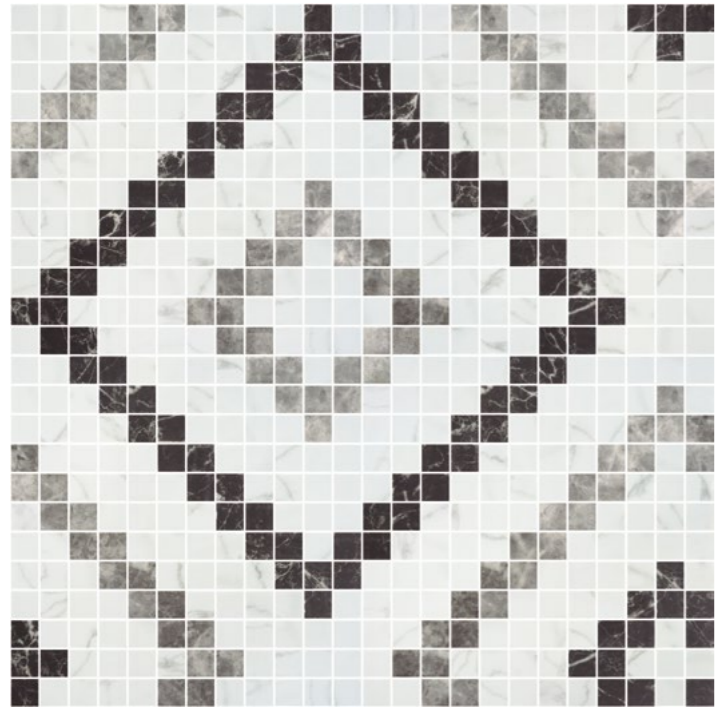

**2003647 Squares Pattern 6** 473  
Venato White Matte, Nero Marquina Matte, Silver Matte.

|       |                          |                            |         |
|-------|--------------------------|----------------------------|---------|
| Sheet | 4,9 mm - 0.19" Thickness | 622x622 mm - 24.48"x24.48" | 0,39 m² |
| Box   | 4 Sheets                 | 0,39 m² - 4.19 sqft        |         |

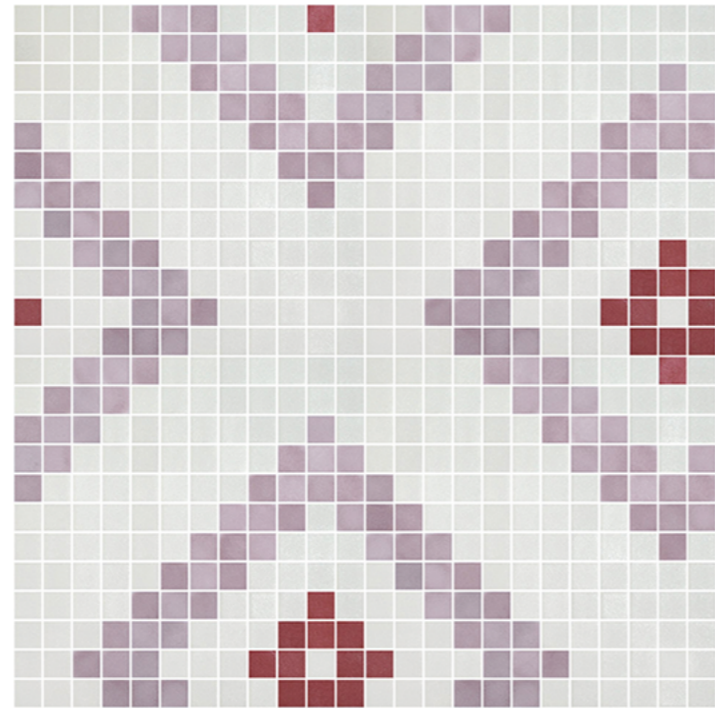

**2004354 Squares Pattern 16** 473  
Stoneglass Russet, Stoneglass 25013, Stoneglass Light Brun.

|       |                          |                            |         |
|-------|--------------------------|----------------------------|---------|
| Sheet | 4,9 mm - 0.19" Thickness | 622x622 mm - 24.48"x24.48" | 0,39 m² |
| Box   | 4 Sheets                 | 0,39 m² - 4.19 sqft        |         |



**2003649 Squares Pattern 8** 473  
Ecru Matte, Ivory Honed, Venato White Matte.

|       |                          |                            |         |
|-------|--------------------------|----------------------------|---------|
| Sheet | 4,9 mm - 0.19" Thickness | 622x622 mm - 24.48"x24.48" | 0,39 m² |
| Box   | 4 Sheets                 | 0,39 m² - 4.19 sqft        |         |

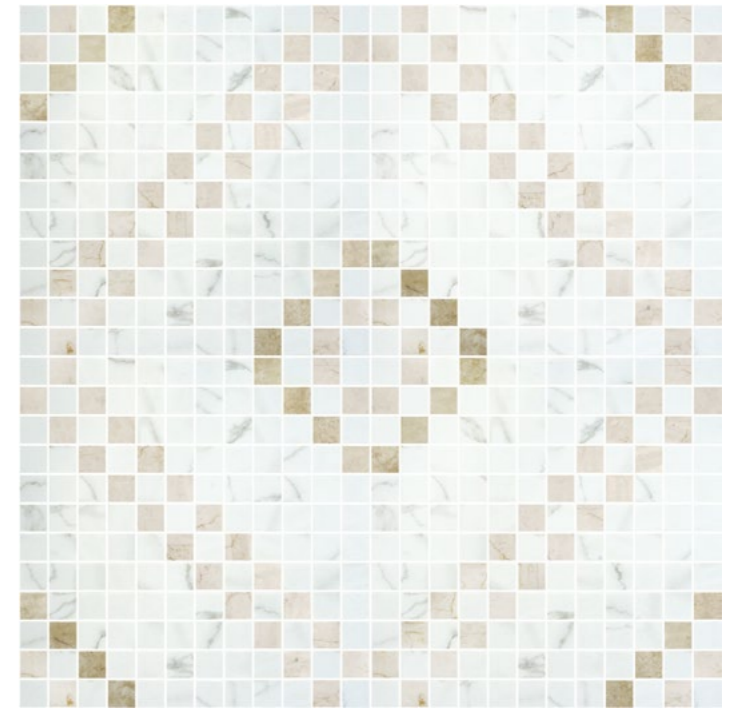

**2004349 Squares Pattern 11** 473  
Ecru Matte, Ivory Honed, Venato White Matte.

|       |                          |                            |         |
|-------|--------------------------|----------------------------|---------|
| Sheet | 4,9 mm - 0.19" Thickness | 622x622 mm - 24.48"x24.48" | 0,39 m² |
| Box   | 4 Sheets                 | 0,39 m² - 4.19 sqft        |         |

Repeated module



Repeated module

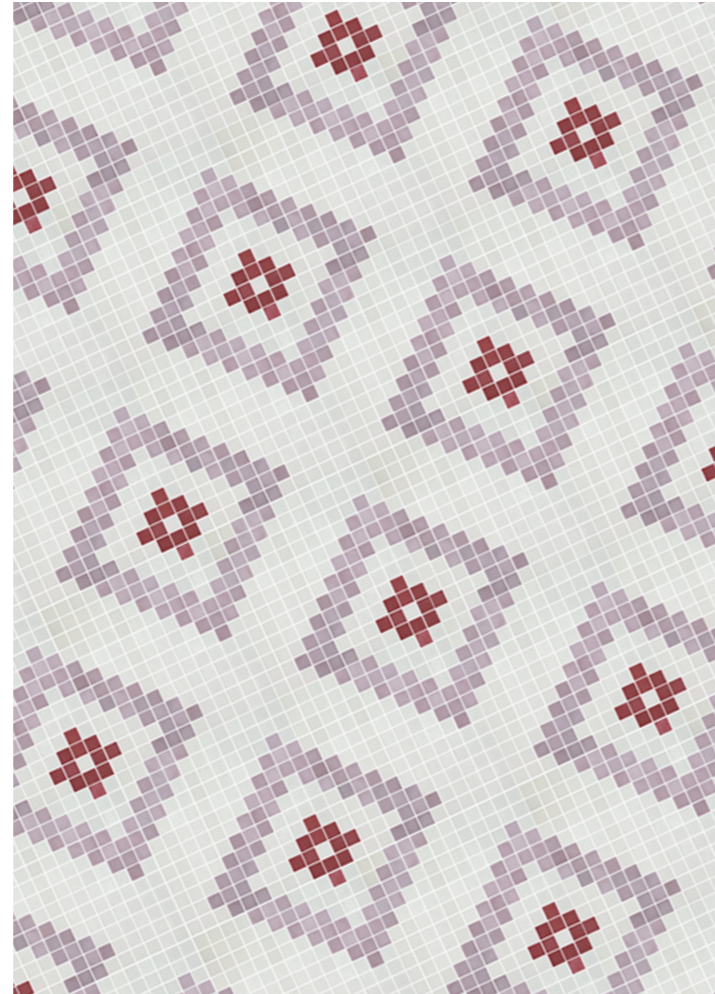

Repeated module



Repeated module





# GEO PATTERNS

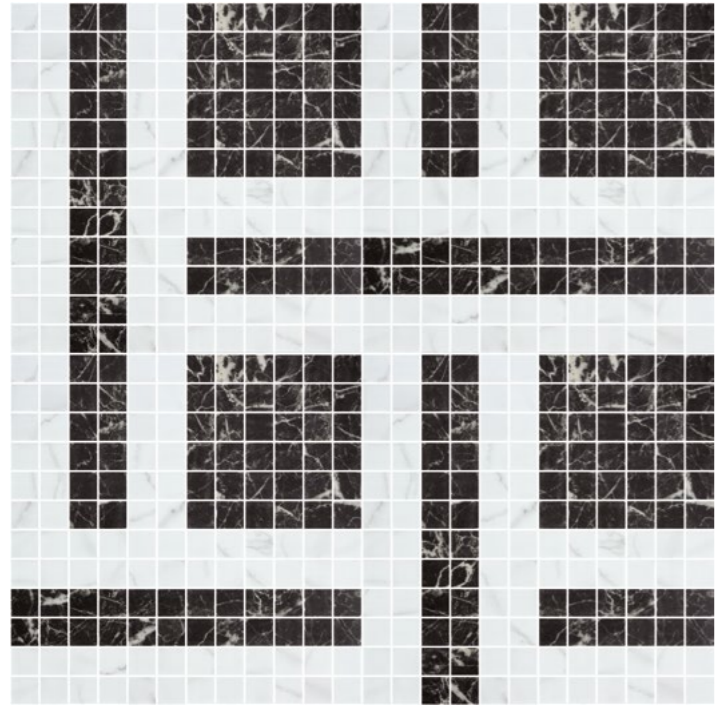

**2004624 Squares Pattern 19** 473  
Venato White Matte, Nero Marquina Matte.

|       |                          |                                 |                     |
|-------|--------------------------|---------------------------------|---------------------|
| Sheet | 4,9 mm - 0.19" Thickness | 622x622 mm - 24.48"x24.48"      | 0,39 m <sup>2</sup> |
| Box   | 4 Sheets                 | 0,39 m <sup>2</sup> - 4.19 sqft |                     |

Repeated module

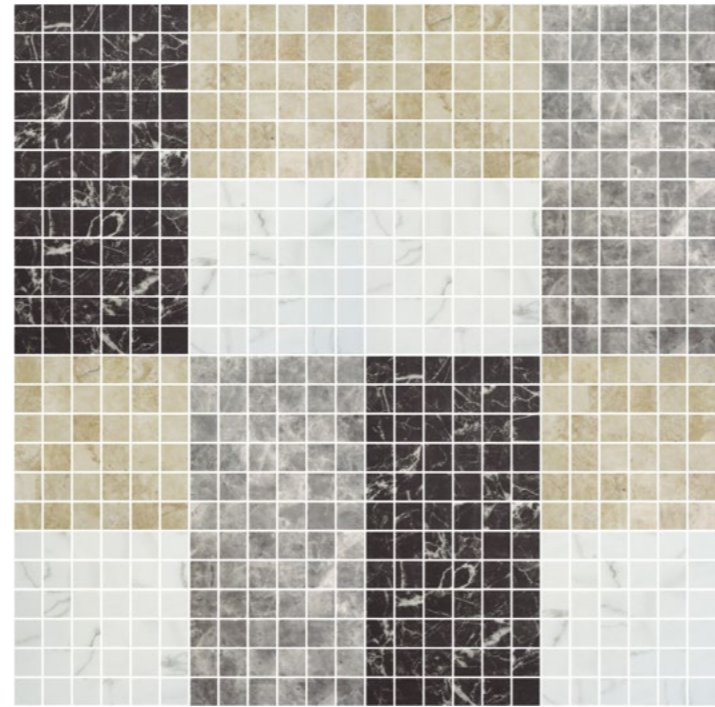
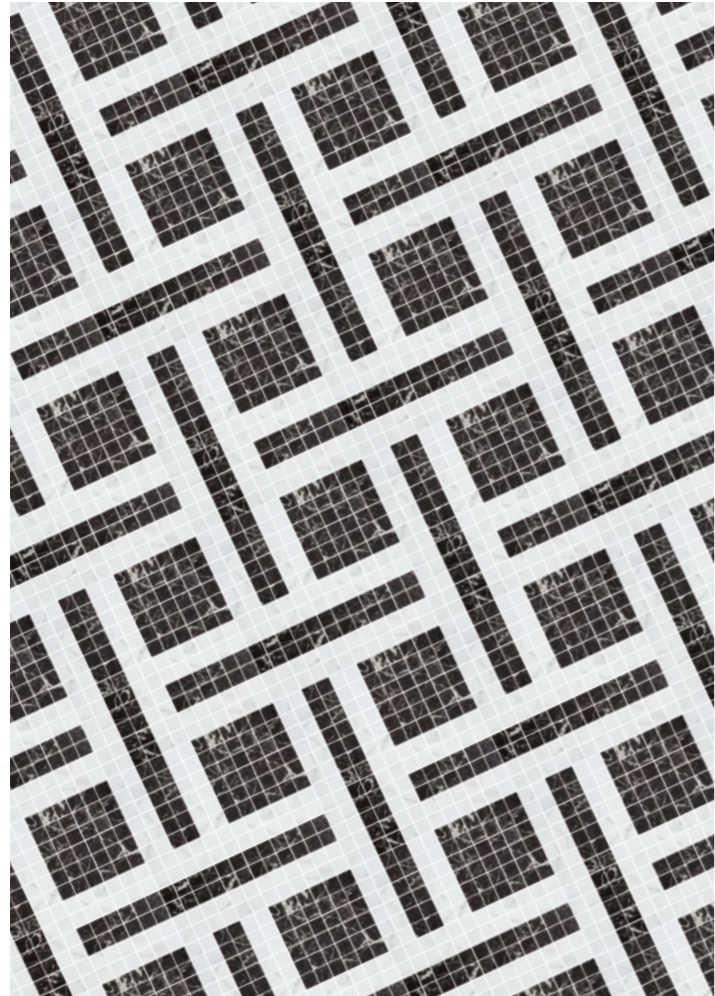

**2004350 Squares Pattern 12** 473  
Venato White Matte, Nero Marquina Matte, Silver Matte, Ecru Matte.

|       |                          |                                 |                     |
|-------|--------------------------|---------------------------------|---------------------|
| Sheet | 4,9 mm - 0.19" Thickness | 622x622 mm - 24.48"x24.48"      | 0,39 m <sup>2</sup> |
| Box   | 4 Sheets                 | 0,39 m <sup>2</sup> - 4.19 sqft |                     |

Repeated module



Squares Pattern 12



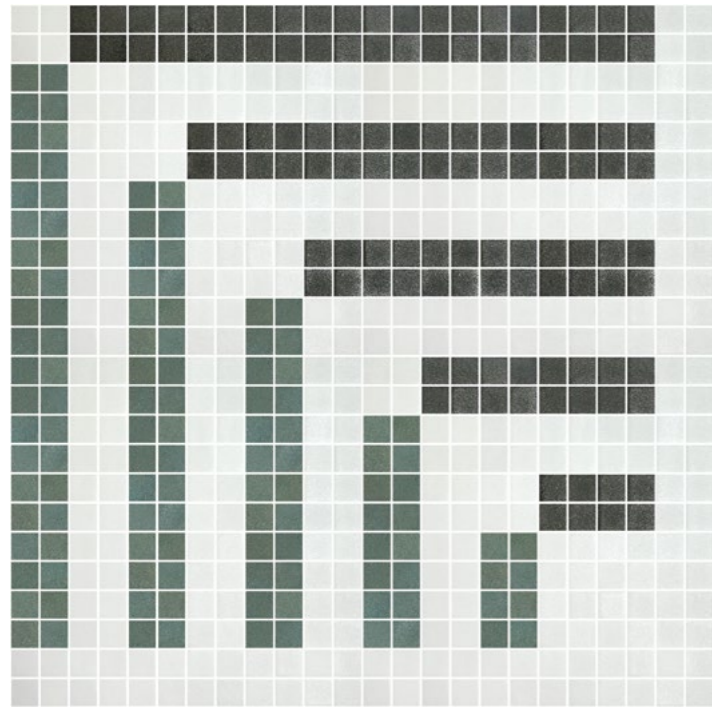

**2004353 Squares Pattern 15** 473  
Stoneglass 25013, 25010, Green.

Sheet 4,9 mm - 0.19" Thickness 622x622 mm - 24.48"x24.48" 0,39 m<sup>2</sup>  
Box 4 Sheets 0,39 m<sup>2</sup> - 4.19 sqft

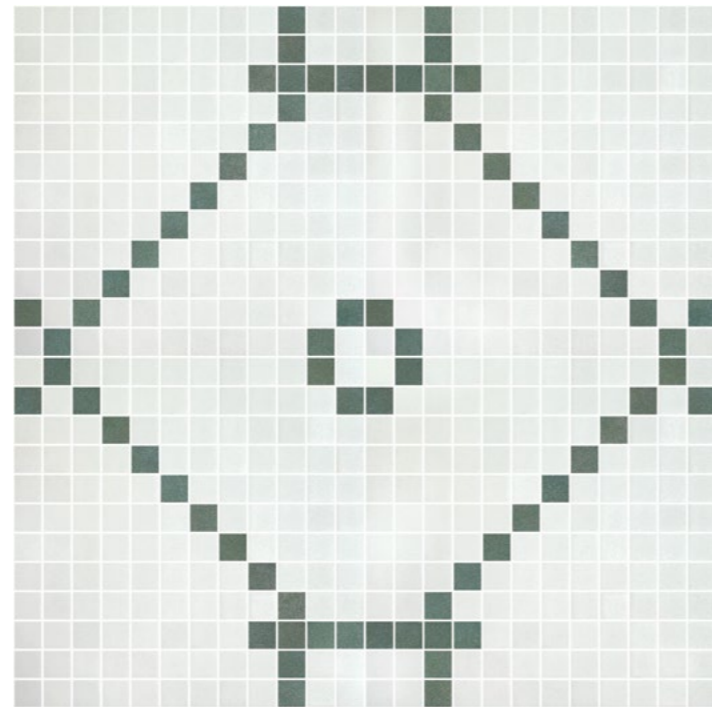

**2003358 Squares Pattern 2** 473  
Stoneglass 25013, Green.

Sheet 4,9 mm - 0.19" Thickness 622x622 mm - 24.48"x24.48" 0,39 m<sup>2</sup>  
Box 4 Sheets 0,39 m<sup>2</sup> - 4.19 sqft

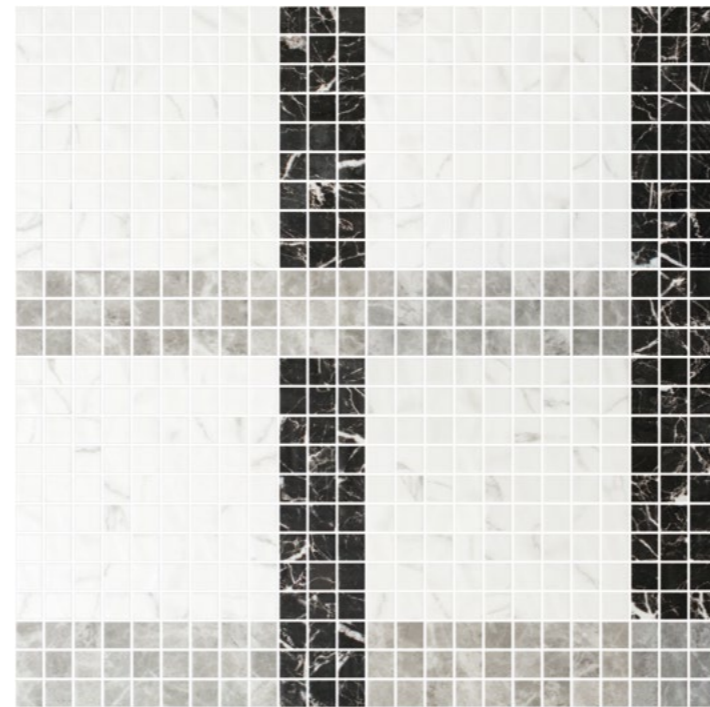

**2003648 Squares Pattern 7** 473  
Venato White Matte, Nero Marquina Matte, Silver Matte.

Sheet 4,9 mm - 0.19" Thickness 622x622 mm - 24.48"x24.48" 0,39 m<sup>2</sup>  
Box 4 Sheets 0,39 m<sup>2</sup> - 4.19 sqft

*Repeated module*

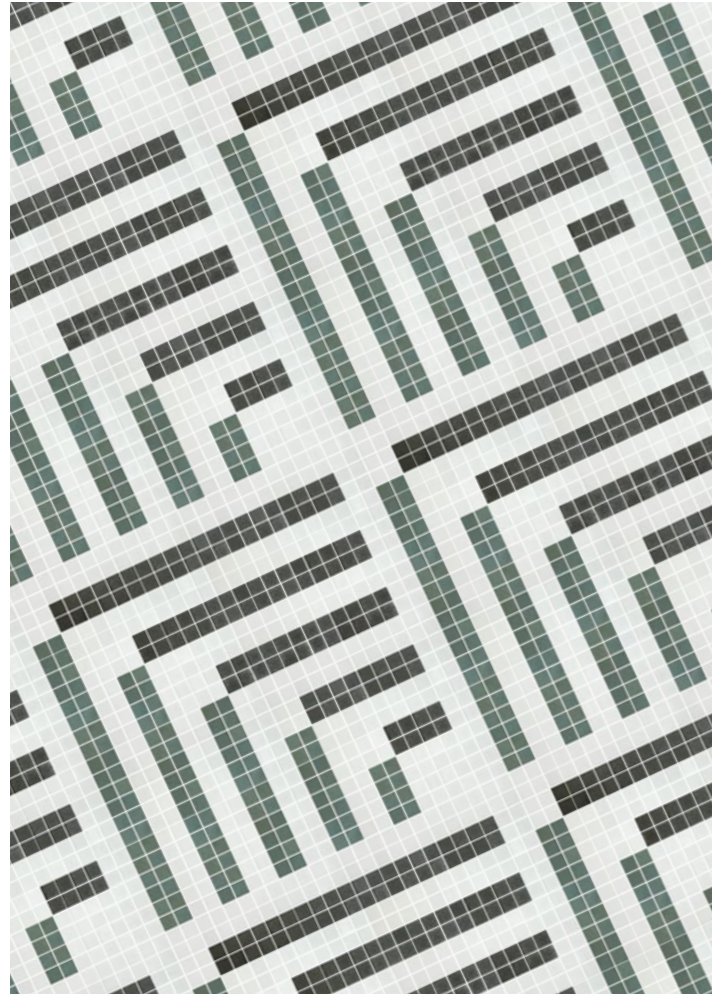

*Repeated module*



*Repeated module*

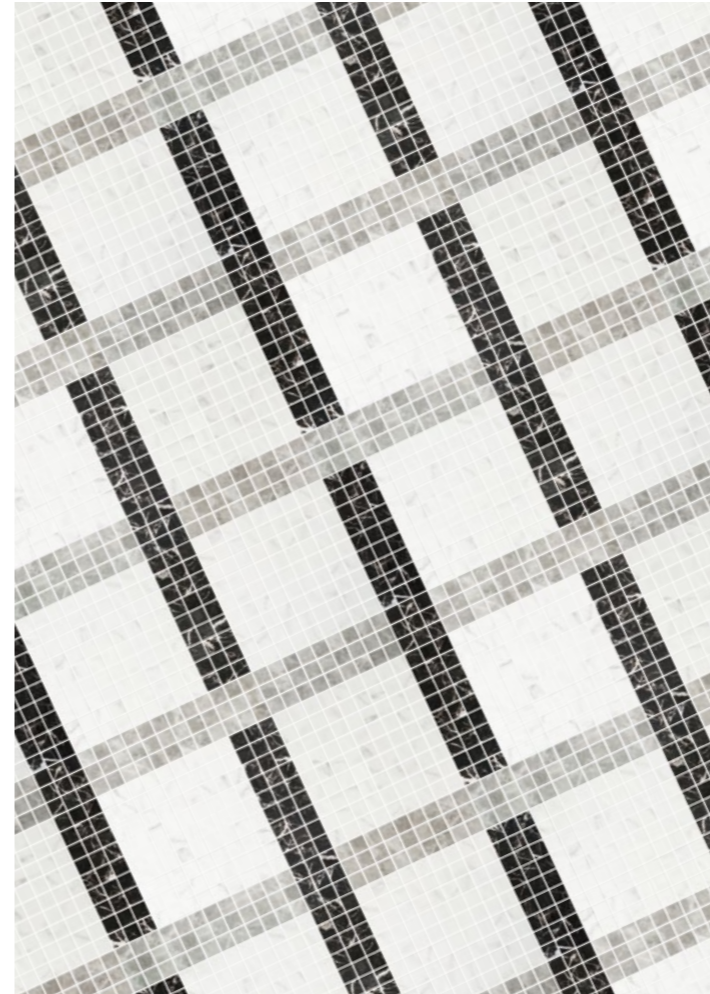



# GEO PATTERNS

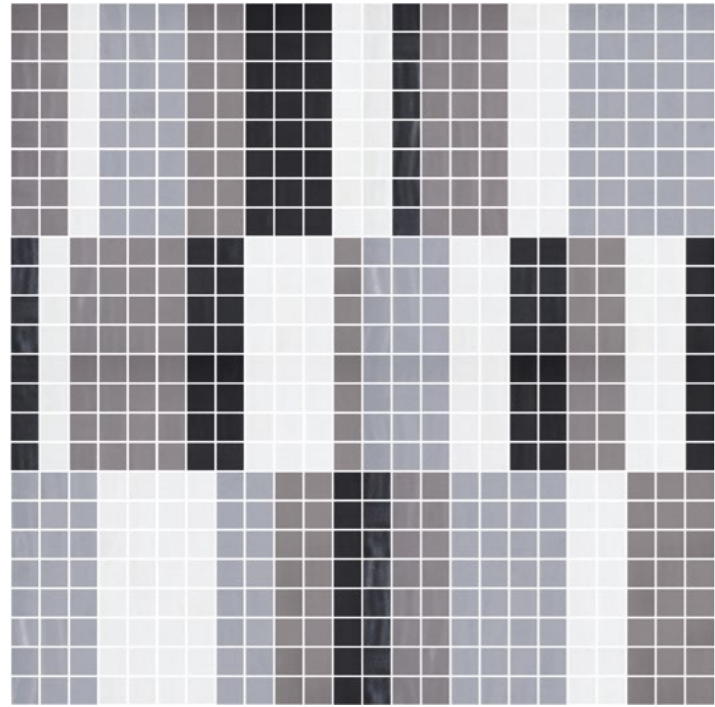

**2004352 Squares Pattern 14** 473  
Natureglass White, Black, Dark Grey, Smooth Grey.

|       |                          |                                 |                     |
|-------|--------------------------|---------------------------------|---------------------|
| Sheet | 4,9 mm - 0.19" Thickness | 622x622 mm - 24.48"x24.48"      | 0,39 m <sup>2</sup> |
| Box   | 4 Sheets                 | 0,39 m <sup>2</sup> - 4.19 sqft |                     |

Repeated module

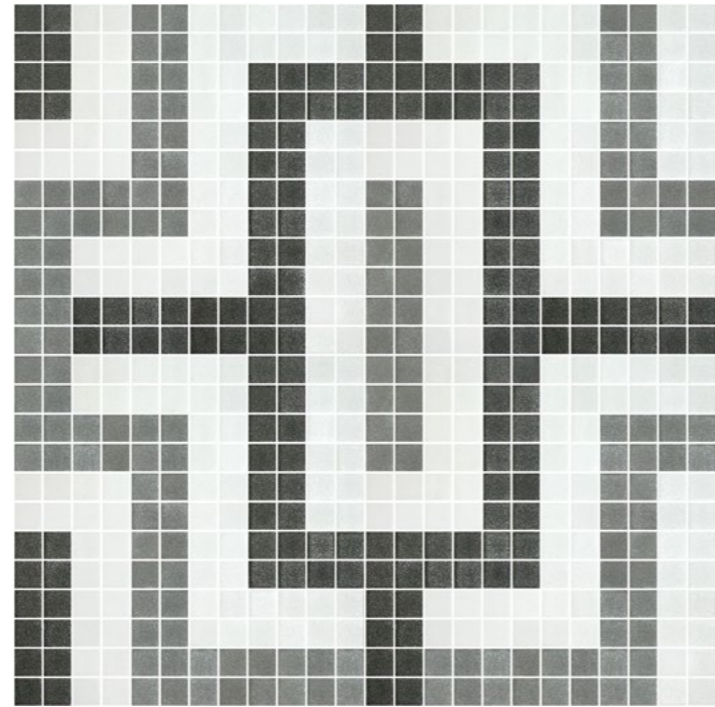
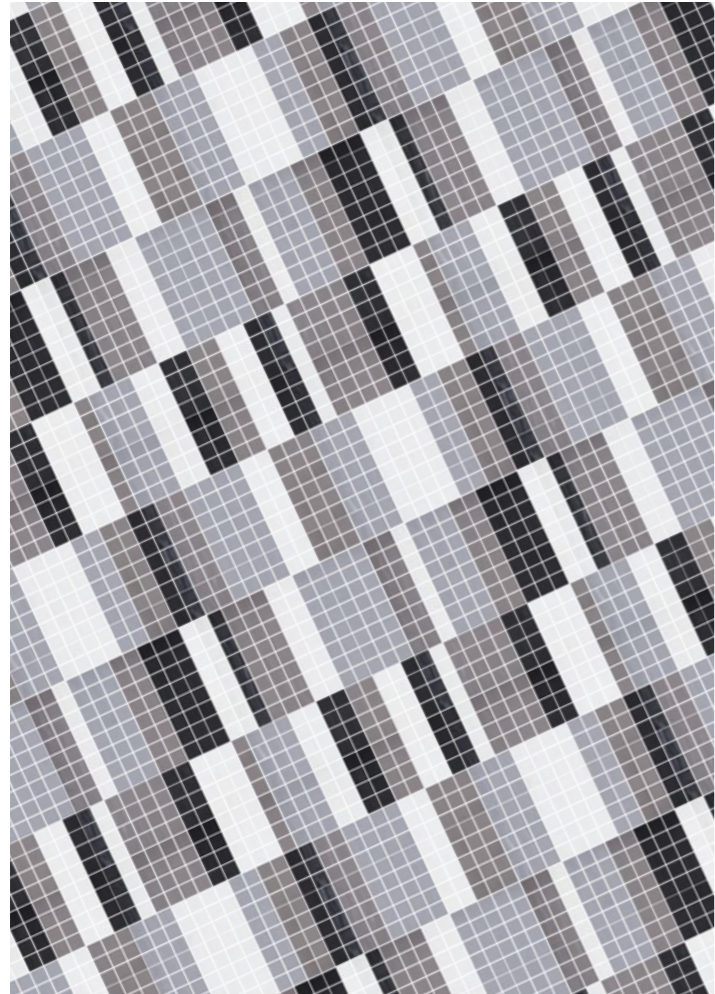

**2004351 Squares Pattern 13** 473  
Stoneglass 25013, 25010, 25011.

|       |                          |                                 |                     |
|-------|--------------------------|---------------------------------|---------------------|
| Sheet | 4,9 mm - 0.19" Thickness | 622x622 mm - 24.48"x24.48"      | 0,39 m <sup>2</sup> |
| Box   | 4 Sheets                 | 0,39 m <sup>2</sup> - 4.19 sqft |                     |

Repeated module

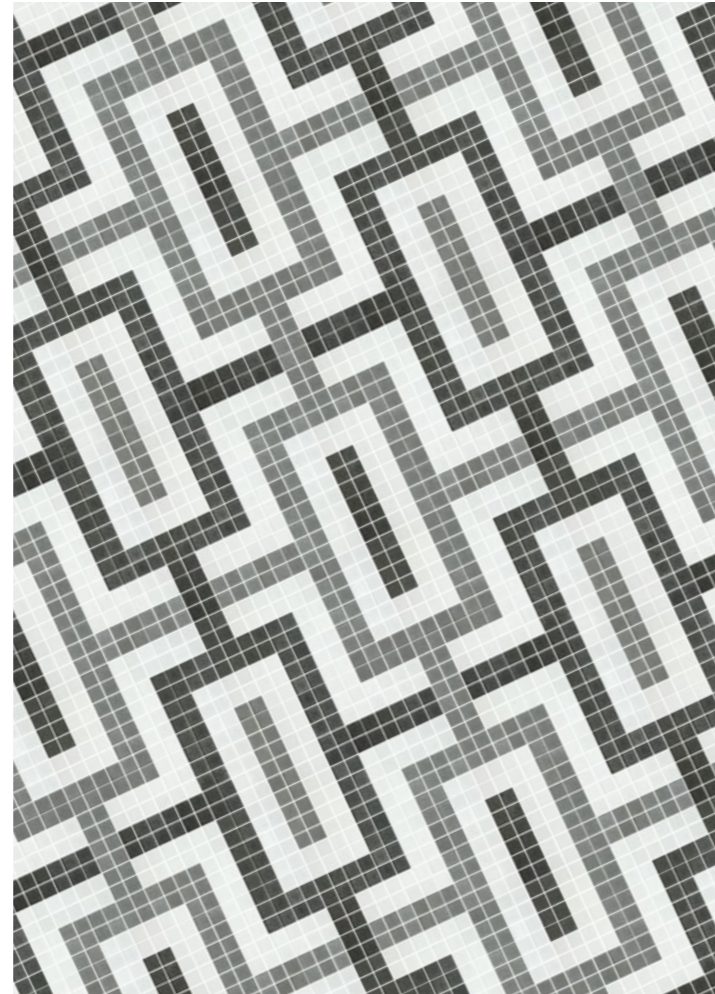

Squares Pattern 14



# GEO PATTERNS

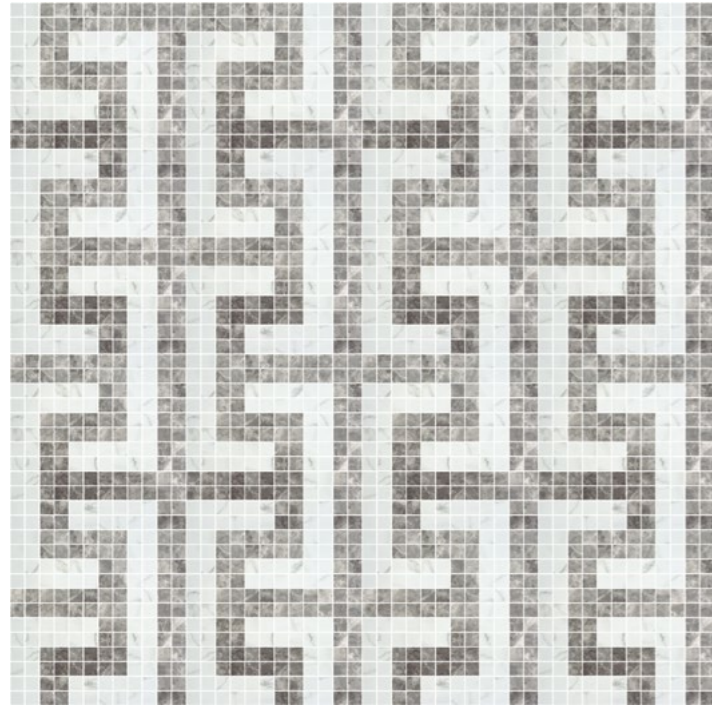

**2004355 Squares Pattern 17** 473  
Venato White Matte, Silver Matte.

Sheet 4,9 mm - 0.19" Thickness 1244x1244 mm - 48.98"x 48.98" 1,54 m<sup>2</sup>  
Box 16 Sheets 1,54 m<sup>2</sup> - 16.57 sqft

Repeated module

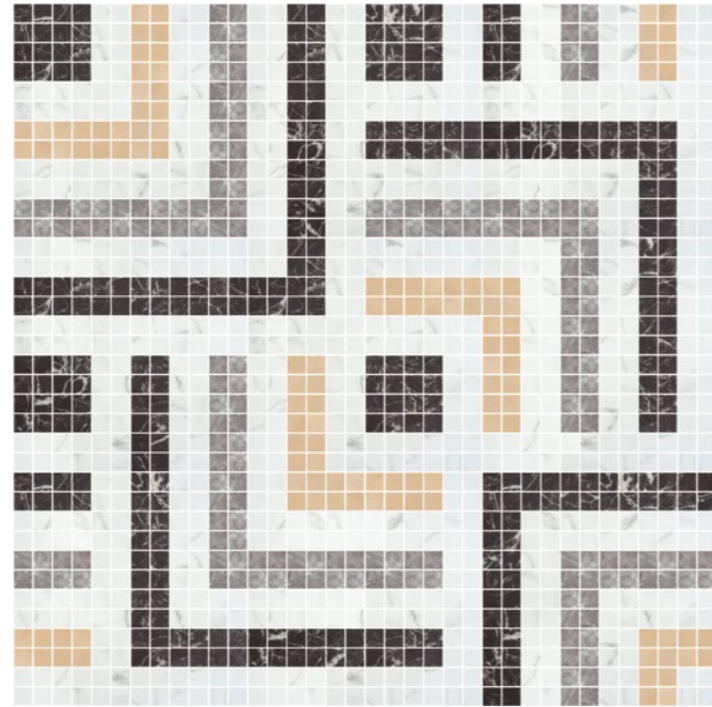

**2004356 Squares Pattern 18** 473  
Venato White Matte, Nero Marquina Matte, Silver Matte, Stoneglass Ochre.

Sheet 4,9 mm - 0.19" Thickness 933x933 mm - 36.73"x 36.73" 0,87 m<sup>2</sup>  
Box 9 Sheets 0,87 m<sup>2</sup> - 9.36 sqft

Repeated module



Squares Pattern 18





## DECO PATTERNS

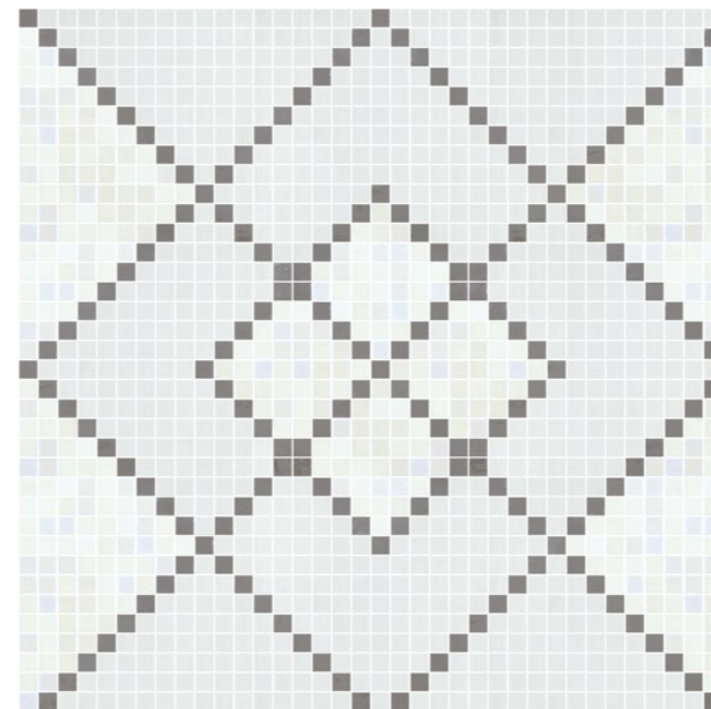

**2003351 Web White Grey** 595  
Opalo Blanco, Natureglass White, Opalo Gris.

|       |                          |                                 |                     |
|-------|--------------------------|---------------------------------|---------------------|
| Sheet | 4,9 mm - 0.19" Thickness | 933x933 mm - 36.73"x 36.73"     | 0,87 m <sup>2</sup> |
| Box   | 9 Sheets                 | 0,87 m <sup>2</sup> - 9.36 sqft |                     |

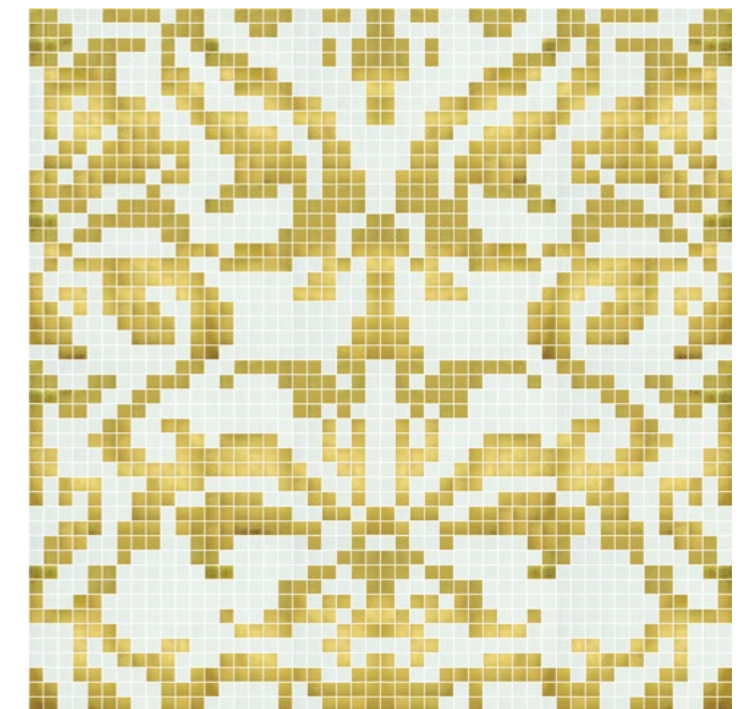

**2003356 Oriental Dreams Gold** 918  
Natureglass White, Nador.

|       |                          |                                  |                     |
|-------|--------------------------|----------------------------------|---------------------|
| Sheet | 4,9 mm - 0.19" Thickness | 1244x1244 mm - 48.98"x 48.98"    | 1,54 m <sup>2</sup> |
| Box   | 16 Sheets                | 1,54 m <sup>2</sup> - 16.57 sqft |                     |

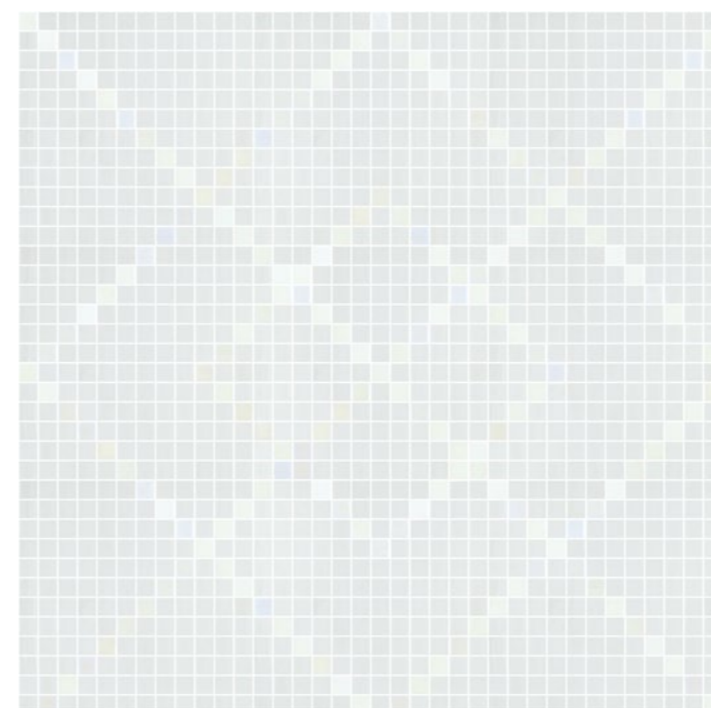

**2003352 Web White** 595  
Opalo Blanco, Natureglass White.

|       |                          |                                 |                     |
|-------|--------------------------|---------------------------------|---------------------|
| Sheet | 4,9 mm - 0.19" Thickness | 933x933 mm - 36.73"x 36.73"     | 0,87 m <sup>2</sup> |
| Box   | 9 Sheets                 | 0,87 m <sup>2</sup> - 9.36 sqft |                     |

Web White Grey



# DECO PATTERNS

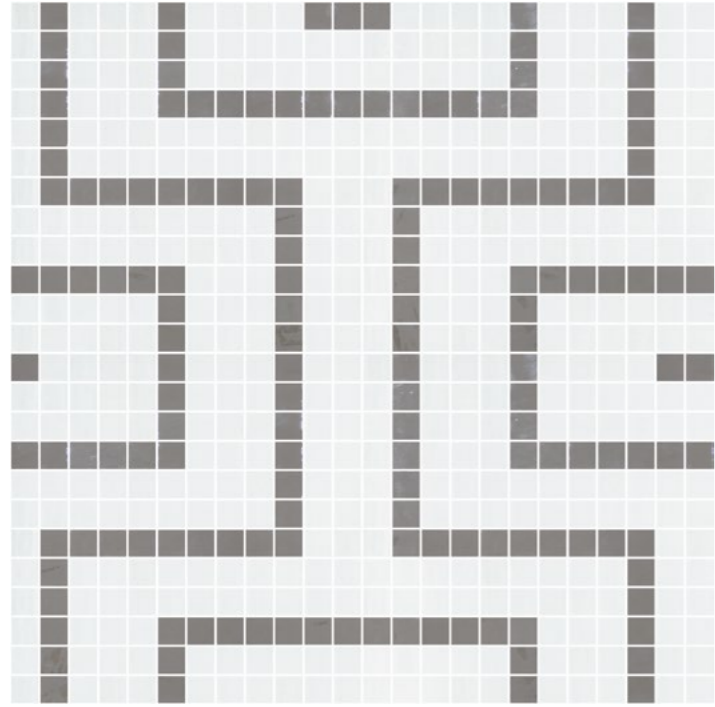

**2003350 Labyrinth Grey** 595  
Opalo Gris, Natureglass White.

Sheet 4,9 mm - 0.19" Thickness 622x622 mm - 24.48"x24.48" 0,39 m<sup>2</sup>  
Box 4 Sheets 0,39 m<sup>2</sup> - 4.19 sqft

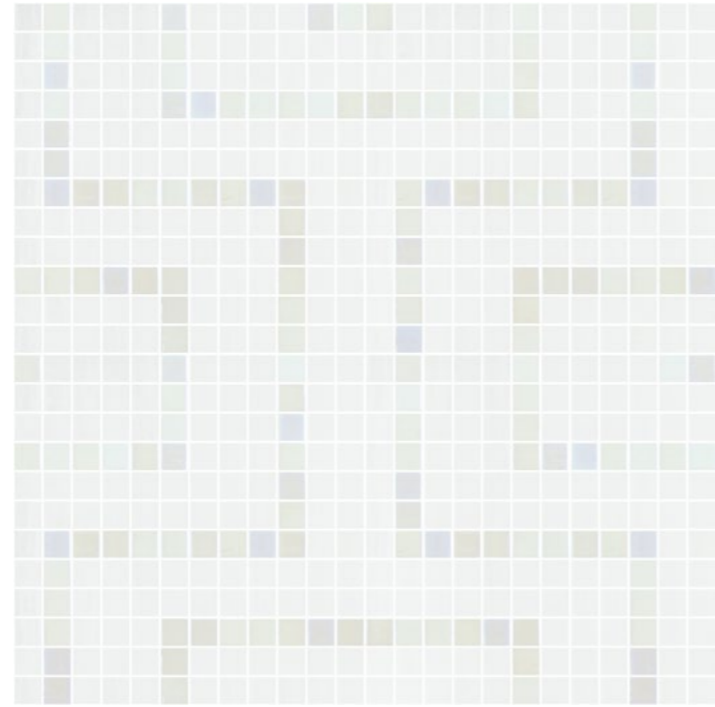

**2003349 Labyrinth White** 595  
Opalo Blanco, Natureglass White.

Sheet 4,9 mm - 0.19" Thickness 622x622 mm - 24.48"x24.48" 0,39 m<sup>2</sup>  
Box 4 Sheets 0,39 m<sup>2</sup> - 4.19 sqft

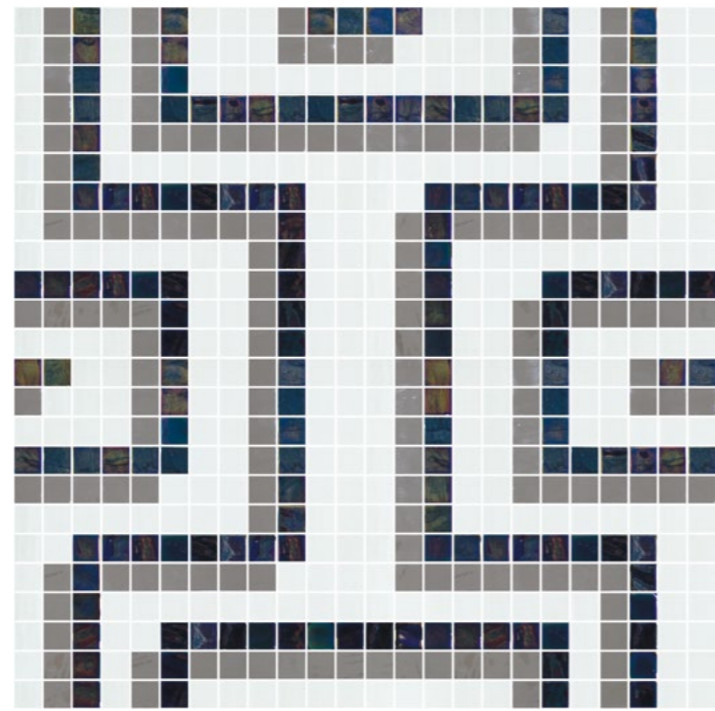

**2002098 Inca Grey** 595  
Stoneglass 25013, Opalo Gris, Opalo Negro.

Sheet 4,9 mm - 0.19" Thickness 622x622 mm - 24.48"x24.48" 0,39 m<sup>2</sup>  
Box 4 Sheets 0,39 m<sup>2</sup> - 4.19 sqft



*Inca Grey*





# SHADING BLENDS

Sheet 4,9 mm - 0.19" Thickness 311x2488 mm - 12.24"x97.95" 0,77 m<sup>2</sup>  
 Box 8 Sheets 0,77 m<sup>2</sup> - 8.28 sqft

2002346 Brown Illusion 510

2002343 Markina White 472

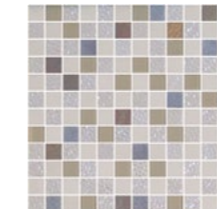
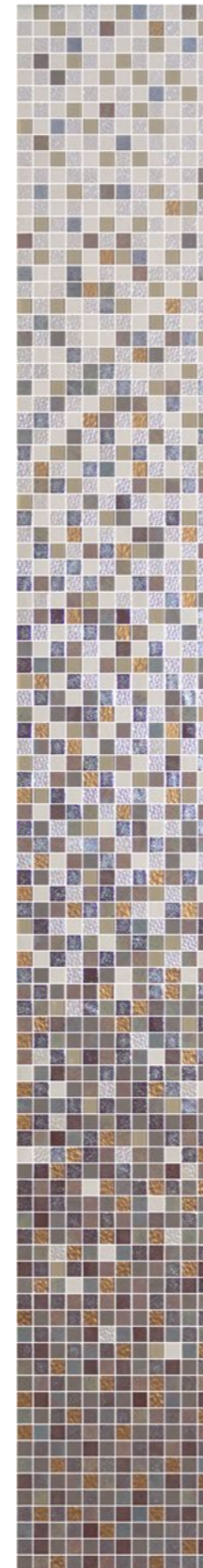

2002365 Sinai 510



2002359 Indico 472

2002364 Savina 510

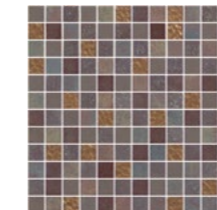

2002358 Atlántico 472

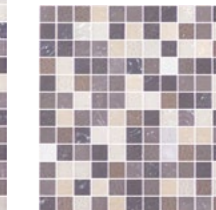

Brown Illusion



# SHADING BLENDS

Sheet 4,9 mm - 0.19" Thickness 311x2488 mm - 12.24"x97.95" 0,77 m<sup>2</sup>  
 Box 8 Sheets 0,77 m<sup>2</sup> - 8.28 sqft



2002342 Markina Black 472

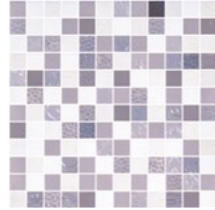

2002354 Indor 472

2002530 Manatí 472

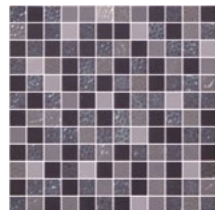

2002345 Sea Grey 430

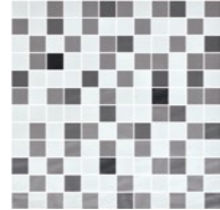
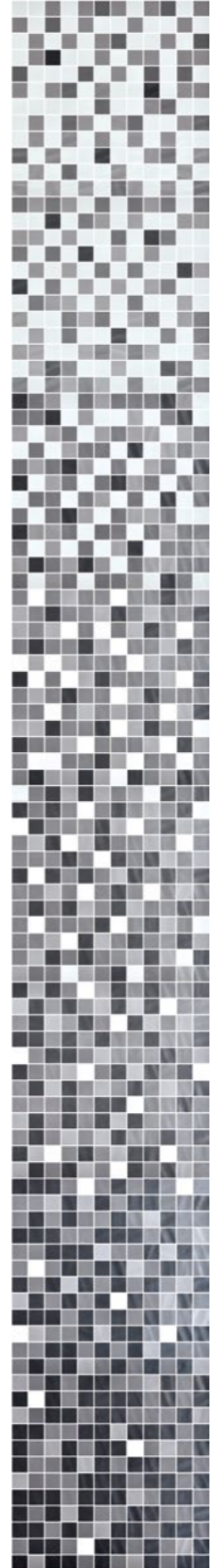

2002363 Grey Blend 1 390

2002362 Grey Blend 8 390

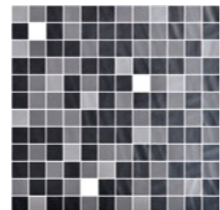

Sea Grey



DECO 2020



AQUASTYLE 2020

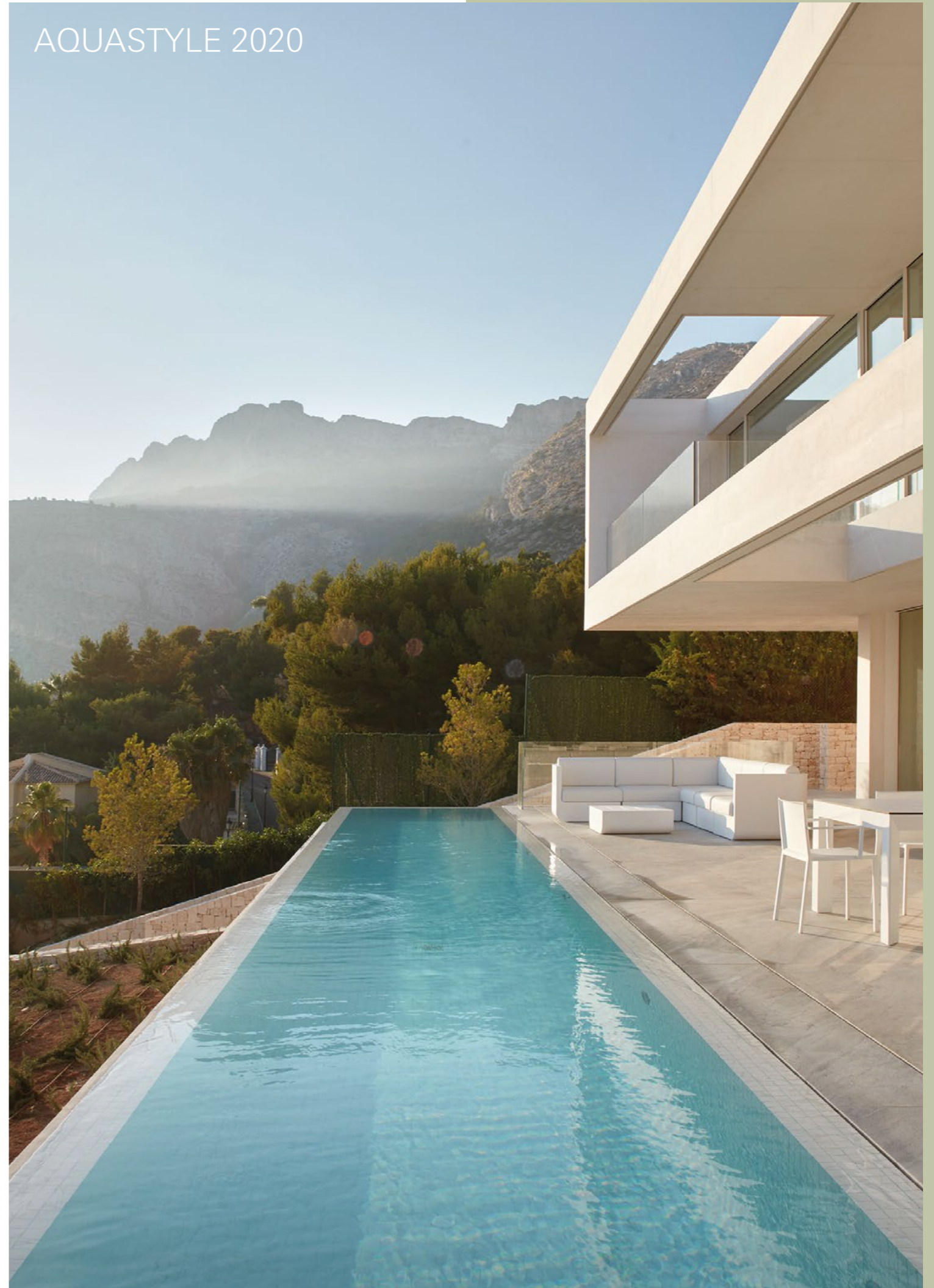



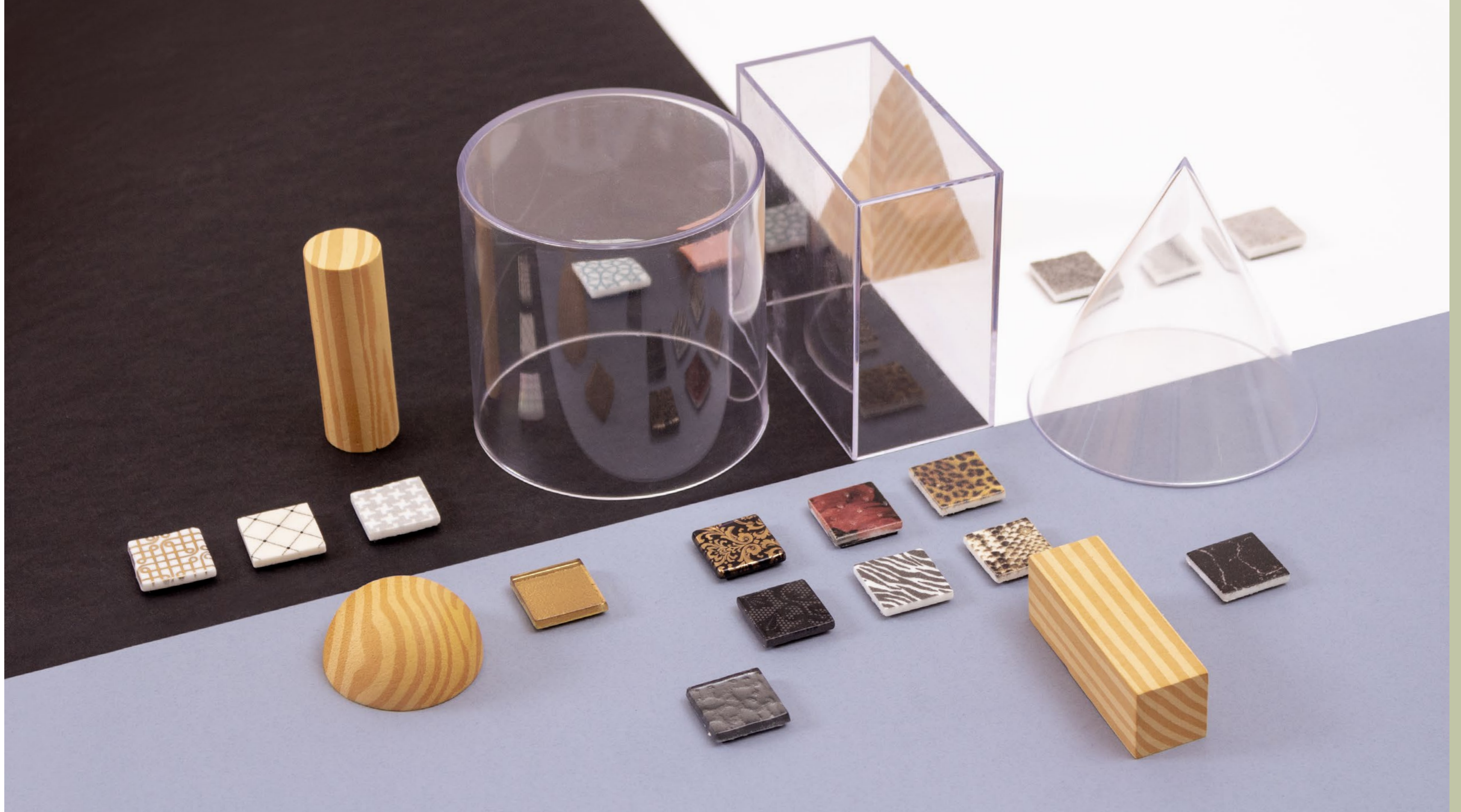

# CUSTOM

DESIGN





## DIGITAL PRINT

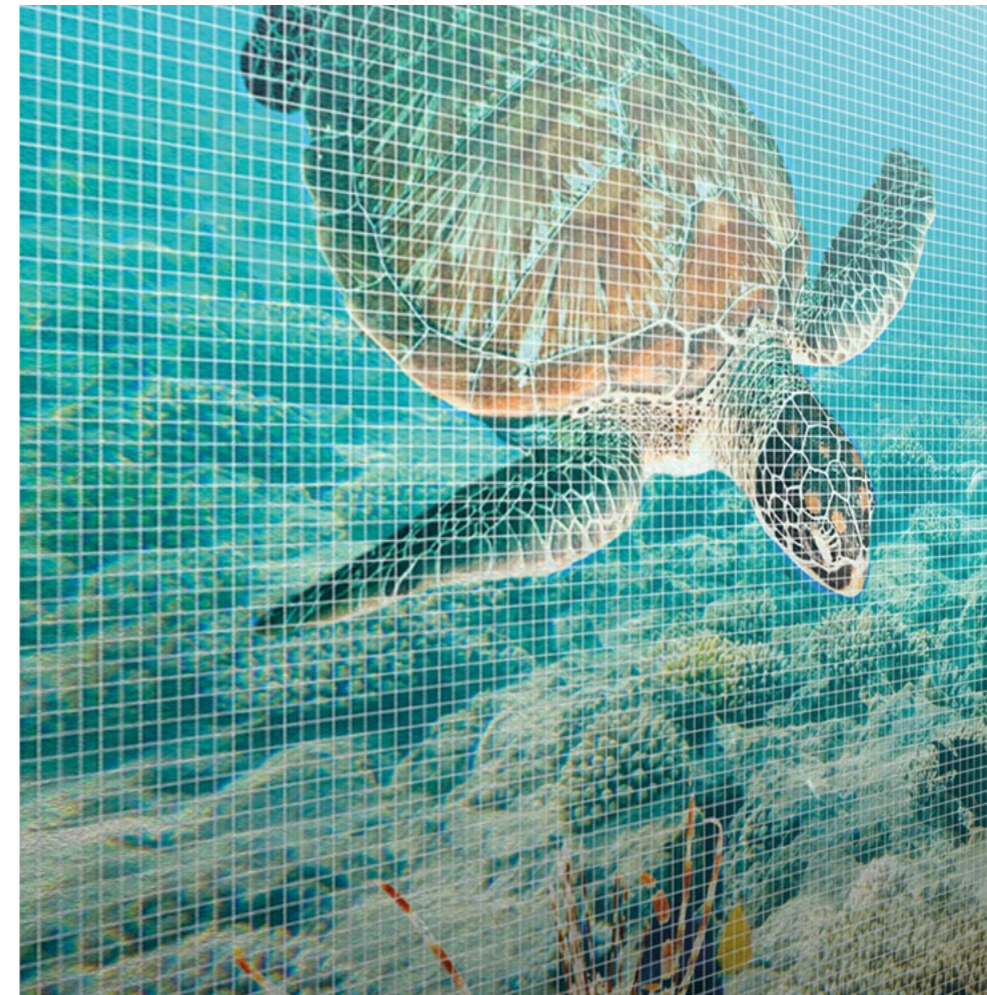

A digital printing system that reproduces any image or vector file on glass mosaic.

### Process

- Send a photo or a similar reference image.
- Choose the base material.
- Send the space's dimensions.

### Specifications

- Digital image in JPEG or TIFF extension, with a 300 dpi resolution.
- Vector file in EPS or AI format.

### Note

- If the image does not have the appropriate resolution, ONIX will suggest a similar alternative image.
- ONIX may submit a different estimate for very complex designs.

Es un sistema de impresión digital que reproduce sobre mosaico vítreo cualquier imagen o archivo vectorial.

### Proceso

- Envía tu propia fotografía o una imagen referencia similar.
- Elige el material base.
- Dinos el tamaño del decorado.

### Requisitos

- Imagen digital en formato JPEG o TIFF, con una resolución de 300 ppp.
- Archivo vectorial en formato EPS o AI.

### Consideraciones

- Si la imagen no tiene la resolución adecuada, ONIX propondrá una imagen alternativa similar.
- Para propuestas muy elaboradas, ONIX podrá presupuestar el diseño aparte.

C'est un système d'impression digitale qui reproduit les images ou fichiers vectoriels sur la mosaïque de verre.

### Processus

- Envoyez une photo ou une image de référence similaire.
- Choisissez le matériau de base.
- Envoyez les dimensions de l'espace.

### Conditions

- Image numérique dans un format JPEG ou TIFF, avec une résolution de 300 ppp.
- Format de fichier vectoriel EPS ou AI.

### Remarque

- Si l'image n'a pas la résolution appropriée, ONIX proposera une image alternative similaire.
- ONIX peut soumettre un devis séparé pour des designs très complexes.



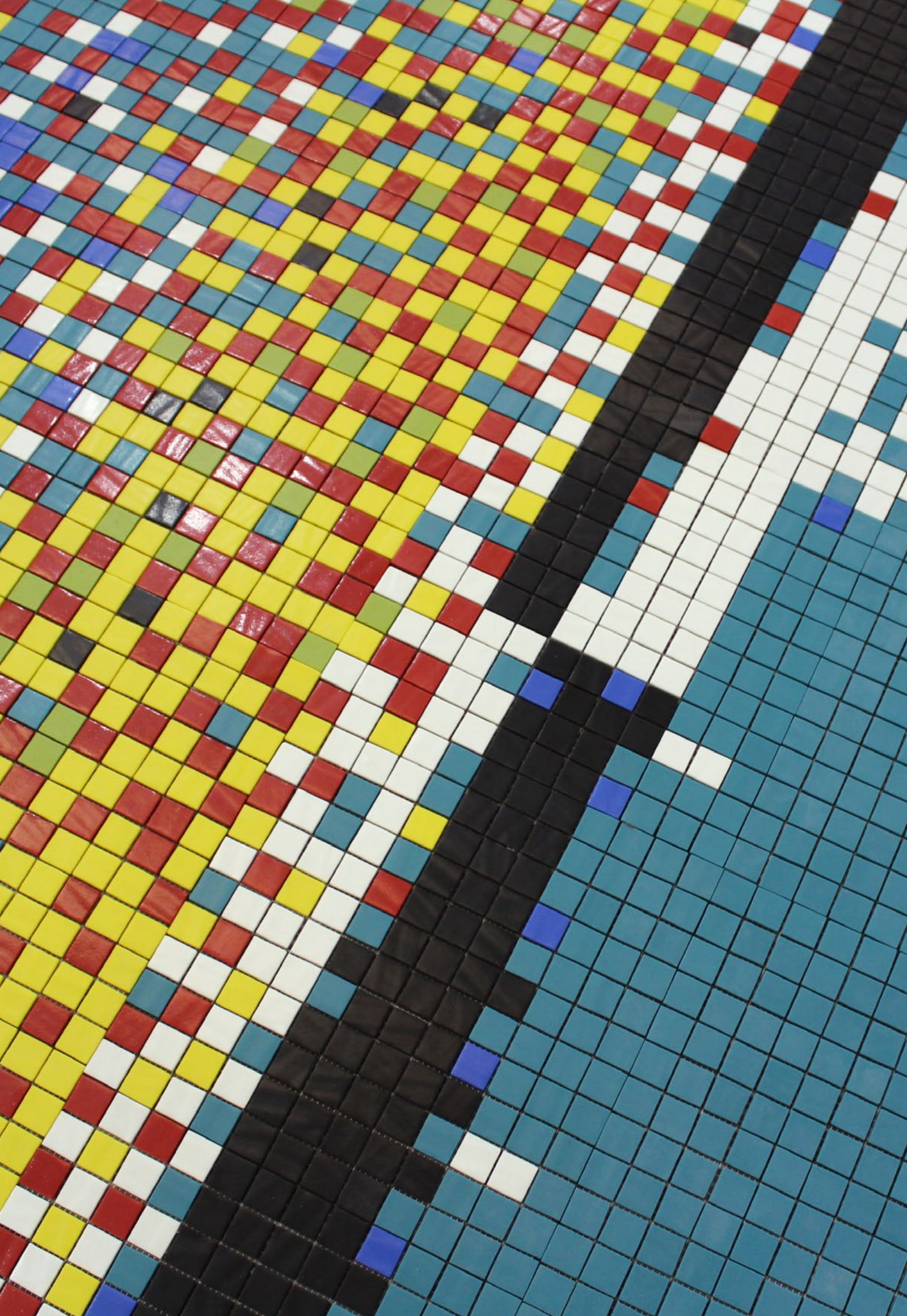

## PIXEL ART



Each tile is a pixel. We transform a design or image into a mosaic with 25x25 chips. Reproduce logos, transform images, borders, patterns...

### Process

- Give us a detailed description of your idea with a reference image.
- Submit your own design if you have it.
- Choose the materials (colors and textures).
- Send the space's dimensions.

### Specifications

- Detailed information.
- Reference image with a good definition of lines and colors.
- Vector file in EPS or AI format.

### Note

- The more detail is required, the bigger the decor should be.

Cada tesela, un pixel. Transformamos un diseño o imagen en un mosaico con piezas 25x25. Reproduce logotipos, transforma imágenes, cenefas, patrones...

### Proceso

- Explica bien tu idea con una imagen referencia.
- Envía tu propio diseño, si lo has desarrollado.
- Elige los materiales (colores y texturas).
- Dinos el tamaño del decorado.

### Requisitos

- Información detallada.
- Imagen de referencia con cierta definición en líneas y colores.
- Archivo vectorial en formato EPS o AI.

### Consideraciones

- Cuanto más detalle se requiera, más grande debe ser el decorado.

Chaque tesselle est un pixel. Nous transformons un design ou une image en une mosaïque avec des pièces de 25x25. Reproduisez des logos, transformez des images, des frises, des motifs...

### Processus

- Envoyez une description détaillée de votre idée avec une image de référence.
- Envoyez votre propre design.
- Choisissez les matériaux (couleurs et textures).
- Envoyez les dimensions de l'espace.

### Conditions

- Informations détaillées.
- Image de référence avec une bonne définition des lignes et des couleurs.
- Format de fichier vectoriel EPS ou AI.

### Remarque

- Plus le détail est important, plus le décor doit être grand.





Artistic Mosaic

## ARTISTIC MOSAIC

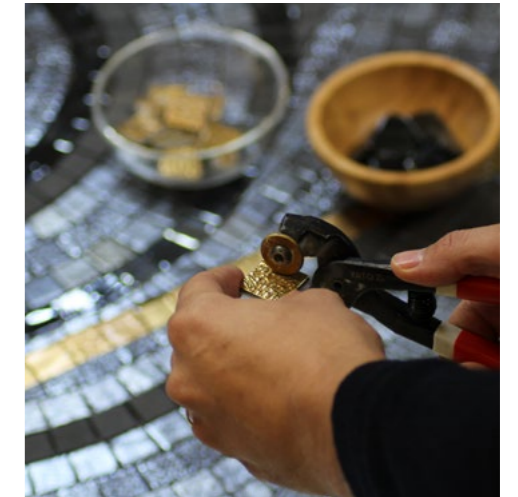
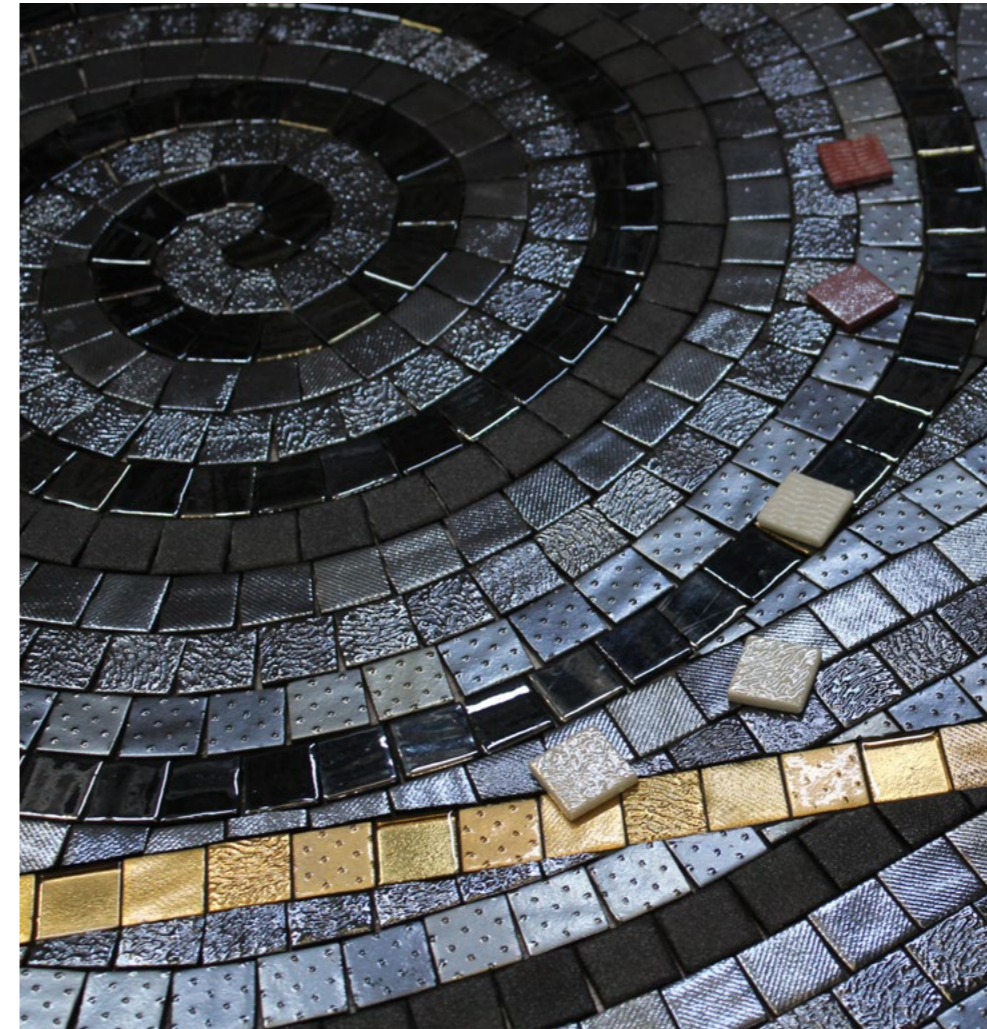

A craft technique of master mosaicists. Hand-cut tiles for highly detailed decors.

### Process

- Email us a detailed description of your idea with a reference image.
- Submit your own design if you have it.
- Send the space's dimensions.

### Specifications

- Detailed information.
- Reference image with a good definition of lines and colors.
- Vector file in EPS or AI format.

### Note

- The more detail is required, the bigger the decor should be.

Una técnica artesanal de los maestros mosaqueros. Fichas cortadas se crean decorados con increíble detalle.

### Proceso

- Explica bien tu idea con una imagen referencia.
- Envía tu propio diseño, si lo has desarrollado.
- Dinos el tamaño del decorado.

### Requisitos

- Información detallada.
- Imagen de referencia con una mínima definición en líneas y colores.
- Diseño archivo vectorial en formato EPS o AI.

### Consideraciones

- Cuanto más detalle se requiera, más grande debe ser el decorado.

Une technique artisanale des maîtres mosaïstes. Des tesselles taillées à la main pour des décors très minutieux.

### Processus

- Envoyez une description détaillée de votre idée avec une image de référence.
- Envoyez votre propre design.
- Envoyez les dimensions de l'espace.

### Conditions

- Informations détaillées.
- Image de référence avec une bonne définition des lignes et des couleurs.
- Format de fichier vectoriel EPS ou AI.

### Remarque

- Plus le détail est important, plus le décor doit être grand.





# TECHNICAL

INFORMATION



# TYPES OF SUPPORT



## Dots

### GREAT GRIP

The dot backing system allows up to 91% of surface free for the adhesive.

El soporte por puntos deja libre hasta el 91% de la superficie para adhesivo.

Le système de montage sur points laisse jusqu'à 91% de surface libre pour l'adhésion du ciment colle.

### FAST INSTALLATION

The size of 12 x 18 tesserae and the ease of installation allows up to a 27% time saving during the installation.

El mayor tamaño de 12 x 18 teselas y la facilidad de colocación de las láminas permite un ahorro del 27% del tiempo durante la instalación.

La dimension des plaques 12 x 18 permet un gain de temps de 27% durant la pose.

### HIGH RESISTANCE

The dot backing is damp proof, so it can be stored outside and it will remain unaltered.

Este sistema por puntos es insensible a la humedad. Es posible almacenarlo en el exterior permaneciendo inalterable.

Ce système ne craint pas l'humidité. Le matériel peut donc être stocké à l'extérieur sans que celui-ci ne subisse aucunes altérations.

### MAXIMUM FLEXIBILITY

Full adaptability to any type of surface: corners, curved, irregular finishes...

Total adaptabilidad a cualquier tipo de superficie: esquinas, curvadas, acabados irregulares...

Adaptabilité totale à tout type de surface: angles, finitions courbes, irrégulières...

### MINIMUM THICKNESS

An even thickness which conceals the surface of the grouting.

Un grosor homogéneo que se oculta por completo con el rejunte.

Une épaisseur homogène parfaitement cachée avec le rejoint du produit.

### VISUAL CONTROL

Unlike paper support, when you visualize the mosaic in the installation it is possible to create drawings and shapes.

Al contrario del soporte papel, al visualizar el mosaico en la instalación es posible crear dibujos y formas.

Contrairement au support papier, lorsque vous visualisez la mosaïque dans l'installation, il est possible de créer des dessins et des formes.

Polyurethane Dots



PVC Dots



## Mesh

### GREAT GRIP

Mesh mounting system leaves the 75% of the back free for the adhesive.

El sistema de soporte por malla deja libre el 75% de la superficie del mosaico para el adhesivo.

Le montage de la mosaïque sur filet laisse 75% de la surface libre pour le ciment colle.

Mesh



# IMPORTANT ADVISE

## PENTA GLASS MOSAIC:

This Artisan-edge glass mosaic is made with recycled glass pieces and may include irregular edges, rustic appearances, minimal imperfections or slight variations in sizing and squareness. These characteristics are inherent to this product due to the manufacturing process. The slight size or shape variations may affect the grout joint appearance, further enhancing the natural aspect of this product. Use constitutes acceptance.

El aspecto artesanal del mosaico vítreo en formato PENTA es una cualidad inherente en estos productos por el proceso de fabricación. Las teselas podrían incluir ciertas irregularidades y mínimas imperfecciones en el tamaño aportando cierta apariencia rústica más alejada de la perfección cuadriculada. Además la reducción de tamaño y variaciones de tono pueden afectar al aspecto del rejunte y modificar la apariencia natural de estos mosaicos. El uso constituye aceptación de esta advertencia.

## ONIX GLASS MOSAIC:

All ONIX 98% recycled glass mosaics series are made of molten glass. Molten glass characteristics may include irregular edges and small variations in size. These characteristics are inherent to the product and to the standard production. The small size and shape variations can affect the grout joint appearance and enhance the natural aspect of these products. Use constitutes acceptance.

Todas las series ONIX con un 98% de vidrio reciclado están hechas con vidrio molido. Esta materia posee unas características particulares que podría ocasionar ligeras irregularidades y variaciones de tamaño en las fichas. Es una cualidad inherente al producto y a la producción estándar. La reducción de tamaño y variaciones de tono pueden afectar al aspecto del rejunte y modificar la apariencia natural de estos mosaicos. El uso constituye aceptación de esta advertencia.



Made in Spain



98% Recycled Glass

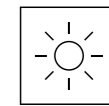

Unalterable Colour



High Resistance

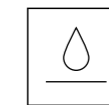

0% Water Absorption

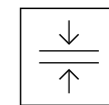

Minimum Thickness



Antislip C3/R11

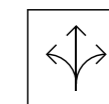

Maximum Flexibility





## PREPARATION OF THE BASE

The base on which the laying will be effected, must be perfectly smooth, uniform and white. A different colour damages the aesthetic look of the final result.



## THE GLUEING OPERATION

White C2 glue, as per EN12004, must be used. By using the smooth side of the trowel, the glue has to be spread out uniformly on the base (2 sq.m. approximately). By using the jagged side of the trowel (2 or 3 mm.), comb the glue.



## THE LAYING OF MOSAIC TILES

Adhere the sheet to the surface by pressing with a rubber trowel. It is important to make sure that the distance between one sheet and another is the same as the one among the tesseras so that all the joints look alike. We suggest to join the sheets when it comes to laying.



## GROUTING

Joints must be clean, dry and free from dust. The remains of adhesive, after laying, must be removed while it is still fresh. Use grouting paste, RG type, as per EN 13888, spread it out with a rubber trowel.



## CLEANING

Let it dry until the paste gets brightless, superficially, and then proceed to clean it with a sponge soaked in water. Once it gets dry, remove it with a dry cloth.

## PREPARACIÓN SOPORTE

El soporte sobre el cual se efectuará la colocación deberá estar perfectamente liso, uniforme y blanco. Un color diferente perjudica la estética del resultado final.

## OPERACIÓN ENCOLADO

Usar cemento cola tipo C2 color blanco, según EN 12004. Usando el lado liso de la llana extender el adhesivo uniformemente sobre el soporte (aprox. 2 m<sup>2</sup>). Con el lado dentado de la llana (2 ó 3 mm.) peinar el cemento cola.

## COLOCACIÓN MOSAICO

Adherir la hoja a la superficie presionando con una llanta de goma. Es importante asegurarse que la distancia entre hoja y hoja es igual a la que hay entre las teselas para que todas las juntas sean iguales entre sí. Aconsejamos trabar las hojas a la hora de su colocación.

## REJUNTADO

Las juntas deben estar limpias, secas y exentas de polvo. El adhesivo sobrante de la colocación se debe eliminar cuando esté todavía fresco. Utilizar pasta de rejuntar tipo RG según EN 13888, extendiéndolo con una llana de goma.

## LIMPIEZA

Dejar secar hasta que la masa pierda el brillo superficial y proceder a su limpieza con una esponja humedecida en agua. Una vez seco eliminar con un trapo seco.

## PRÉPARATION DE LA SURFACE

La surface sur laquelle on va effectuer la pose, doit être parfaitement lisse, uniforme et blanche. Une couleur différente nuit l'aspect esthétique du résultat final.

## OPÉRATION DE COLLAGE

Employer une colle de type C2 de couleur blanche, selon la norme EN12004. Tout en employant le côté lisse de la truelle, la colle doit être répartie uniformément sur la surface (2 m<sup>2</sup> approximativement). Tout en employant le côté denté de la truelle (2 ou 3 mm.), peigner la colle.

## LA POSE DE LA MOSAÏQUE

Adhérer la feuille à la surface tout en pressant avec une truelle en caoutchouc. Il est important de s'assurer que la distance entre chaque plaque est identique à celle entre les tesselles, de façon à ce que tous les joints soient égaux entre eux. Nous conseillons une pose des plaques en quinconce.

## REMPLISSAGE DES JOINTS

Les joints doivent être propres, secs et sans poussière. Le surplus de colle suite à la pose doit être éliminé lorsqu'il est encore frais. Utiliser un joint de type RG selon la norme EN13888, tout en répartissant avec une truelle en caoutchouc.

## NETTOYAGE

Laisser sécher jusqu'à ce que le joint perde son éclat superficiel et procéder à son nettoyage avec une éponge humide. Une fois que tout est sec, nettoyer avec un chiffon sec.

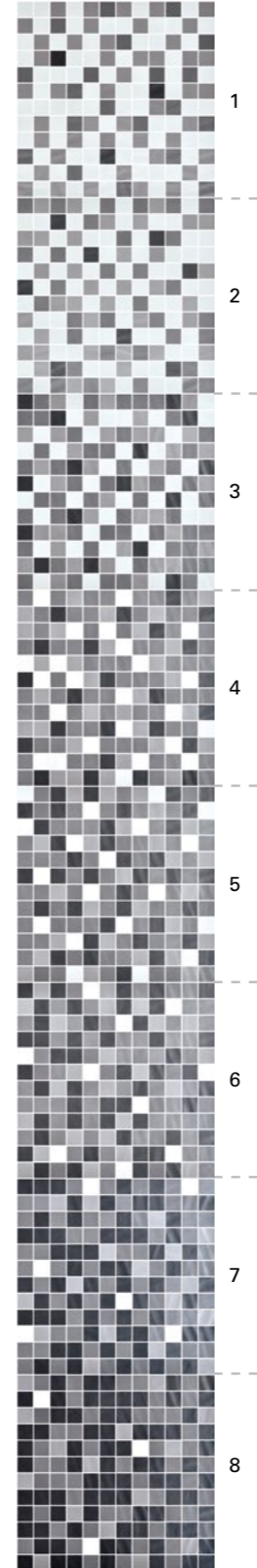

1 Module = 8 Sheets  
1 Módulo = 8 Láminas

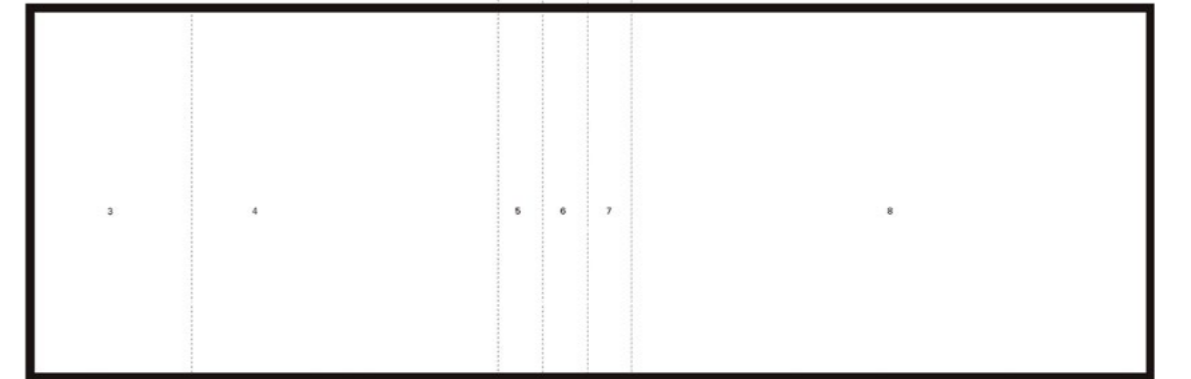
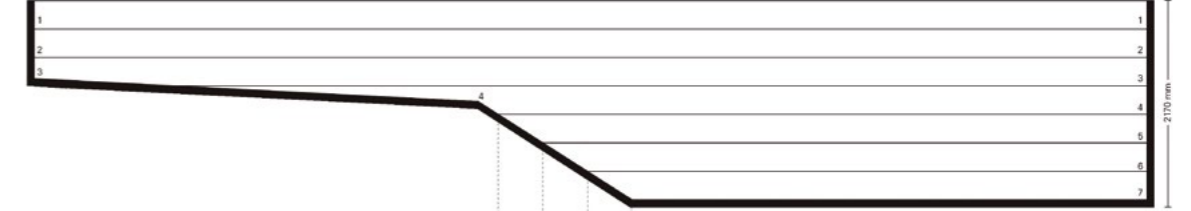

Use in swimming pool (example) | Aplicación en piscinas (ejemplo) | Emploi en piscine (exemple)

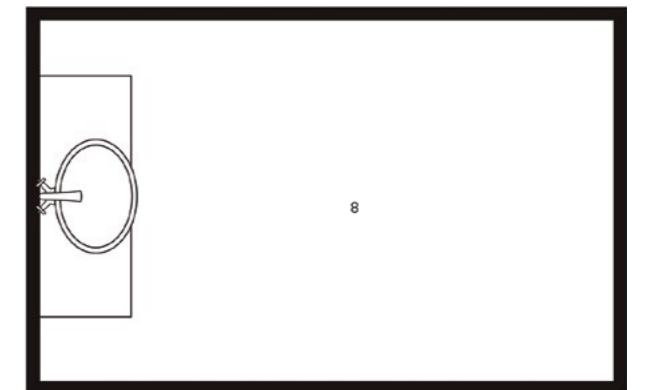
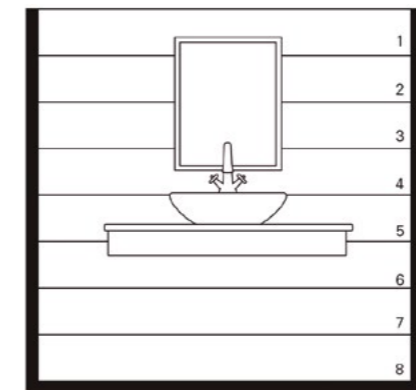

Use in bathroom (example) | Aplicación en baño (ejemplo) | Emploi en salle de bain (exemple)

Shading Blends are composed of several mixtures from the lightest to darkest. They are sold by module, 1 module = 8 sheets, (1 sheet per level from 1 to 8). Besides, 1 and 8 levels can be sold separately to complete floor, wall or roof. They are two different sizes of degrados depending on the support:

- Mesh support: 1 module: 2488 x 311 mm (0.77m<sup>2</sup> / 8.28 sqft)
- PVC support: 1 module: 2488 x 467 mm (1.16 m<sup>2</sup> / 12.5 sqft)

Los degradados están compuestos por mezclas que van desde la más clara a la más oscura. Se venden por modulo, 1 modulo = 8 laminas (1 lamina por nivel del 1 al 8). Además, los niveles n° 1 y n° 8, se venden separadamente para complementar en pavimento, revestimiento o techo. Destacar dos medidas de degradados según soporte del degradado:

- Soporte Malla: 1 modulo: 2488 x 311 mm (0.77m<sup>2</sup> / 8.28 sqft)
- Soporte PVC: 1 modulo: 2488 x 467 mm (1.16 m<sup>2</sup> / 12.5 sqft)

Les dégradés sont composés de mélanges qui vont du plus clairs au plus foncés. Ils se vendent par modules, 1 module = 8 plaques, (1 plaque par niveau du 1 au 8). De plus, les niveaux 1 et 8 se vendent aussi séparément pour compléter sols, murs et plafonds. Nous soulignons deux dimensions de dégradés suivant le support:

- Support filet: 1 module: 2488 x 311 mm (0.77m<sup>2</sup> / 8.28 sqft)
- Support PVC: 1 module: 2488 x 467 mm (1.16 m<sup>2</sup> / 12.5 sqft)



# ALPHABETICAL INDEX

NAME PAGE







ONIX<sup>®</sup>, founded in 1999 in Onda (Spain), is a world leading glass mosaic company. Within a few years, the company is the Europe's largest producer, has had sales presence in more than 100 countries, developed a wide variety of projects around the world and participated in the main international exhibitions.

The continuous aesthetic search combined with a significant technological potential have positioned this prestigious Spanish factory as the benchmark in the world of décor.

ONIX<sup>®</sup>, fundada en 1999 en Onda (España), es líder mundial en mosaico vítreo. En tan sólo unos años, es el mayor fabricante de mosaico vítreo de Europa, tiene presencia comercial en más de 100 países, realiza infinidad de proyectos por todo el mundo y participa en las principales ferias internacionales.

Su incesante búsqueda estética, sumada a su enorme potencial tecnológico, han posicionado esta prestigiosa firma española como un referente en el universo de la decoración.

ONIX<sup>®</sup>, une entreprise fondée en 1999 et située à Onda (Espagne), est leader mondial de mosaïque de verre. En quelques années, l'entreprise a réussi à conforter sa présence commerciale dans plus de 100 pays en développant notamment de nombreux projets à travers le monde et en participant aux principaux salons internationaux.

ONIX<sup>®</sup> est le premier fabricant de mosaïque en verre en Europe. Sa recherche constante de l'esthétique et son énorme potentiel technologique ont fait de cette prestigieuse marque espagnole une référence dans l'univers de la décoration.





## ONIX MOSAICO

ONIX CERÁMICA, S.L.  
AV. Real de Extremadura 23  
12200 Onda (Castellón – SPAIN)  
T. +34 964 776 287  
F. +34 964 776 284  
M. [onix@onixmosaic.com](mailto:onix@onixmosaic.com)

## ONIX USA

ONIX USA, LLC  
9450 NW 12 Street  
33172 Miami (USA)  
P. 305 599 3153  
F. 305 513 4634  
M. [customerservice@onixmosaic.com](mailto:customerservice@onixmosaic.com)

In the interest of maintaining constant improvements, ONIX Mosaico reserves the right to delete and amend, either totally or partially, any of the styles, colours, shapes, sizes, references and other technical specifications contained in this catalogue.

Due to the technical process of reproduction, colours printed are approximate, not exact. The photographs included in this catalogue are not contractual. The interpreting of the pictures will be according to designer's judgment. All the information and texts included in the catalogue keep under the reservation of possible errors. The catalogue is only an informative tool.

Para la mejora de nuestros productos, ONIX Mosaico se reserva el derecho de anular o modificar cualquiera de los modelos, colores, formatos, referencias y especificaciones técnicas contenidas en este catálogo.

Debido a los procesos técnicos de reproducción, los colores son aproximados, no exactos. Las fotografías expuestas en este catálogo no tienen un carácter contractual. La interpretación de las ilustraciones están en función del criterio del creador. Todos los textos e información que aparece en el catálogo quedan bajo la reserva de posibles errores. Este catálogo es una herramienta informativa.

Pour améliorer ses produits, ONIX Mosaico se réserve le droit d'annuler ou de modifier tout modèle, couleur, format, référence ou spécification technique figurant dans ce catalogue.

En raison des procédés techniques de reproduction, les couleurs sont approchantes et non exactes. Les photographies présentées dans ce catalogue ne sont pas contractuelles. L'interprétation des illustrations sera selon le critère du créateur. Tous les textes et information de ce catalogue restent sous réserve de possible erreurs. Ce catalogue est un outil informatif.





ONIX

[onixmosaic.com](http://onixmosaic.com)